

DrayTek

Vigor2760 Series High Speed VDSL2 Router



Your reliable networking solutions partner

User's Guide

V1.01

Vigor2760 Series High Speed VDSL2 Router User's Guide

Version: 1.01

Firmware Version: V3.7.5.1

(For updates, visit www.draytek.co.uk/support)

Date: May 12, 2014

Note: The product specification is subject to continuous evolution which may not always be reflected in current documentation. For the formal and supported current specification, please refer only to the web site at www.draytek.co.uk

Copyright Information

Copyright Declarations

Copyright© 2014 All rights reserved. This publication contains information that is protected by copyright. No part may be reproduced, transmitted, transcribed, stored in a retrieval system, or translated into any language without written permission from the copyright holders.

Trademarks

The following trademarks are used in this document:

- Microsoft is a registered trademark of Microsoft Corp.
- Windows, Windows 95, 98, Me, NT, 2000, XP, Vista and Explorer are trademarks of Microsoft Corp.
- Apple and Mac OS are registered trademarks of Apple Inc.
- Other products may be trademarks or registered trademarks of their respective manufacturers.

Safety Instructions and Approval

Safety Instructions

- Read the installation guide thoroughly before you set up the router.
- The router is a complicated electronic unit that may be repaired only by authorized and qualified personnel. Do not try to open or repair the router yourself.
- Do not place the router in a damp or humid place, e.g. a bathroom.
- The router should be used in a sheltered area, within a temperature range of +5 to +40 Celsius.
- Do not expose the router to direct sunlight or other heat sources. The housing and electronic components may be damaged by direct sunlight or heat sources.
- Do not deploy the cable for LAN connection outdoor to prevent electronic shock hazards.
- Keep the package out of reach of children.
- When you want to dispose of the router, please follow local regulations on conservation of the environment.

Warranty

We warrant to the original end user (purchaser) that the router will be free from any defects in workmanship or materials for a period of two (2) years from the date of purchase from the dealer. Please keep your purchase receipt in a safe place as it serves as proof of date of purchase. During the warranty period, and upon proof of purchase, should the product have indications of failure due to faulty workmanship and/or materials, we will, at our discretion, repair or replace the defective products or components, without charge for either parts or labor, to whatever extent we deem necessary to restore the product to proper operating condition. Any replacement will consist of a new or re-manufactured functionally equivalent product of equal value, and will be offered solely at our discretion. This warranty will not apply if the product is modified, misused, tampered with, damaged by an act of God, or subjected to abnormal working conditions. The warranty does not cover the bundled or licensed software of other vendors. Defects which do not significantly affect the usability of the product will not be covered by the warranty. We reserve the right to revise the manual and online documentation and to make changes from time to time in the contents hereof without obligation to notify any person of such revision or changes. Warranty service is 'RTB' (return to base), not advance or on-site. You can subscribe to VigorCare within 30 days of purchase – see www.draytek.co.uk/vigorcare

Mailing List

Users in the UK/Ireland are recommended to sign up to a users' newsletter for news, updates, hits & tips and offers. See www.draytek.co.uk/mailling-list

Firmware & Tools Updates

Due to the continuous evolution of DrayTek technology, all routers will be regularly upgraded. Please consult the DrayTek web site for more information on newest firmware, tools and documents. <http://www.draytek.co.uk>

European Community Declarations

Manufacturer: DrayTek Corp.
Address: No. 26, Fu Shing Road, Hukou Township, Hsinchu Industrial Park, Hsinchu County, Taiwan 303
Product: Vigor2760 Series Router

DrayTek Corp. declares that Vigor2760 Series of routers are in compliance with the following essential requirements and other relevant provisions of R&TTE 1999/5/EC, ErP 2009/125/EC and RoHS 2011/65/EU.

The product conforms to the requirements of Electro-Magnetic Compatibility (EMC) Directive 2004/108/EC by complying with the requirements set forth in EN55022/Class B and EN55024/Class B.

The product conforms to the requirements of Low Voltage (LVD) Directive 2006/95/EC by complying with the requirements set forth in EN60950-1.

This product is designed for the DSL and 2.4GHz/5GHz WLAN network throughout the EC region. Please see the user manual for the applicable networks on your product.

Regulatory Information

Federal Communication Commission Interference Statement

This equipment has been tested and found to comply with the limits for a Class B digital device, pursuant to Part 15 of the FCC Rules. These limits are designed to provide reasonable protection against harmful interference in a residential installation. This equipment generates, uses and can radiate radio frequency energy and, if not installed and used in accordance with the instructions, may cause harmful interference to radio communications. However, there is no guarantee that interference will not occur in a particular installation. If this equipment does cause harmful interference to radio or television reception, which can be determined by turning the equipment off and on, the user is encouraged to try to correct the interference by one of the following measures:

- Reorient or relocate the receiving antenna.
- Increase the separation between the equipment and receiver.
- Connect the equipment into an outlet on a circuit different from that to which the receiver is connected.
- Consult the dealer or an experienced radio/TV technician for help.

This device complies with Part 15 of the FCC Rules. Operation is subject to the following two conditions:

- (1) This device may not cause harmful interference, and
- (2) This device may accept any interference received, including interference that may cause undesired operation.

RF Exposure Warning

This equipment must be installed and operated in accordance with provided instructions and the antenna(s) used for this transmitter must be installed to provide a separation distance of at least 20 cm from all persons and must not be co-located or operating in conjunction with any other antenna or transmitter. End-users and installers must be provided with antenna installation instructions and transmitter operating conditions for satisfying RF exposure compliance.

Caution

Any changes or modifications not expressly approved by the grantee of this device could void the user's authority to operate the equipment.

The antenna/transmitter should be kept at least 20 cm away from human body.

Please visit <http://www.draytek.com/user/SupportDLRTTECE.php>



Table of Contents

1

| | |
|----------------------------------------|----------|
| Introduction..... | 1 |
| 1.1 Features..... | 2 |
| 1.2 Package and Content | 4 |
| 1.3 LED Indicators and Connectors..... | 5 |
| 1.3.1 For Vigor2760 | 5 |
| 1.3.2 For Vigor2760n | 7 |
| 1.3.3 For Vigor2760Vn..... | 9 |
| 1.4 Hardware Installation | 11 |
| 1.5 Printer Installation | 12 |

2

| | |
|--------------------------------------------------|-----------|
| Quick Setup..... | 21 |
| 2.1 Accessing Web Page..... | 21 |
| 2.2 Changing Password..... | 22 |
| 2.3 Introducing Dashboard | 23 |
| 2.3.1 Virtual Panel..... | 24 |
| 2.3.2 Name with a Link | 24 |
| 2.3.3 Quick Access for Common Used Menu..... | 24 |
| 2.3.4 GUI Map..... | 26 |
| 2.3.5 Web Console | 27 |
| 2.3.6 Config Backup | 27 |
| 2.3.7 Logout..... | 28 |
| 2.4 Configuring WAN for Accessing Internet | 28 |
| 2.5 Online Status..... | 30 |
| 2.5.1 Physical Connection | 30 |
| 2.5.2 Virtual WAN | 32 |
| 2.6 Saving Configuration | 33 |

3

| | |
|-----------------------------------------------------|-----------|
| Advanced Configuration..... | 35 |
| 3.1 WAN..... | 35 |
| 3.1.1 Basics of Internet Protocol (IP) Network..... | 35 |
| 3.1.2 General Setup..... | 37 |
| 3.1.3 Internet Access | 42 |
| 3.1.4 Multi-PVC..... | 69 |
| 3.2 LAN | 75 |
| 3.2.1 Basics of LAN | 75 |
| 3.2.2 General Setup..... | 77 |
| 3.2.3 VLAN..... | 84 |

| | |
|---------------------------------------|-----|
| 3.2.4 LAN Port Mirror | 87 |
| 3.2.5 Web Portal Setup..... | 88 |
| 3.3 NAT | 89 |
| 3.3.1 Port Redirection | 90 |
| 3.3.2 DMZ Host..... | 94 |
| 3.3.3 Open Ports..... | 97 |
| 3.3.4 Port Triggering | 99 |
| 3.4 Firewall..... | 102 |
| 3.4.1 Basics for Firewall..... | 102 |
| 3.4.2 General Setup..... | 104 |
| 3.4.3 Filter Setup..... | 108 |
| 3.4.4 DoS Defense | 116 |
| 3.5 Objects Settings..... | 120 |
| 3.5.1 IP Object | 120 |
| 3.5.2 IP Group..... | 123 |
| 3.5.3 IPv6 Object | 125 |
| 3.5.4 IPv6 Group..... | 127 |
| 3.5.5 Service Type Object | 128 |
| 3.5.6 Service Type Group..... | 130 |
| 3.5.7 Keyword Object | 132 |
| 3.5.8 Keyword Group..... | 134 |
| 3.5.9 File Extension Object..... | 135 |
| 3.5.10 SMS/Mail Service Object..... | 137 |
| 3.5.11 Notification Object..... | 142 |
| 3.6 CSM Profile..... | 144 |
| 3.6.1 APP Enforcement Profile | 145 |
| 3.6.2 URL Content Filter Profile..... | 148 |
| 3.6.3 Web Content Filter Profile..... | 152 |
| 3.6.4 DNS Filter | 156 |
| 3.7 Bandwidth Management | 158 |
| 3.7.1 Sessions Limit..... | 158 |
| 3.7.2 Bandwidth Limit | 160 |
| 3.7.3 Quality of Service..... | 162 |
| 3.7.4 APP QoS..... | 171 |
| 3.8 Applications..... | 173 |
| 3.8.1 Dynamic DNS | 173 |
| 3.8.2 LAN DNS | 176 |
| 3.8.3 Schedule | 179 |
| 3.8.4 UPnP..... | 182 |
| 3.8.5 IGMP..... | 184 |
| 3.8.6 Wake on LAN..... | 185 |
| 3.8.7 SMS / Mail Alert Service | 186 |
| 3.8.8 Bonjour..... | 188 |
| 3.9 VPN and Remote Access | 191 |
| 3.9.1 LAN to LAN | 191 |
| 3.9.2 Connection Management..... | 197 |
| 3.10 Certificate Management..... | 198 |
| 3.10.1 Local Certificate | 198 |
| 3.10.2 Trusted CA Certificate | 200 |
| 3.10.3 Certificate Backup..... | 201 |
| 3.11 VoIP..... | 202 |

| | |
|------------------------------------|-----|
| 3.11.1 DialPlan..... | 204 |
| 3.11.2 SIP Accounts | 213 |
| 3.11.3 Phone Settings | 217 |
| 3.11.4 Status..... | 222 |
| 3.12 Wireless LAN | 224 |
| 3.12.1 Basic Concepts..... | 224 |
| 3.12.2 General Setup..... | 226 |
| 3.12.3 Security | 228 |
| 3.12.4 Access Control..... | 231 |
| 3.12.5 WPS..... | 232 |
| 3.12.6 WDS..... | 235 |
| 3.12.7 Advanced Setting..... | 239 |
| 3.12.8 WMM Configuration | 241 |
| 3.12.9 AP Discovery | 243 |
| 3.12.10 Station List..... | 244 |
| 3.13 USB Application | 245 |
| 3.13.1 USB General Settings..... | 245 |
| 3.13.2 USB User Management..... | 246 |
| 3.13.3 File Explorer..... | 247 |
| 3.13.4 USB Device Status | 249 |
| 3.13.5 Modem Support List..... | 250 |
| 3.14 System Maintenance | 251 |
| 3.14.1 System Status..... | 251 |
| 3.14.2 TR-069 | 253 |
| 3.14.3 Administrator Password..... | 254 |
| 3.14.4 User Password | 255 |
| 3.14.5 Login Page Greeting..... | 257 |
| 3.14.6 Configuration Backup | 259 |
| 3.14.7 Syslog/Mail Alert..... | 261 |
| 3.14.8 Time and Date | 264 |
| 3.14.9 SNMP..... | 265 |
| 3.14.10 Management..... | 267 |
| 3.14.11 Reboot System | 270 |
| 3.14.12 Firmware Upgrade | 271 |
| 3.14.13 DSL Firmware Upgrade..... | 272 |
| 3.14.14 Activation | 272 |
| 3.15 Diagnostics | 273 |
| 3.15.1 Dial-out Triggering | 274 |
| 3.15.2 Routing Table | 275 |
| 3.15.3 ARP Cache Table | 276 |
| 3.15.4 IPv6 Neighbour Table | 276 |
| 3.15.5 DHCP Table..... | 277 |
| 3.15.6 NAT Sessions Table | 278 |
| 3.15.7 Ping Diagnosis..... | 279 |
| 3.15.8 Data Flow Monitor..... | 280 |
| 3.15.9 Traffic Graph..... | 282 |
| 3.15.10 Trace Route | 283 |
| 3.15.11 Syslog Explorer..... | 284 |
| 3.15.12 IPv6 TSPC Status..... | 286 |

4

Tutorials and Applications.....287

| | |
|------------------------------------------------------------------|-----|
| 4.1 How to configure settings for IPv6 Service in Vigor2760..... | 287 |
|------------------------------------------------------------------|-----|

| | |
|-----------------------------------------------------------------------------------------------------------|-----|
| 4.2 How can I get the files from USB storage device connecting to Vigor router?..... | 299 |
| 4.3 How to Build a LAN-to-LAN VPN Between Remote Office and Headquarter via IPsec Tunnel (Main Mode)..... | 301 |
| 4.4 How to Optimize the Bandwidth through QoS Technology..... | 305 |
| 4.5 QoS Setting Example | 309 |
| 4.6 How to Send a Notification to Specified Phone Number via SMS Service in WAN Disconnection | 314 |
| 4.7 How to Create an Account for MyVigor..... | 318 |
| 4.7.1 Create an Account via Vigor Router | 318 |
| 4.7.2 Create an Account via MyVigor Web Site | 322 |
| 4.8 How to Configure Certain Computers Accessing to Internet..... | 326 |
| 4.9 How to Block Facebook Service Accessed by the Users via Web Content Filter / URL Content Filter | 331 |

5

| | |
|----------------------------------------------------------------------------|------------|
| Trouble Shooting..... | 337 |
| 5.1 Check if the Hardware Status Is OK | 337 |
| 5.2 Check If the Network Connection Settings on Your Computer are OK | 338 |
| 5.3 Pinging the Router from Your Computer..... | 341 |
| 5.4 Checking if the ISP Settings are OK..... | 342 |
| 5.5 Problems with 3G/4G Network Connection | 342 |
| 5.6 Backing to Factory Default Setting If Necessary | 343 |
| 5.7 Getting further help | 344 |
| 5.8 Keep up to date..... | 345 |
| 5.9 Firmware Updates | 345 |

1

Introduction

Vigor2760 series is a VDSL2 and ADSL2+ router, alternatively supporting Ethernet-Based Internet WAN connections ('Delight' edition onwards). It integrates QoS, NAT session/bandwidth management to help users control works well with large bandwidth.

With good performance and secured broadband connectivity provided by Vigor 2760 series, you can simultaneously engage these bandwidth-intensive applications, such as high-definition video streaming, online gaming, and Internet telephony / access.

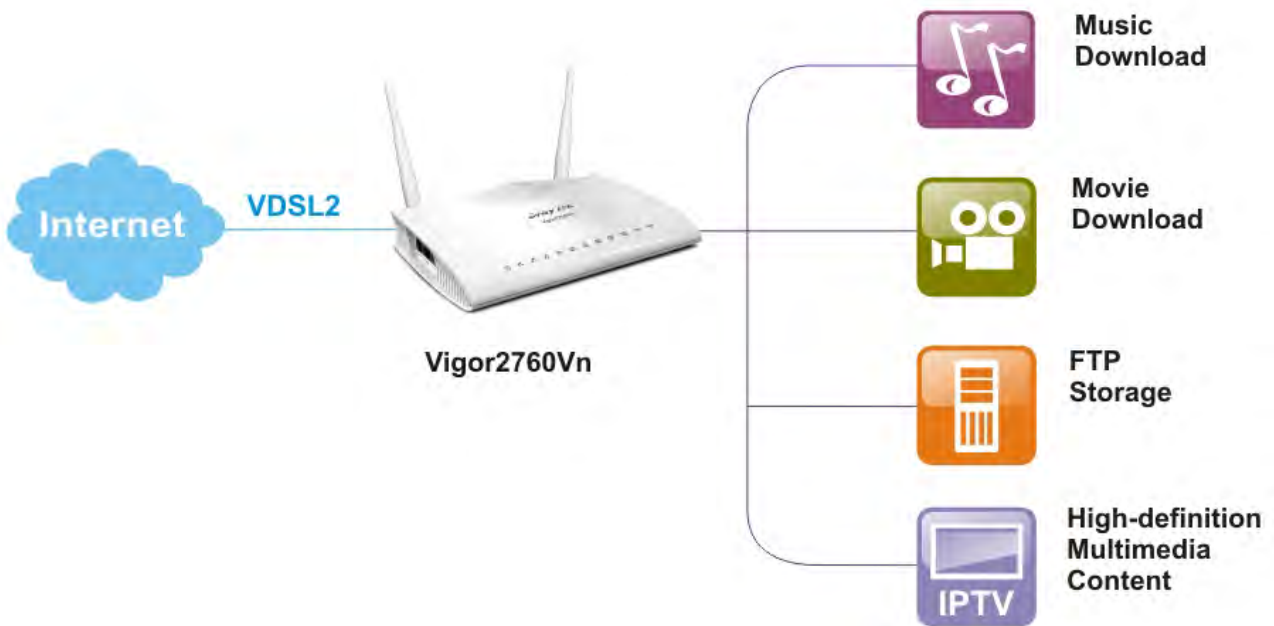

1.1 Features

| | |
|-----------------------------|-----------------------------------------------------------------------------------------------------------------------------------------------------------------------------------------------------------------------------------------------------------------------------------------------------------------------------------------------------------------------------|
| ADSL2/2+ & VDSL2 | Compliant with ITU-T G.993.2 & G.997.1 Support Band Plan 998 & 997 Support Annex A / Annex M VDSL2 Profile 8a/8b/8c/8d/12a/12b/17a/30a Capability Fall-back to ADSL2/2+ Multi-VLAN Multi-PVC |
| Internet | Support IPv4 & IPv6 Support PPPoE/PPPoA Support DHCP/Static IP Internet connection over 3G/4G USB Dongle Multi-VLAN/Multi-PVC for triple play |
| VPN | 2 simultaneous outgoing VPN Tunnels (to main office/HQ host) VPN Passthrough (PPTP/L2TP/IPsec) IPsec Main/Aggressive Mode IKE Authentication (PSK & X.509) PPTP MPPE L2TP over IPsec |
| Security | Object-based Firewall MAC Address Filter SPI (Stateful Packet Inspection) DoS/DDoS Prevention IM/P2P Applications Filter URL Content Filter Global View Web Content Filter |
| NAT/Routing | DMZ Host Port Forwarding & Redirection Route Policy |
| Network Feature | <ul style="list-style-type: none">● LAN Port Mirror● Bandwidth/Session Management● QoS by IP, Port, Applications● Dynamic DNS● LAN DNS● UPnP● IGMP proxy & snooping● Wake on LAN● Bonjour● Printer Sharing● FTP Server for File Sharing by a USB Memory (FAT32) |
| System Maintenance | <ul style="list-style-type: none">● Web Syslog● HTTP/HTTPS User Interface |

| | |
|------------------------------|-------------------------------------------------------------------------------------------------------------------------------------------------------------------------------------------------------------------------------------------------------------------------------------------------------------------------------------------------------------------------------------------------------------------------------------------------------------------------------------------------------------------------------------------------------------------------------------------------------------------------------------------------------------------------------------------------------------------------------------------------------------------------------------------------------------------------------------------------------------------------------------------------------------------------------------------------------------|
| | <ul style="list-style-type: none"> ● CLI over Telnet/SSH/Web UI ● Configuration Backup/Restore ● Administrator Access Control ● Restricted User Mode ● Flow Monitor ● Built-in Diagnostic Function ● E-mail/SMS Alert ● SNMP v1/v2c ● TR-069 (Compliance with VigorACS SI) |
| Wireless AP (n model) | <ul style="list-style-type: none"> ● Support 2T2R 2.4GHz, Single Band ● 802.11n Compliant ● 64/128-bit WEP, WPA/WPA2 ● WDS (Wireless Distribution System) ● MAC Address Access Control ● WPS ● Wireless Client List ● Access Point Discovery ● Hidden SSID ● Multiple SSID ● WMM |
| VoIP (V model) | <ul style="list-style-type: none"> ● Protocol: SIP, RTP/RTCP ● 6 SIP Registrars ● G.168 Line Echo-cancellation ● VoIP Status ● PSTN Loop Through ● Codec Features : <ul style="list-style-type: none"> ➢ G.711 A/μ law ➢ G.723.1 ➢ G.726 ➢ G.729 A/B ➢ VAD/CNG ● DTMF Relay : <ul style="list-style-type: none"> ➢ In Band ➢ Out Band (RFC-2833) ➢ SIP Info ● Supplemental Services : <ul style="list-style-type: none"> ➢ Call Hold/Retrieve ➢ Call Waiting ➢ CLIR (Calling Line Identification Restriction) ➢ Call Forwarding (Always, Busy and No Answer) ➢ Call Barring (Incoming / Outgoing) ➢ Hotline ➢ DND (Do Not Disturb) ➢ Call Transfer ➢ MWI (Message Waiting Indicator) (RFC-3842) |

1.2 Package and Content

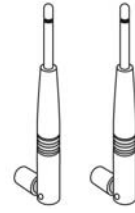

1 Antenna (n models)

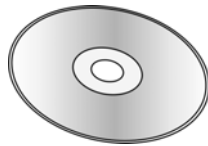

2 CD

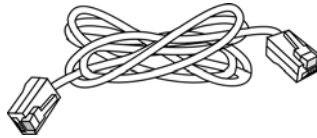

3 RJ-45 Cable (Ethernet)



4 Quick Start Guide

- 5 Use only the supplied PSU suitable for your country. If you lose it, obtain an original replacement only from a DrayTek dealer. Using unapproved accessories can damage your unit and invalidates your warranty.

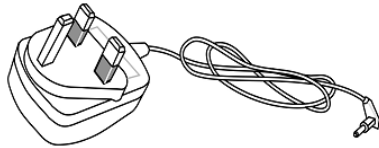

UK-type Power Adapter



For the Vigor 2760Vn model, you will additionally have two RJ11-BT adaptors (to plug in phones) and an RJ11-BT plug cable, for connecting to the analogue phone line for voice calls.

1.3 LED Indicators and Connectors

Before you use the Vigor router, we recommend that you get acquainted with the LED indicators and connectors:

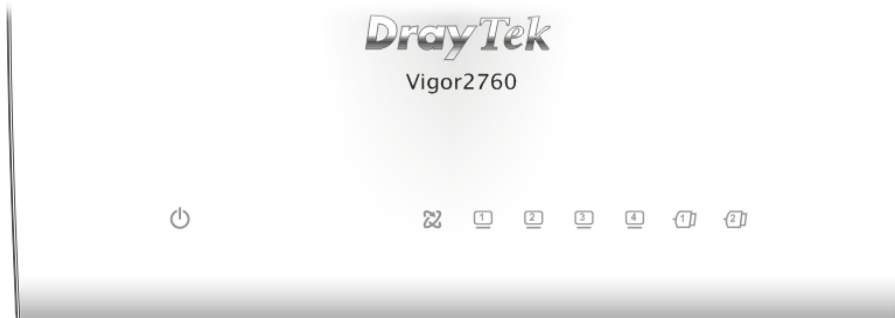
1.3.1 For Vigor2760



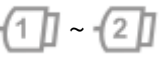

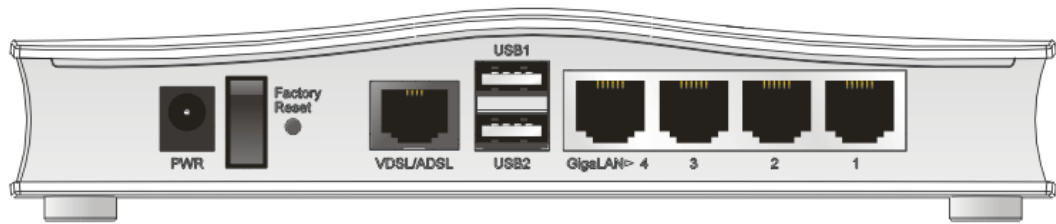

| LED | Status | Explanation |
|----------------------------------------------------------------------------------------------------|--------------------|------------------------------------------------|
|  (ACT) | Blinking | The router is powered on and running normally. |
| | Off | The router is powered off. |
|  DSL (Green) | On | The DSL port is connected. |
| | Blinking (Slowly) | The router is ready. |
| | Blinking (Quickly) | The connection is training. |
|  LAN1/2/3/4 | On (Green) | The port is connected. |
| | Blinking (Green) | The data is transmitting. |
|  USB1/2 | On | A USB device is connected and active. |

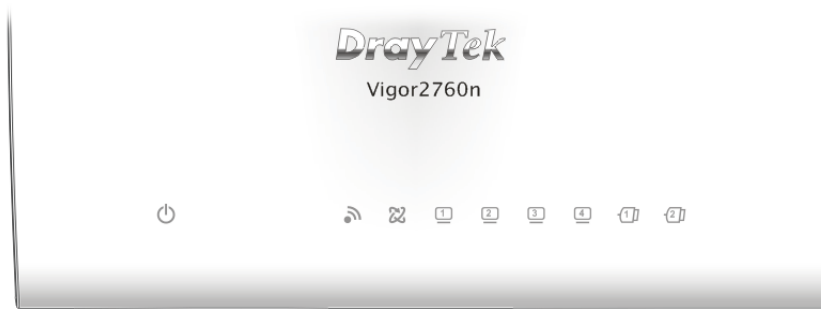

| Interface | Description |
|----------------------|---------------------------------------------------------------------------------------------------------------------------------------------------------------------------------------------------------------------------------------------------------------------------------------|
| PWR | Connector for power adapter. |
| I / O | Power switch. |
| Factory Reset | Restore the default settings. Usage: Turn on the router (ACT LED is blinking). Press the hole and keep for more than 5 seconds. When you see the ACT LED begins to blink rapidly than usual, release the button. Then the router will restart with the factory default configuration. |
| VDSL/ADSL | RJ11 connector for accessing the Internet. |
| USB (1-2) | Connector for USB storage device, printer or 3G/4G modem (WAN3) |
| LAN (1-4) Or WAN2 | RJ-45 Gigabit Ethernet connectors for local network devices. When WAN2 is enabled, LAN Port 4 becomes WAN2 (Ethernet) and WAN1 (RJ11) is disabled. |

1.3.2 For Vigor2760n



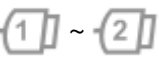

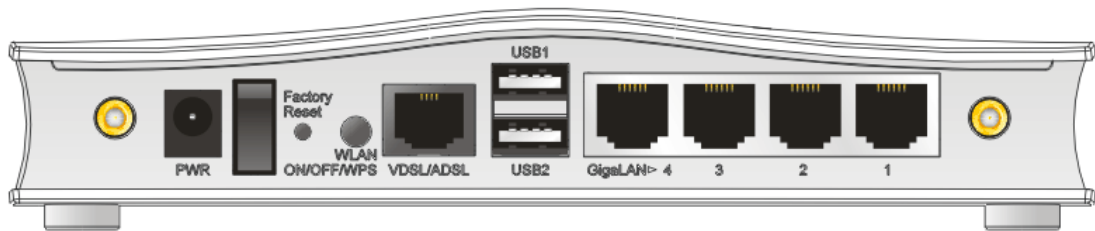



| LED | Status | Explanation |
|-------------------------------------------------------------------------------------------------------------------|--------------------|---------------------------------------------------------------------------|
|  (Activity) | Blinking | The router is powered on and running normally. |
| | Off | The router is powered off. |
|  (Wireless LAN On/Off/WPS) | On (Green) | The wireless access point is ready. |
| | Blinking (Green) | The data is transmitting via wireless connection. |
| | Blinking (Orange) | Blinks with one second cycle for two minutes. The WPS function is active. |
| | Off | The wireless access point is turned off. |
|  DSL (Green) | On | The DSL port is connected. |
| | Blinking (Slowly) | The router is ready. |
| | Blinking (Quickly) | The router is trying to connect to Internet. |
|  LAN1/2/3/4 | On | The port is connected. |
| | Blinking (Green) | The data is transmitting. |
|  USB1/2 | On | A USB device is connected and active. |

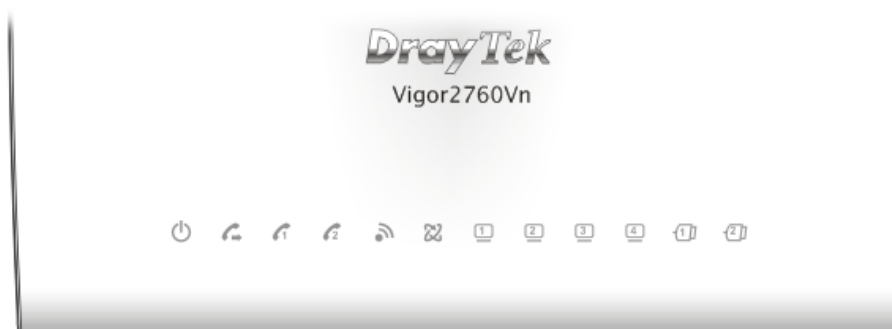

| Interface | Description |
|------------------------|---------------------------------------------------------------------------------------------------------------------------------------------------------------------------------------------------------------------------------------------------------------------------------------------|
| PWR | Connector for power adapter. |
| I / O | Power switch. |
| Factory Reset | Restore the default settings. Usage: Turn on the router (ACT LED is blinking). Press the hole and keep for more than 5 seconds. When you see the ACT LED begins to blink rapidly than usual, release the button. Then the router will restart with the factory default configuration. |
| WLAN ON/OFF/WPS | <p>WLAN WPS - Press this button for 2 seconds to wait for client device making network connection through WPS. When the LED lights up, the WPS connection will be on.</p> <p>WLAN ON/OFF - Press the button once to enable (WLAN LED on) or disable (WLAN LED off) wireless connection.</p> |
| VDSL/ADSL | RJ-11 connector for accessing the Internet (WAN1) |
| USB (1-2) | Connector for USB storage device, printer or 3G/4G modem (WAN3) |
| LAN (1-4) (or WAN2) | RJ-45 Gigabit Ethernet connectors for local network devices. When WAN2 is enabled, LAN Port 4 becomes WAN2 (Ethernet) and WAN1 (RJ11) is disabled. |

1.3.3 For Vigor2760Vn

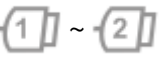

| LED | Status | Explanation |
|------------------------------------------------------------------------------------------------------------------|--------------------|---------------------------------------------------------------------------------------------------------------------|
|  (ACT) | Blinking | The router is powered on and running normally. |
| | Off | The router is powered off. |
|  (LINE) | On | A PSTN phone call comes (in and out). However, when the phone call is disconnected, the LED will be off for awhile. |
| | Off | There is no PSTN phone call. |
|  (Phone1/Phone2) | On | The phone connected to this port is off-hook. |
| | Off | The phone connected to this port is on-hook. |
| | Blinking | A phone call comes. |
|  (Wireless LAN On/Off/WPS) | On (Green) | The wireless access point is ready. |
| | Blinking (Green) | The data is transmitting via wireless connection. |
| | Blinking (Orange) | Blinks with one second cycle for two minutes. The WPS function is active. |
| | Off | The wireless access point is turned off. |
|  DSL (Green) | On | The DSL port is connected. |
| | Blinking (Slowly) | The router is ready. |
| | Blinking (Quickly) | The router is trying to connect to Internet. |
|  LAN1/2/3/4 | On | The port is connected. |
| | Blinking (Green) | The data is transmitting. |
|  USB1/2 | On | A USB device is connected and active. |

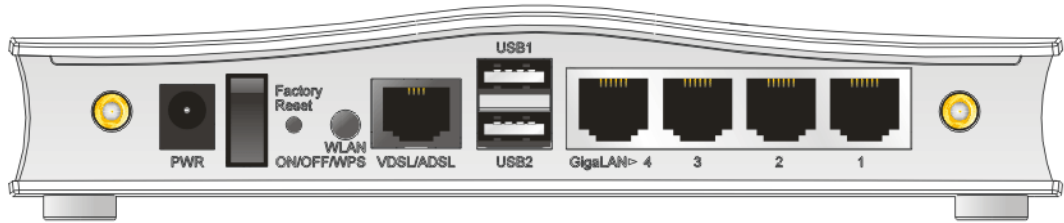

| Interface | Description |
|------------------------|---------------------------------------------------------------------------------------------------------------------------------------------------------------------------------------------------------------------------------------------------------------------------------------|
| PWR | Connector for a power adapter. |
| I / O | Power switch. |
| Factory Reset | Restore the default settings. Usage: Turn on the router (ACT LED is blinking). Press the hole and keep for more than 5 seconds. When you see the ACT LED begins to blink rapidly than usual, release the button. Then the router will restart with the factory default configuration. |
| WLAN ON/OFF/WPS | WLAN WPS - Press this button for 2 seconds to wait for client device making network connection through WPS. When the LED lights up, the WPS connection will be on. WLAN ON/OFF - Press the button once to enable (WLAN LED on) or disable (WLAN LED off) wireless connection. |
| VDSL/ADSL | RJ-11 connector for accessing the Internet (WAN1) |
| USB (1-2) | Connector for USB storage, printer or 3G/4G modem (WAN3) |
| LAN (1-4) (or WAN2) | RJ-45 (Gigabit Ethernet) connectors for local network devices. When WAN2 is enabled, LAN Port 4 becomes WAN2 (Ethernet) and WAN1 (RJ11) is disabled. |

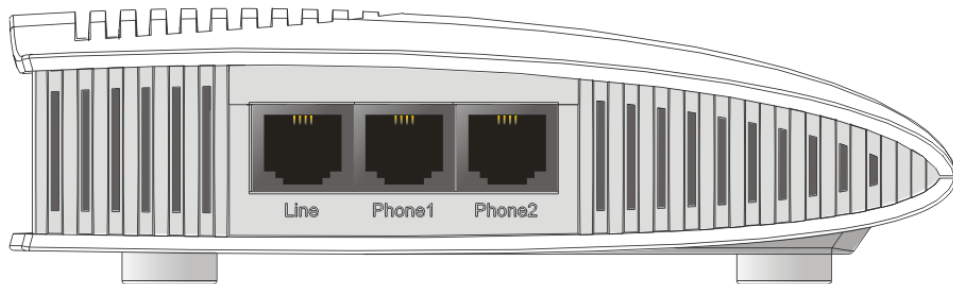

| Interface | Description |
|---------------|---------------------------------------------------|
| LINE | Connector for PSTN life line. |
| Phone1/Phone2 | Connector of analog phone for VoIP communication. |

1.4 Hardware Installation

Before starting to configure the router, you have to connect your devices correctly.

1. Connect the xDSL interface to the external XDSL splitter with an XDSL line cable for all models. For Vigor2760Vn, also connect Line interface to external XDSL splitter.

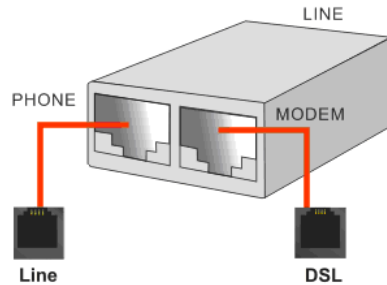

2. Connect one port of 4-port switch to your computer with a RJ-45 cable. This device allows you to connect 4 PCs directly.
3. Connect Phone port to a conventional analog telephone (for V model only).
4. Connect detachable antennas to the router for Vigor2760 series (for n model only).
5. Connect one end of the power cord to the power port of this device. Connect the other end to the wall outlet of electricity.
6. Power on the router.
7. Check the **ACT** and **DSL**, **LAN** LEDs to assure network connection.

(For the hardware connection, we take “n” model as an example.)

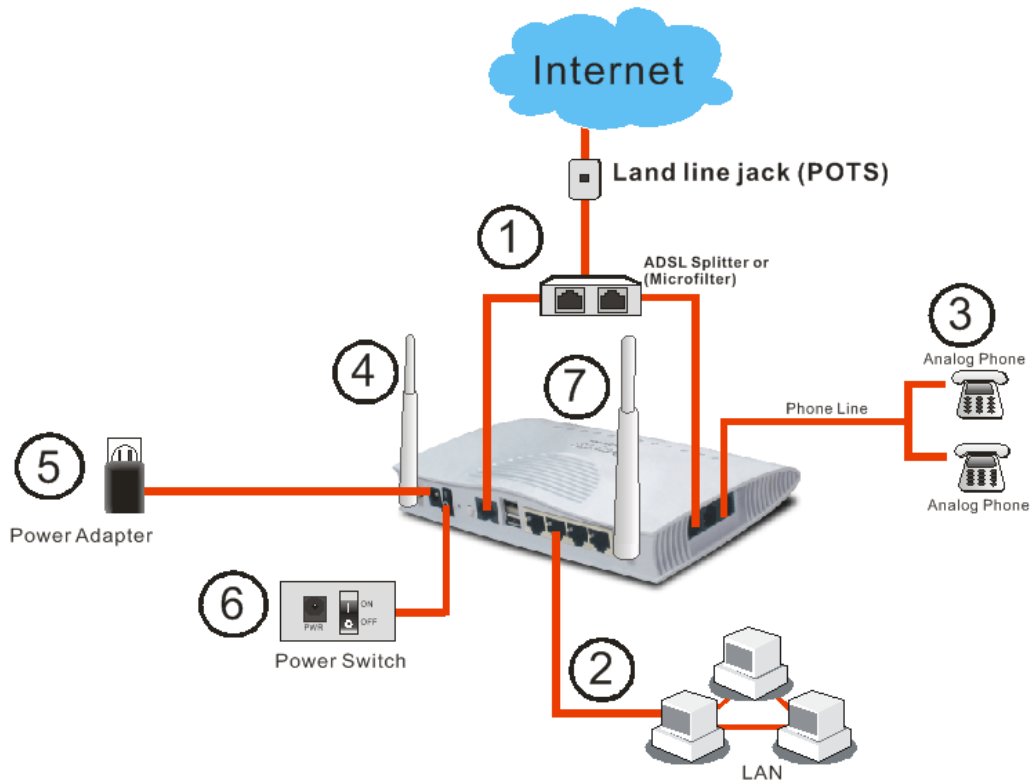

1.5 Printer Installation

You can install a printer onto the router for sharing printing. All the PCs connected this router can print documents via the router. The example provided here is made based on Windows XP. For other operating systems, please visit www.draytek.co.uk for the latest guides.

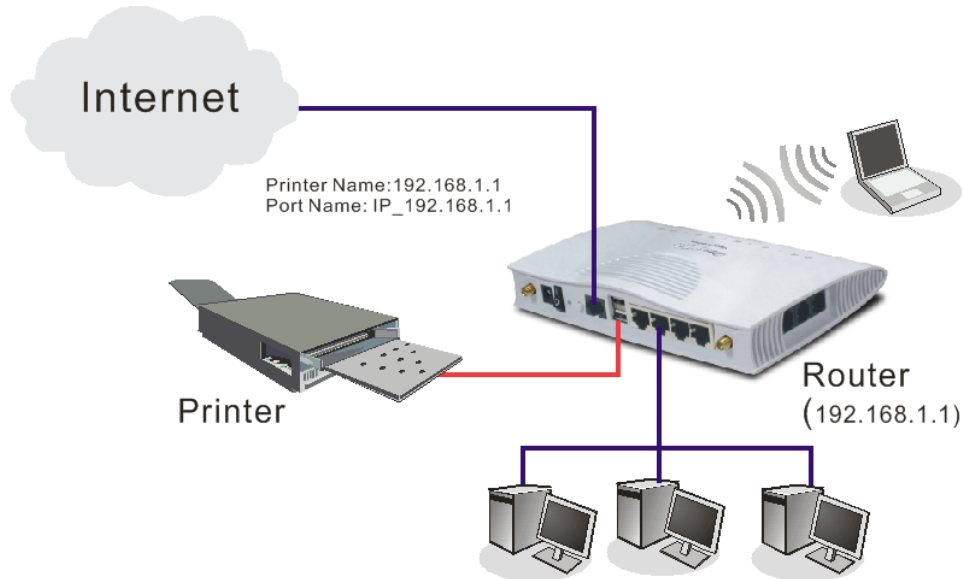

Before using it, please follow the steps below to configure settings for connected computers (or wireless clients).

1. Connect the printer with the router through USB/parallel port.
2. Open **All Programs>>Getting Started>>Devices and Printers**.

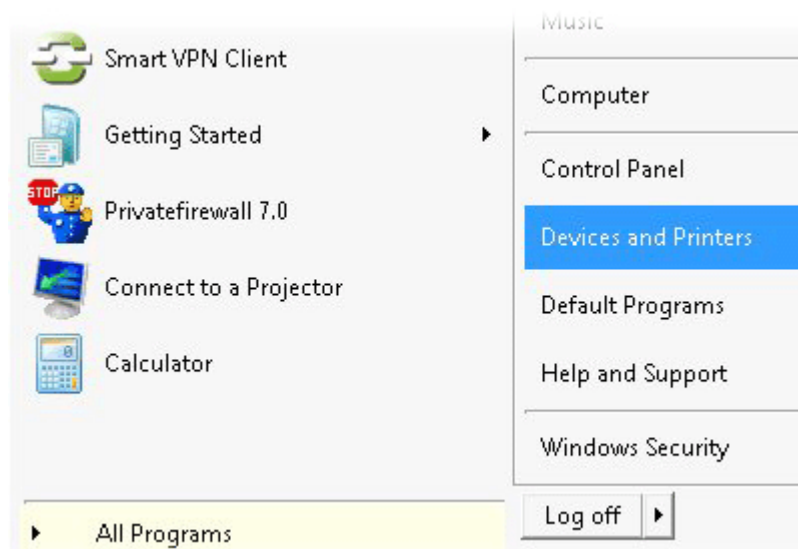

3. Click **Add a printer**.

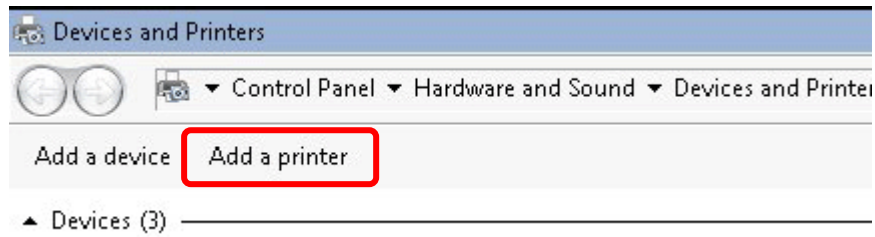

4. A dialog will appear. Click **Add a local printer** and click **Next**.

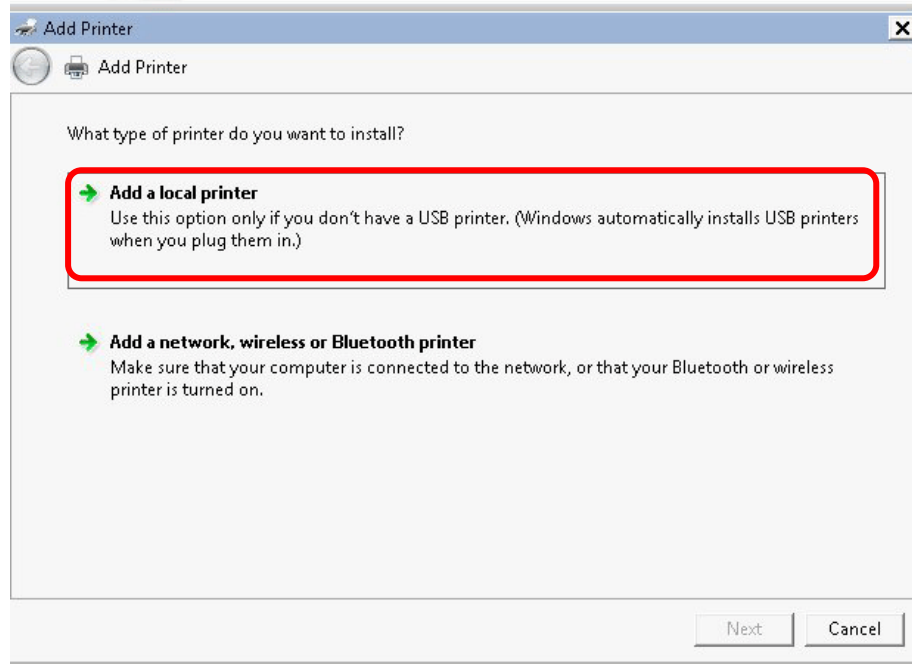

5. In this dialog, choose **Create a new port**. In the field of **Type of port**, use the drop down list to select **Standard TCP/IP Port**. Then, click **Next**.

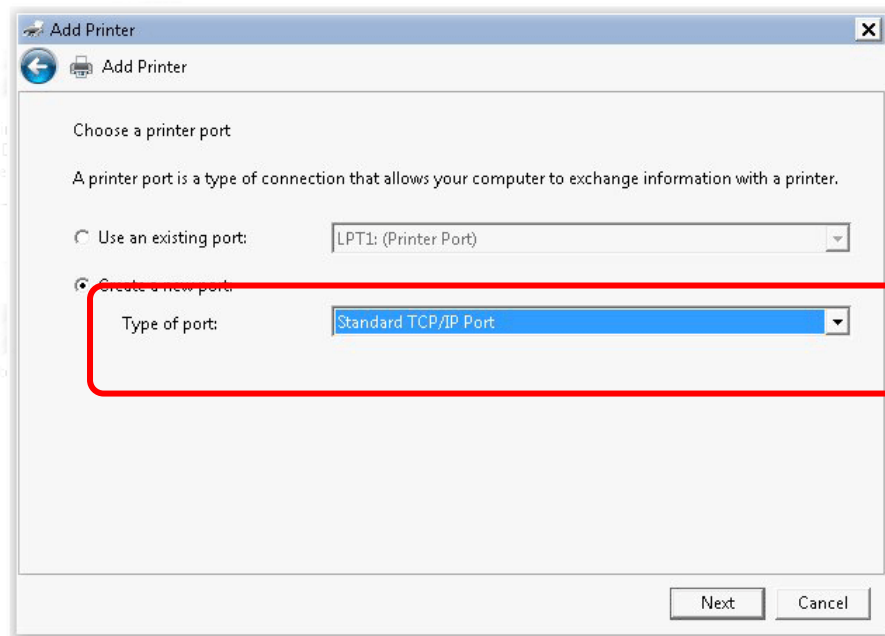

6. In the following dialog, type **192.168.1.1** (router's LAN IP) in the field of **Hostname or IP Address** and type **192.168.1.1** as the **Port name**. Then, click **Next**.

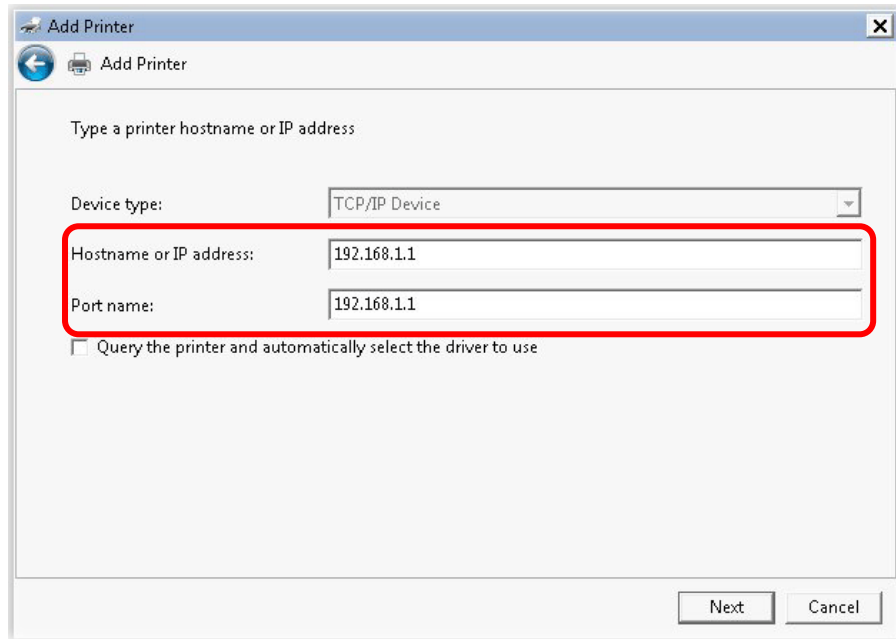

The screenshot shows the 'Add Printer' dialog box. The title bar says 'Add Printer'. Below the title bar, there is a back arrow icon and a printer icon with the text 'Add Printer'. The main area contains the text 'Type a printer hostname or IP address'. Below this, there is a 'Device type:' label and a dropdown menu showing 'TCP/IP Device'. Below that, there are two text input fields: 'Hostname or IP address:' and 'Port name:'. Both fields contain the text '192.168.1.1'. A red rectangular box highlights these two input fields. Below the input fields, there is a checkbox labeled 'Query the printer and automatically select the driver to use', which is currently unchecked. At the bottom right of the dialog, there are two buttons: 'Next' and 'Cancel'.

7. Click **Standard** and choose **Generic Network Card**.

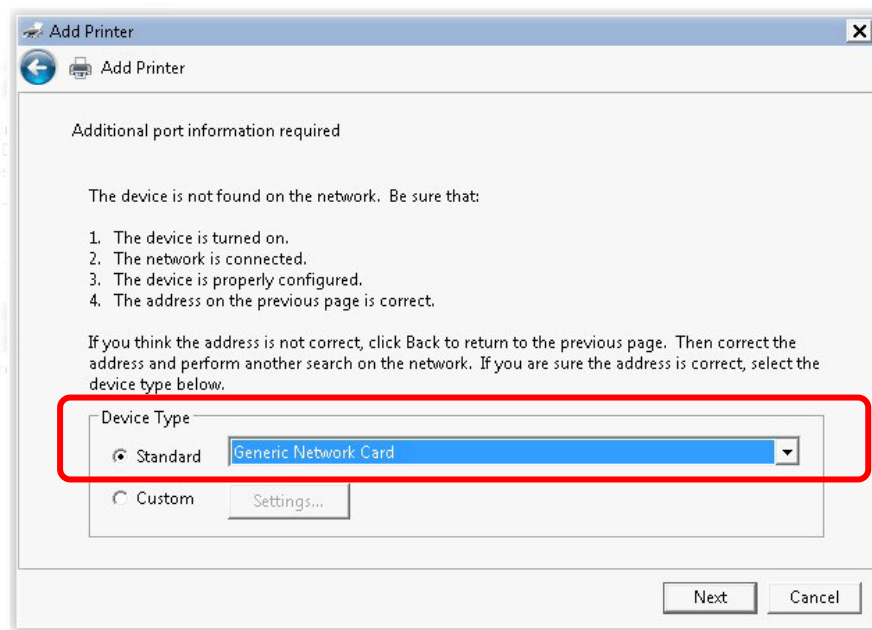

The screenshot shows the 'Add Printer' dialog box. The title bar says 'Add Printer'. Below the title bar, there is a back arrow icon and a printer icon with the text 'Add Printer'. The main area contains the text 'Additional port information required'. Below this, there is a paragraph: 'The device is not found on the network. Be sure that:'. Below the paragraph, there is a numbered list of four items: 1. The device is turned on. 2. The network is connected. 3. The device is properly configured. 4. The address on the previous page is correct. Below the list, there is a paragraph: 'If you think the address is not correct, click Back to return to the previous page. Then correct the address and perform another search on the network. If you are sure the address is correct, select the device type below.'. Below the paragraph, there is a 'Device Type' section. It has a radio button for 'Standard' which is selected, and a dropdown menu showing 'Generic Network Card'. A red rectangular box highlights the 'Standard' radio button and the 'Generic Network Card' dropdown. Below the 'Standard' radio button, there is a radio button for 'Custom' and a 'Settings...' button. At the bottom right of the dialog, there are two buttons: 'Next' and 'Cancel'.

8. Now, your system will ask you to choose right name of the printer that you installed onto the router. Such step can make correct driver loaded onto your PC. When you finish the selection, click **Next**.

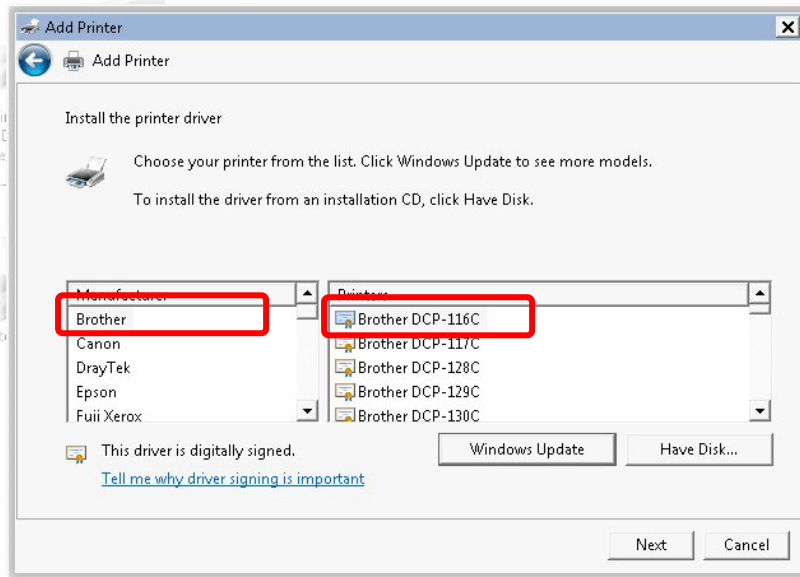

9. Type a name for the chosen printer. Click **Next**.

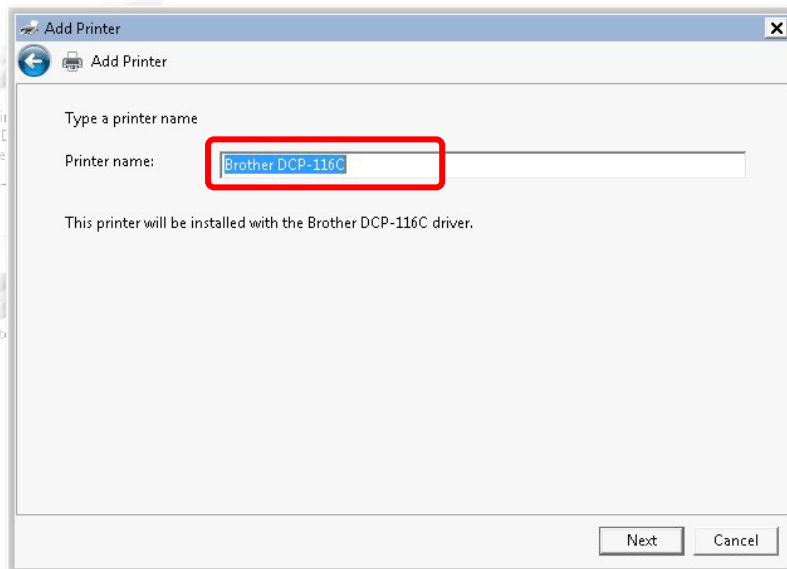

10. Choose **Do not share this printer** and click **Next**.

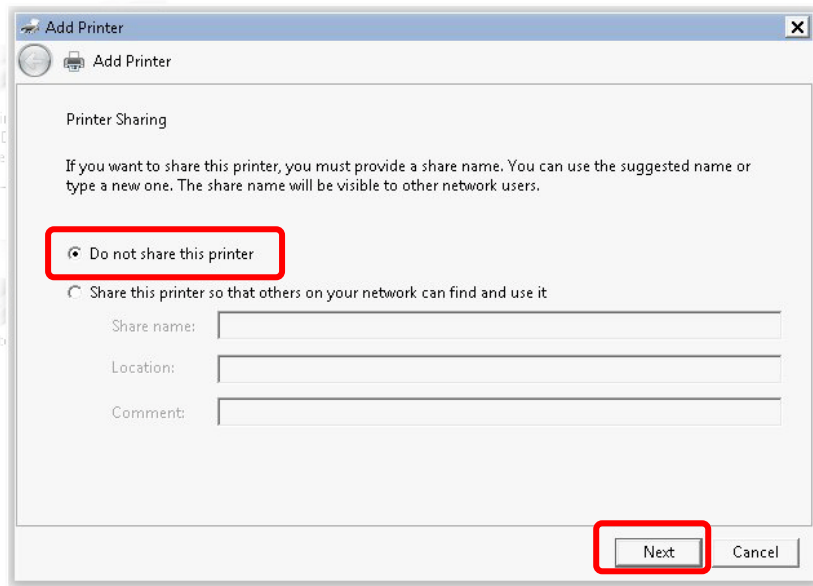

11. Then, in the following dialog, click **Finish**.

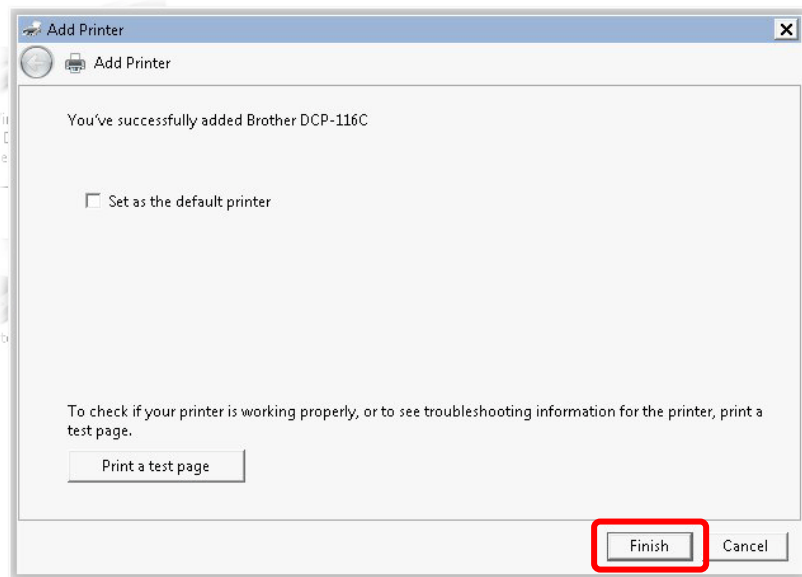

12. The new printer has been added and displayed under **Printers and Faxes**. Click the new printer icon and click **Printer server properties**.

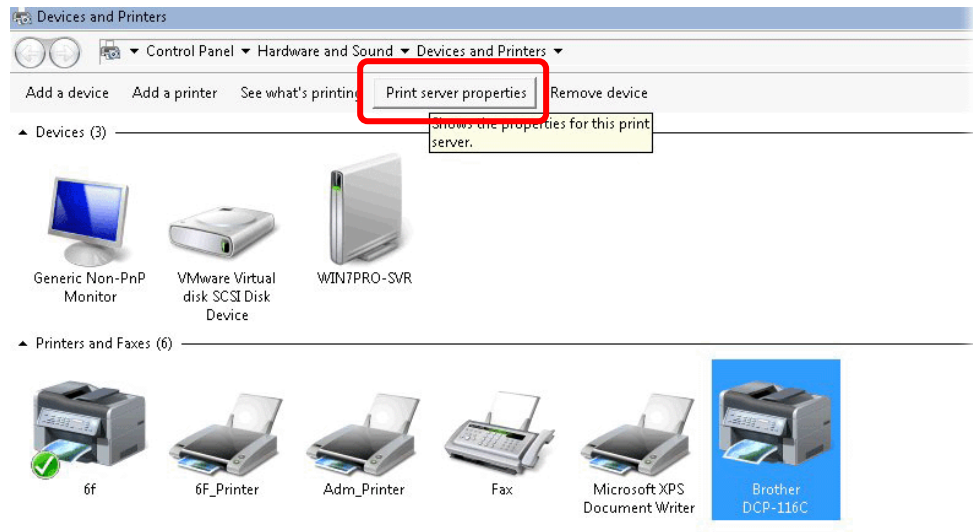

13. Edit the property of the new printer you have added by clicking **Configure Port**.

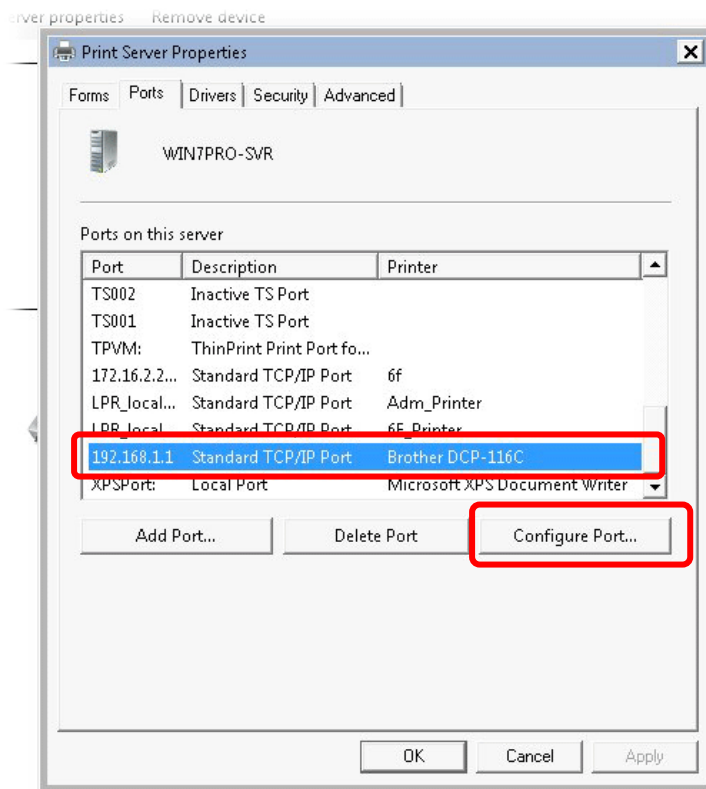

14. Select "**LPR**" on Protocol, type **p1** (number 1) as **Queue Name**. Then click **OK**. Next please refer to the red rectangle for choosing the correct protocol and LPR name.

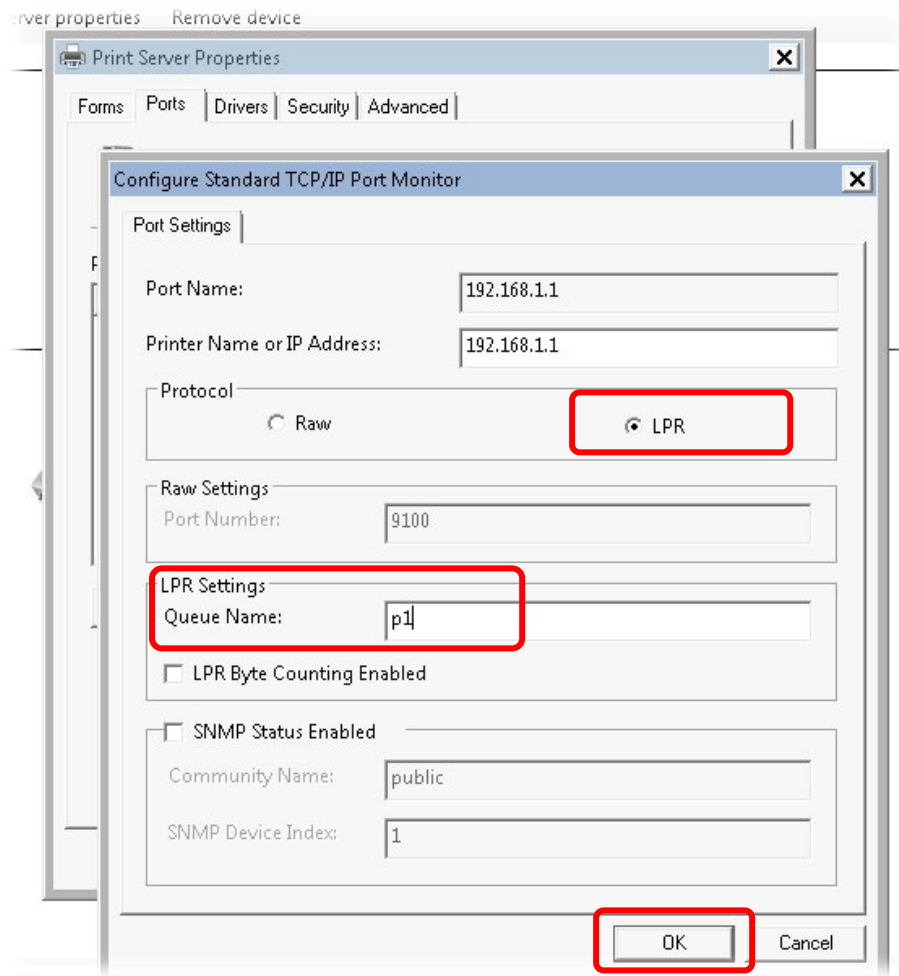

The printer can be used for printing now. Most of the printers with different manufacturers are compatible with vigor router.

Note 1: Some printers with the fax/scanning or other additional functions are not supported. If you do not know whether your printer is supported or not, please visit www.draytek.com to find out the printer list. Open **Support >FAQ/Application Notes**; find out the link of **USB>>Printer Server** and click it.

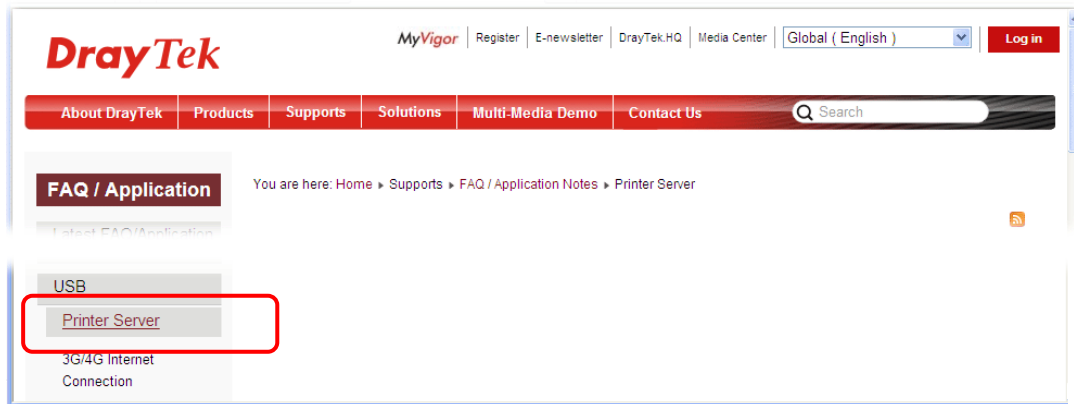

Then, click the **What types of printers are compatible with Vigor router?** link.

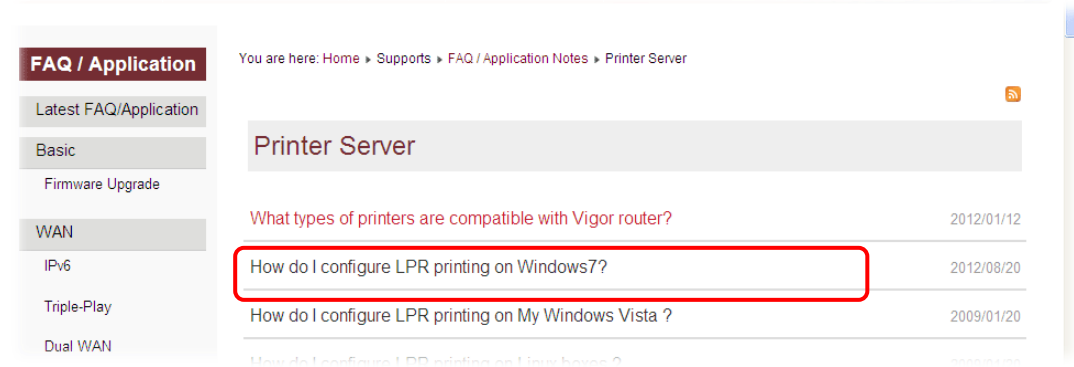

Note 2: Vigor router supports printing request from computers via LAN ports but not WAN port.

This page is left blank.

2

Quick Setup

2.1 Accessing Web Page

1. Make sure your PC connects to the router correctly.

You may either simply set up your computer to get IP dynamically from the router or set up the IP address of the computer to be the same subnet as **the default IP address of Vigor router 192.168.1.1**. For the detailed information, please refer to the later section - Trouble Shooting of the guide.

2. Open a web browser on your PC and type **http://192.168.1.1**. The following window will be open to ask for username and password.



DrayTek **Vigor2760 Series**

Login

Username

Password

Login

Copyright © 2013 DrayTek Corp. All Rights Reserved.

3. Please type “admin/admin” as the Username/Password and click **Login**.

Notice: If you fail to access to the web configuration, please go to “Trouble Shooting” for detecting and solving your problem.

- Now, the **Main Screen** will appear.

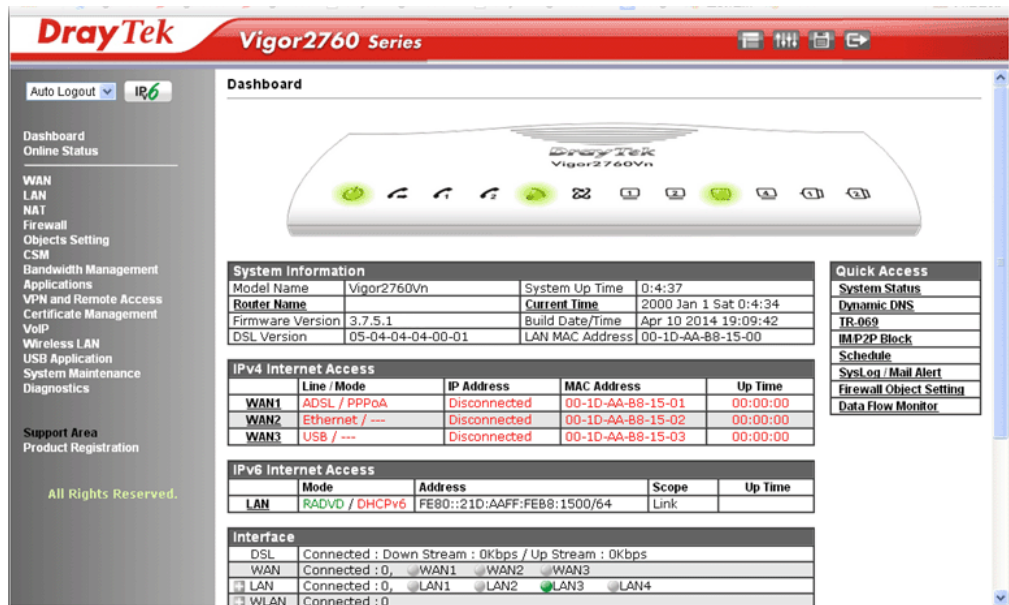

Note: The home page will be different slightly in accordance with the type of the router you have.

- The web page can be logged out according to the chosen condition. The default setting is **Auto Logout**, which means the web configuration system will logout after 5 minutes without any operation. Change the setting for your necessity.

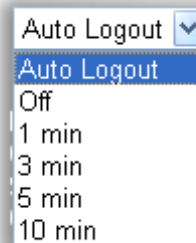

2.2 Changing Password

Please change the password for the original security of the router.

- Open a web browser on your PC and type **http://192.168.1.1**. A pop-up window will open to ask for username and password.
- Please type “admin/admin” as Username/Password for accessing into the web user interface with admin mode.
- Go to **System Maintenance** page and choose **Administrator Password**.

Administrator Password

| | | |
|------------------|----------------------|------------------------------|
| Old Password | <input type="text"/> | |
| New Password | <input type="text"/> | (Max. 23 characters allowed) |
| Confirm Password | <input type="text"/> | (Max. 23 characters allowed) |

Note: Password can contain only a-z A-Z 0-9 , ; : . " < > * + = \ | ? @ # ^ ! ()

4. Enter the login password (the default is “admin”) on the field of **Old Password**. Type **New Password** and **Confirm Password**. Then click **OK** to continue.

Note: The maximum length of the password you can set is 23 characters.

5. Now, the password has been changed. Next time, use the new password to access the Web user interface for this router.



The image shows the login page for the DrayTek Vigor2760 Series. At the top, there is a red banner with the DrayTek logo on the left and "Vigor2760 Series" on the right. Below the banner is a black bar with the word "Login" in white. The main content area is white and contains two input fields: "Username" with the text "admin" and "Password" with six dots. A "Login" button is positioned below the password field. At the bottom of the page, there is a copyright notice: "Copyright © 2013 DrayTek Corp. All Rights Reserved."

Note: Even the password is changed, the Username for logging onto the web user interface is still “admin”.

2.3 Introducing Dashboard

Dashboard shows the connection status including System Information, IPv4 Internet Access, IPv6 Internet Access, Interface (physical connection), Security and Quick Access.

Click **Dashboard** from the main menu on the left side of the main page.

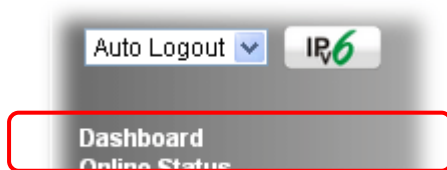

A web page with default selections will be displayed on the screen. Refer to the following figure:

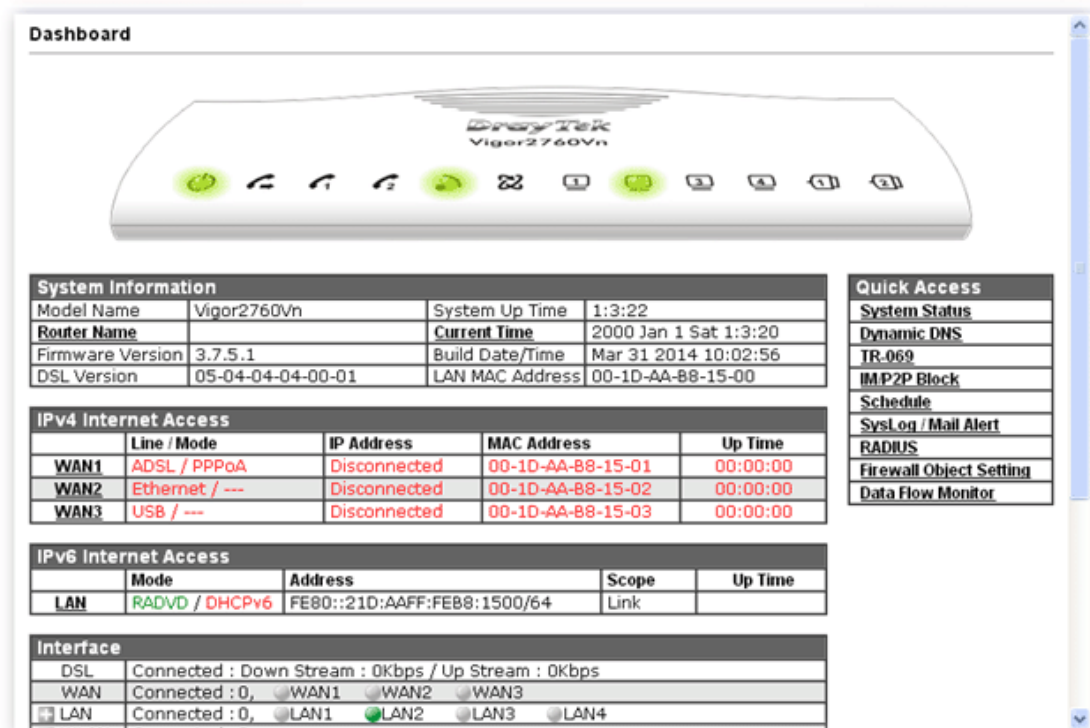

2.3.1 Virtual Panel

On the top of the Dashboard, a virtual panel (simulating the physical panel of the router) displays the physical interface connection. It will be refreshed every five seconds.



The LED lights or blinks according to the physical connection on the router. For detailed information about the LED display, refer to **1.2 LED Indicators and Connectors**.

2.3.2 Name with a Link

A name with a link (e.g., [Router Name](#), [Current Time](#), [WAN1](#) and etc.) below means you can click it to open the configuration page for modification.

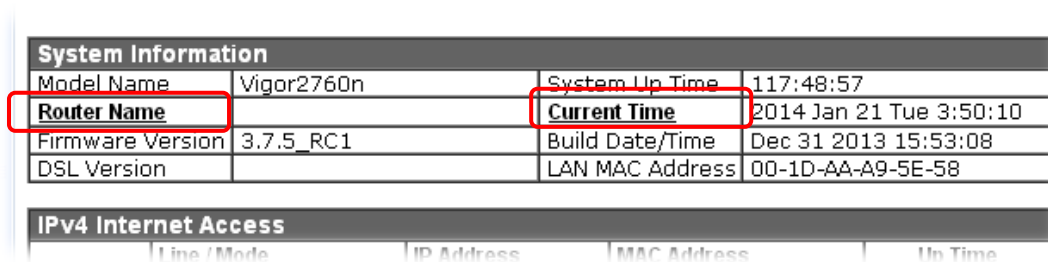

2.3.3 Quick Access for Common Used Menu

All the menu items can be accessed and arranged orderly on the left side of the main page for your request. However, some **important** and **common** used menu items which can be accessed in a quick way just for convenience.

Look at the right side of the Dashboard. You will find a group of common used functions grouped under **Quick Access**.

| Quick Access |
|-----------------------------------------|
| System Status |
| Dynamic DNS |
| TR-069 |
| IM/P2P Block |
| Schedule |
| SysLog / Mail Alert |
| Firewall Object Setting |
| Data Flow Monitor |

The function links of System Status, Dynamic DDNS, TR-069, IM/P2P Block, Schedule, Syslog/Mail Alert, RADIUS, Firewall Object Setting and Data Flow Monitor are displayed here. Move your mouse cursor on any one of the links and click on it. The corresponding setting page will be open immediately.

| Interface | |
|------------------------------------------|---------------------------------------------------------------------------------------------------------------------------------------|
| DSL | Connected : Down Stream : 0Kbps / Up Stream : 0Kbps |
| WAN | Connected : 1, <input type="radio"/> WAN1 <input checked="" type="radio"/> WAN2 <input type="radio"/> WAN3 |
| <input checked="" type="checkbox"/> LAN | Connected : 0, <input type="radio"/> LAN1 <input type="radio"/> LAN2 <input type="radio"/> LAN3 <input checked="" type="radio"/> LAN4 |
| <input checked="" type="checkbox"/> WLAN | Connected : 0 |
| USB | Connected : 0, <input type="radio"/> USB 1 0, <input type="radio"/> USB 2 |

Security

Note that there is a plus () icon located on the left side of VPN/LAN/WLAN. Click it to review the VPN/LAN/WLAN connection(s) used presently.

| Security | | | | |
|-----------------|-----------------|------------------------------------------------------------------------------|------------------------------------------------------------------|--|
| VPN | Connected : 1 | | Remote Dial-in User / LAN to LAN | |
| Current Page: 1 | | Page No. <input type="text" value="1"/> <input type="button" value="Go To"/> | | |
| Name / User | Type / Security | Host IP | Up Time | |
| V2920 | IPsec/3DES | 172.16.2.145 | 0:0:20 | |

User Mode is OFF now.

Host connected physically to the router via LAN port(s) will be displayed with green circles in the field of Connected.

All of the hosts (including wireless clients) displayed with Host ID, IP Address and MAC address indicates that the traffic would be transmitted through LAN port(s) and then the WAN port. The purpose is to perform the traffic monitor of the host(s).

2.3.4 GUI Map



All the functions the router supports are listed with table clearly in this page. Users can click the function link to access into the setting page of the function for detailed configuration. Click the icon on the top of the main screen to display all the functions.

GUI Map

| | | | |
|------------------------|-------------------------------------|-------------------------------|----------------------------------------|
| Dashboard | | VPN and Remote Access | Remote Access Control |
| Online Status | Physical Connection | | IPsec Peer Identity |
| | Virtual WAN | | LAN to LAN |
| WAN | General Setup | Certificate Management | Connection Management |
| | Internet Access | | Local Certificate |
| | Multi-PVC | | Trusted CA Certificate |
| LAN | General Setup | Wireless LAN | Certificate Backup |
| | VLAN | | General Setup |
| | Bind IP to MAC | | Security |
| | LAN Port Mirror | | Access Control |
| | Web Portal Setup | | WPS |
| NAT | Port Redirection | | WDS |
| | DMZ Host | | Advanced Setting |
| | Open Ports | | WMM Configuration |
| | Address Mapping | USB Application | AP Discovery |
| | Port Triggering | | Station List |
| Firewall | General Setup | | USB General Settings |
| | Filter Setup | | USB User Management |
| | DoS Defense | | File Explorer |
| Objects Setting | IP Object | System Maintenance | USB Device Status |
| | IP Group | | Modem Support List |
| | IPv6 Object | | System Status |
| | IPv6 Group | | TR-069 |
| | | | Administered Document |

2.3.5 Web Console



It is not necessary to use the telnet command via DOS prompt. The changes made by using web console have the same effects as modified through web user interface. The functions/settings modified under Web Console also can be reviewed on the web user interface.

Click the **Web Console** icon on the top of the main screen to open the following screen.



2.3.6 Config Backup



There is one way to store current used settings quickly by clicking the **Config Backup** icon. It allows you to backup current settings as a file. Such configuration file can be restored by using **System Maintenance>>Configuration Backup**.

Simply click the icon on the top of the main screen and a pop up dialog will appear.



Click **Save** to store the setting.

2.3.7 Logout



Click this icon to exit the web user interface.

2.4 Configuring WAN for Accessing Internet

For accessing Internet, you have to configure WAN settings including General Setup and Internet Access. Follow the steps below:

1. Open **WAN>>General Setup**.

WAN >> General Setup

| Index | Enable | Physical Mode/Type |
|----------------------|-------------------------------------|---------------------------|
| WAN1 | <input checked="" type="checkbox"/> | ADSL/- |
| WAN2 | <input type="checkbox"/> | Ethernet/Auto negotiation |
| WAN3 | <input checked="" type="checkbox"/> | USB/- |

Note: 1. WAN1 and WAN2 cannot work simultaneously, so when one of the interfaces is enabled, the other will be disabled. WAN3 can only serve as the backup WAN for WAN1 or WAN2, depending on which is active.
2. When WAN2 is enabled, LAN P4 port will be used as WAN2.

2. If the hardware connection for Vigor2760 is the same as shown in section 1.3 Hardware Installation, simply click **WAN1** link to open the following page.

WAN >> General Setup

| | |
|--------------------------------------|--------------------------------------------------------|
| WAN 1 | |
| Enable: | <input type="button" value="Yes"/> |
| Display Name: | <input type="text"/> |
| Physical Mode: | ADSL |
| DSL Mode: | <input type="button" value="Auto"/> |
| Physical Type: | <input type="button" value="Auto negotiation"/> |
| DSL Modem Code: | <input type="button" value="Default"/> |
| VLAN Tag insertion (ADSL): | <input type="button" value="Disable"/> (for channel 1) |
| Tag value: | <input type="text" value="0"/> (0~4095) |
| Priority: | <input type="text" value="0"/> (0~7) |
| VLAN Tag insertion (VDSL2): | <input type="button" value="Enable"/> |
| Tag value: | <input type="text" value="101"/> (0~4095) |
| Priority: | <input type="text" value="0"/> (0~7) |

3. Make sure WAN1 interface is enabled and click **OK** to exit.
4. Open **WAN>>Internet Access**.

WAN >> Internet Access

Internet Access

| Index | Display Name | Physical Mode | Access Mode | | |
|-------|--------------|---------------|---------------|------------------------------|----------------------|
| WAN1 | | ADSL / VDSL2 | PPPoE / PPPoA | Details Page | IPv6 |
| WAN2 | | Ethernet | None | Details Page | IPv6 |
| WAN3 | | USB | None | Details Page | IPv6 |

Note: Only one WAN can support IPv6.

[Advanced](#) You can configure DHCP client options here.

5. Click **Details Page** of WAN1. According to the information offered by your ISP, click **PPPoE/PPPoA**, **MPoA/Static or Dynamic** or **IPv6** tab to open the following page.

WAN >> Internet Access

WAN 1

| PPPoE / PPPoA | MPoA / Static or Dynamic IP | IPv6 |
|-----------------------------------------------------------------------|----------------------------------------------------------------------------|------|
| <input checked="" type="radio"/> Enable <input type="radio"/> Disable | | |
| Modem Settings (for ADSL only) | | |
| Multi-PVC channel | Channel 1 | |
| VPI | 0 | |
| VCI | 38 | |
| Encapsulating Type | VC MUX | |
| Protocol | PPPoA | |
| Modulation | Multimode | |
| PPPoE Pass-through | | |
| <input type="checkbox"/> For Wired LAN | | |
| <input type="checkbox"/> For Wireless LAN | | |
| WAN Connection Detection | | |
| Mode | ARP Detect | |
| Ping IP | | |
| TTL: | | |
| ISP Access Setup | | |
| Service Name (Optional) | | |
| Username | | |
| Password | | |
| <input type="checkbox"/> Separate Account for ADSL | | |
| PPP Authentication | PAP or CHAP | |
| Idle Timeout | -1 second(s) | |
| Fixed IP | <input type="radio"/> Yes <input checked="" type="radio"/> No (Dynamic IP) | |
| Fixed IP Address | | |
| <input checked="" type="radio"/> Default MAC Address | | |
| <input type="radio"/> Specify a MAC Address | | |
| MAC Address: | 00 · 1D · AA · BB · 15 · 01 | |
| Index(1-15) in Schedule Setup: | | |
| => [] , [] , [] , [] | | |

6. Fill in the required information offered by your ISP. Then click **OK** to save the settings
7. The router will restart to activate the settings configured here.
8. Now, you can surf the Internet whenever you want.

2.5 Online Status

Online Status
Physical Connection
Virtual WAN

2.5.1 Physical Connection

Such page displays the physical connection status such as LAN connection status, WAN connection status, ADSL information, and so on.

Physical Connection for IPv4 Protocol

Online Status

| Physical Connection | | | | | | System Uptime: 4days 23:49:27 |
|---------------------------------------------------|-----------|------------------------|--------------|------------------------|--------------|-------------------------------|
| IPv4 | | | IPv6 | | | |
| LAN Status | | Primary DNS: 10.39.0.1 | | Secondary DNS: 8.8.4.4 | | |
| IP Address | | TX Packets | | RX Packets | | |
| 192.168.1.1 | | 63074 | | 88053 | | |
| WAN 1 Status | | | | | | |
| Enable | Line | Name | Mode | Up Time | | |
| No | ADSL | | --- | 00:00:00 | | |
| IP | GW IP | TX Packets | TX Rate(Bps) | RX Packets | RX Rate(Bps) | |
| --- | --- | 0 | 0 | 0 | 0 | |
| WAN 2 Status >> Release | | | | | | |
| Enable | Line | Name | Mode | Up Time | | |
| Yes | Ethernet | | DHCP Client | 118:46:03 | | |
| IP | GW IP | TX Packets | TX Rate(Bps) | RX Packets | RX Rate(Bps) | |
| 10.39.0.13 | 10.39.0.1 | 44744 | 7264 | 25837 | 530 | |
| WAN 3 Status | | | | | | |
| Enable | Line | Name | Mode | Up Time | Signal | |
| Yes | USB | | --- | 00:00:00 | - | |
| IP | GW IP | TX Packets | TX Rate(Bps) | RX Packets | RX Rate(Bps) | |
| --- | --- | 0 | 0 | 0 | 0 | |
| ADSL Information (ADSL Firmware Version:) | | | | | | |
| ATM Statistics | | TX Cells | RX Cells | TX CRC errs | RX CRC errs | |
| | | 0 | 0 | 0 | 0 | |
| ADSL Status | Mode | State | Up Speed | Down Speed | SNR Margin | Loop Att. |
| | | | 0 | 0 | 0 | 0 |

Note: If the firmware which supports Vectoring has been installed to your Vigor router, you will see a short message of “with Vectoring support” near to VDSL2 Information. Such feature is available for VDSL2 only.

| | | | | | |
|----------------------------------------------------------------------------------------------|----------|--------------|---------------|--------------|----------------|
| --- | --- | 0 | 0 | 0 | 0 |
| WAN 3 Status | | | | | |
| Enable | Line | Name | Mode | Up Time | Signal |
| Yes | USB | | --- | 00:00:00 | - |
| IP | GW IP | TX Packets | TX Rate(Bps) | RX Packets | RX Rate(Bps) |
| --- | --- | 0 | 0 | 0 | 0 |
| VDSL2 Information (VDSL2 Firmware Version: 05-06-06-02-00-07 with Vectoring support) | | | | | |
| Profile | State | UP Speed | Down Speed | SNR Upstream | SNR Downstream |
| 30A | SHOWTIME | 93898 (Kbps) | 101058 (Kbps) | 6 (0.1dB) | 19 (0.1dB) |

Physical Connection for IPv6 Protocol

Online Status

| Physical Connection | | System Uptime: 4days 23:51:32 | |
|--------------------------------------------------------|--------------------------|-------------------------------|--------------------------|
| IPv4 | IPv6 | | |
| LAN Status | | | |
| IP Address FE80::21D:AFF:FEA9:5E58/64 (Link) | | | |
| TX Packets 1702 | RX Packets 200 | TX Bytes 134202 | RX Bytes 48922 |
| WAN IPv6 Status | | | |
| Enable No | Mode Offline | Up Time --- | Gateway IP --- |

Detailed explanation (for IPv4) is shown below:

| Item | Description |
|------------------------------|--------------------------------------------------------------------------------------------------------------------------------------------------------------------------------------------------------------------------------------------------------------------------------------------------------------------------------------------------------------------------------------------------------------------------------------------------------------------------------------------------------------------------------------------------------------------------------------------------------------------------------------------------------------------------------------------------------------------------------------------------------------------------------------------------------------------------------------------------------------------------------------------------------------------------------------------------------------------|
| LAN Status | <p>Primary DNS-Displays the primary DNS server address for WAN interface.</p> <p>Secondary DNS -Displays the secondary DNS server address for WAN interface.</p> <p>IP Address-Displays the IP address of the LAN interface.</p> <p>TX Packets-Displays the total transmitted packets at the LAN interface.</p> <p>RX Packets-Displays the total received packets at the LAN interface.</p> |
| WAN1/WAN2/WAN3 Status | <p>Enable – Yes in red means such interface is available but not enabled. Yes in green means such interface is enabled.</p> <p>Line – Displays the physical connection (VDSL, ADSL, Ethernet, or USB) of this interface.</p> <p>Name – Display the name of the router.</p> <p>Mode - Displays the type of WAN connection (e.g., PPPoE).</p> <p>Up Time - Displays the total uptime of the interface.</p> <p>IP - Displays the IP address of the WAN interface.</p> <p>GW IP - Displays the IP address of the default gateway.</p> <p>TX Packets - Displays the total transmitted packets at the WAN interface.</p> <p>TX Rate - Displays the speed of transmitted octets at the WAN interface.</p> <p>RX Packets - Displays the total number of received packets at the WAN interface.</p> <p>RX Rate - Displays the speed of received octets at the WAN interface.</p> |

Detailed explanation (for IPv6) is shown below:

| Item | Description |
|-------------------|----------------------------------------------------------|
| LAN Status | IP Address - Displays the IPv6 address of the LAN |

| Item | Description |
|------------------------|-------------------------------------------------------------------------------------------------------------------------------------------------------------------------------------------------------------------------------------------------------------------------------------------------------------------------------------------------------------------------------------------------------------------------------------------------------------------------|
| | interface.. TX Packets -Displays the total transmitted packets at the LAN interface. RX Packets -Displays the total received packets at the LAN interface. TX Bytes - Displays the speed of transmitted octets at the LAN interface. RX Bytes - Displays the speed of received octets at the LAN interface. |
| WAN IPv6 Status | Enable – No in red means such interface is available but not enabled. Yes in green means such interface is enabled. No in red means such interface is not available. Mode - Displays the type of WAN connection (e.g., TSPC). Up Time - Displays the total uptime of the interface. IP - Displays the IP address of the WAN interface. Gateway IP - Displays the IP address of the default gateway. |

Note: The words in green mean that the WAN connection of that interface is ready for accessing Internet; the words in red mean that the WAN connection of that interface is not ready for accessing Internet.

2.5.2 Virtual WAN

Such page displays the virtual WAN connection information.

Virtual WAN are used by TR-069 management, VoIP service and so on.

The field of Application will list the purpose of such WAN connection.

Online Status

| Virtual WAN | | | | | | System Uptime: 119:52:33 |
|---------------------|-------|------------|--------------|------------|--------------|--------------------------|
| WAN 4 Status | | | | | | |
| Enable | Line | Name | Mode | Up Time | Application | |
| Yes | ADSL | | --- | 00:00:00 | Management | |
| IP | GW IP | TX Packets | TX Rate(Bps) | RX Packets | RX Rate(Bps) | |
| --- | --- | 0 | 0 | 0 | 0 | |
| WAN 5 Status | | | | | | |
| Enable | Line | Name | Mode | Up Time | Application | |
| Yes | ADSL | | --- | 00:00:00 | Management | |
| IP | GW IP | TX Packets | TX Rate(Bps) | RX Packets | RX Rate(Bps) | |
| --- | --- | 0 | 0 | 0 | 0 | |
| WAN 6 Status | | | | | | |
| Enable | Line | Name | Mode | Up Time | Application | |
| Yes | ADSL | | --- | 00:00:00 | Management | |
| IP | GW IP | TX Packets | TX Rate(Bps) | RX Packets | RX Rate(Bps) | |
| --- | --- | 0 | 0 | 0 | 0 | |

2.6 Saving Configuration

Each time you click **OK** on the web page for saving the configuration, you can find messages showing the system interaction with you.



Admin mode
Status: Settings Saved

Ready indicates the system is ready for you to input settings.

Settings Saved means your settings are saved once you click **Finish** or **OK** button.

This page is left blank.

3

Advanced Configuration

This chapter will guide users to execute web configuration.

1. Open a web browser on your PC and type **http://192.168.1.1**. The window will ask for typing username and password.
2. Please type “admin/admin” on Username/Password for administration operation.

Now, the **Main Screen** will appear. Note that different model will have different web pages.

The screenshot displays the DrayTek web management interface for the Vigor2760 Series. The main content area includes:

- System Information:**

| | | | |
|------------------|-------------------|-----------------|-----------------------|
| Model Name | Vigor2760Vn | System Up Time | 0:4:37 |
| Router Name | | Current Time | 2000 Jan 1 Sat 0:4:34 |
| Firmware Version | 3.7.5.1_RC1 | Build Date/Time | Apr 10 2014 19:09:42 |
| DSL Version | 05-04-04-04-00-01 | LAN MAC Address | 00-1D-AA-B8-15-00 |
- IP4 Internet Access:**

| | Line / Mode | IP Address | MAC Address | Up Time |
|------|----------------|--------------|-------------------|----------|
| WAN1 | ADSL / PPPoA | Disconnected | 00-1D-AA-B8-15-01 | 00:00:00 |
| WAN2 | Ethernet / --- | Disconnected | 00-1D-AA-B8-15-02 | 00:00:00 |
| WAN3 | USB / --- | Disconnected | 00-1D-AA-B8-15-03 | 00:00:00 |
- IPv6 Internet Access:**

| | Mode | Address | Scope | Up Time |
|-----|----------------|----------------------------|-------|---------|
| LAN | RADVD / DHCPv6 | FE80::21D:AFF:FE88:1500/64 | Link | |
- Interface:**

| | |
|------|-----------------------------------------------------|
| DSL | Connected : Down Stream : 0Kbps / Up Stream : 0Kbps |
| WAN | Connected : 0, WAN1, WAN2, WAN3 |
| LAN | Connected : 0, LAN1, LAN2, LAN3, LAN4 |
| WLAN | Connected : 0 |

3.1 WAN

Quick Start Wizard offers user an easy method to quick setup the connection mode for the router. Moreover, if you want to adjust more settings for different WAN modes, please go to WAN group.

3.1.1 Basics of Internet Protocol (IP) Network

IP means Internet Protocol. Every device in an IP-based Network including routers, print server, and host PCs, needs an IP address to identify its location on the network. To avoid address conflicts, IP addresses are publicly registered with the Network Information Centre (NIC). Having a unique IP address is mandatory for those devices participated in the public network but not in the private TCP/IP local area networks (LANs), such as host PCs under the management of a router since they do not need to be accessed by the public. Hence, the NIC has reserved certain addresses that will never be registered publicly. These are known as *private* IP addresses, and are listed in the following ranges:

From 10.0.0.0 to 10.255.255.255

From 172.16.0.0 to 172.31.255.255

From 192.168.0.0 to 192.168.255.255

What are Public IP Address and Private IP Address

As the router plays a role to manage and further protect its LAN, it interconnects groups of host PCs. Each of them has a private IP address assigned by the built-in DHCP server of the Vigor router. The router itself will also use the default **private IP** address: 192.168.1.1 to communicate with the local hosts. Meanwhile, Vigor router will communicate with other network devices through a **public IP** address. When the data flow passing through, the Network Address Translation (NAT) function of the router will dedicate to translate public/private addresses, and the packets will be delivered to the correct host PC in the local area network. Thus, all the host PCs can share a common Internet connection.

Get Your Public IP Address from ISP

In ADSL deployment, the PPP (Point to Point)-style authentication and authorization is required for bridging customer premises equipment (CPE). Point to Point Protocol over Ethernet (PPPoE) connects a network of hosts via an access device to a remote access concentrator or aggregation concentrator. This implementation provides users with significant ease of use. Meanwhile it provides access control, billing, and type of service according to user requirement.

When a router begins to connect to your ISP, a series of discovery process will occur to ask for a connection. Then a session will be created. Your user ID and password is authenticated via **PAP** or **CHAP** with **RADIUS** authentication system. And your IP address, DNS server, and other related information will usually be assigned by your ISP.

Network Connection by 3G/4G USB Modem

By connecting an optional 3G/4G (LTE) USB Modem, the Vigor 2760 can support cellular network connections. Vigor2760n with 3G USB Modem allows you to receive 3G signals at any place such as your car or certain location holding outdoor activity and share the bandwidth for using by more people. Users can use four LAN ports on the router to access Internet. Also, they can access Internet via 802.11n wireless function of Vigor2760n, and enjoy the powerful firewall, bandwidth management, VPN features of Vigor2760n series.



After connecting into the router, 3G USB Modem will be regarded as the third WAN port. However, the original WAN1 and WAN2 still can be used and Load-Balance can be done in the router. Besides, 3G USB Modem in WAN3 also can be used as backup device. Therefore, when WAN1 and WAN2 are not available, the router will use 3.5G for supporting automatically. The supported 3G USB Modem will be listed at www.draytek.co.uk

Below shows the menu items for **WAN**.

3.1.2 General Setup

This section will introduce some general settings of Internet and explain the connection modes for WAN1, WAN2 and WAN3 in details.

This router supports multiple-WAN function. It allows users to access Internet and combine the bandwidth of the multiple WANs to speed up the transmission through the network. Each WAN port can connect to different ISPs, Even if the ISPs use different technology to provide telecommunication service (such as DSL, Cable modem, etc.). If any connection problem occurred on one of the ISP connections, all the traffic will be guided and switched to the normal communication port for proper operation. Please configure WAN1, WAN2, and WAN3 settings.

This webpage allows you to set general setup for WAN1, WAN2, and WAN3 respectively. In default, WAN2 is disabled. If you want to enable it, simply click the WAN2 link and select **Yes** in the field of **Enable**.

WAN >> General Setup

| Setup | | |
|----------------------|--------|---------------------------|
| Index | Enable | Physical Mode/Type |
| WAN1 | - | ADSL/- |
| WAN2 | √ | Ethernet/Auto negotiation |
| WAN3 | √ | USB/- |

Note: WAN1 and WAN2 cannot work simultaneously, so when one of the interfaces is enabled, the other will be disabled. WAN3 can only serve as the backup WAN for WAN1 or WAN2, depending on which is active.

OK

Available settings are explained as follows:

| Item | Description |
|-----------------------------|-------------------------------------------------------------------------------------|
| Index | Click the WAN interface link under Index to access into the WAN configuration page. |
| Enable | √ means such WAN interface is enabled and ready to be used. |
| Physical Mode / Type | Display the physical mode and physical type of such WAN interface. |

Note: In default, each WAN port is enabled.

After finished the above settings, click **OK** to save the settings.

WAN1 with ADSL/VDSL

Vigor router will **detect** the physical line is connected by ADSL or VDSL2 **automatically**. Therefore, this page allows you to configure settings for ADSL and VDSL2 at one time. That is, it is not necessary for you to configure different profile settings for ADSL and VDSL2 respectively.

WAN >> General Setup

WAN 1

| | |
|--------------------------------------|----------------------------------------------------------|
| Enable: | Yes <input type="button" value="v"/> |
| Display Name: | <input type="text"/> |
| Physical Mode: | ADSL |
| DSL Mode: | Auto <input type="button" value="v"/> |
| Physical Type: | Auto negotiation <input type="button" value="v"/> |
| DSL Modem Code: | Default <input type="button" value="v"/> |
| VLAN Tag insertion (ADSL): | Disable <input type="button" value="v"/> (for channel 1) |
| Tag value: | <input type="text" value="0"/> (0~4095) |
| Priority: | <input type="text" value="0"/> (0~7) |
| VLAN Tag insertion (VDSL2): | Enable <input type="button" value="v"/> |
| Tag value: | <input type="text" value="101"/> (0~4095) |
| Priority: | <input type="text" value="0"/> (0~7) |

Note:

1. WAN1 and WAN2 cannot work simultaneously, so when one of the interfaces is enabled, the other will be disabled. WAN3 can only serve as the backup WAN for WAN1 or WAN2, depending on which is active.
2. In DSL auto mode, the router will reboot automatically while switching between VDSL2 and ADSL lines.

Available settings are explained as follows:

| Item | Description |
|-----------------------|--------------------------------------------------------------------------------------------------------------------------------------------------------------------------------------------------------------------------------------------------------------------------------------------------------------------------------------------------------------------------------------------------------------------------------------------|
| Enable | Choose Yes to invoke the settings for this WAN interface. Choose No to disable the settings for this WAN interface. |
| Display Name | Type the description for such interface. |
| Physical Mode | Display the physical mode of such interface. If VDSL2 is detected, this field will display “ VDSL2 ”; if ADSL is detected, it will display “ ADSL ”. |
| DSL Mode | Specify the physical mode (VDSL or ADSL) for such router manually. |
| Physical Type | For such interface, no type can be selected. |
| DSL Modem Code | Choose the correct DSL modem code for ensuring the network connection. <div style="border: 1px solid gray; padding: 5px; width: fit-content; margin: 5px auto;"> <input type="button" value="Default"/> <input type="button" value="v"/> Default AnnexA_560816_552011 AnnexA_548006_544401 </div> <p>If you have no idea about the selection, simply choose Default or contact the dealer for assistance.</p> |

| | |
|-----------------------------------|-----------------------------------------------------------------------------------------------------------------------------------------------------------------------------------------------------------------------------------------------------------------------------------------------------------------------------------------------------------------------------------------------------------------------------------------------------------------------------------------------------------------------------------------------------------------------------------------|
| VLAN Tag insertion (ADSL) | <p>The settings configured in this field are available for ADSL.</p> <p>Enable – Enable the function of VLAN with tag. The router will add specific VLAN number to all packets on the WAN while sending them out. Please type the tag value and specify the priority for the packets sending by WAN1.</p> <p>Disable – Disable the function of VLAN with tag.</p> <p>Tag value – Type the value as the VLAN ID number. The range is form 0 to 4095.</p> <p>Priority – Type the packet priority number for such VLAN. The range is from 0 to 7.</p> |
| VLAN Tag insertion (VDSL2) | <p>The settings configured in this field are available for VDSL2.</p> <p>Enable – Enable the function of VLAN with tag. The router will add specific VLAN number to all packets on the WAN while sending them out. Please type the tag value and specify the priority for the packets sending by WAN1.</p> <p>Disable – Disable the function of VLAN with tag.</p> <p>Tag value – Type the value as the VLAN ID number. The range is form 0 to 4095.</p> <p>Priority – Type the packet priority number for such VLAN. The range is from 0 to 7.</p> |

After finished the above settings, click **OK** to save the settings.

WAN2 with Ethernet

The physical LAN4 port can be treated as a WAN interface, named WAN2.

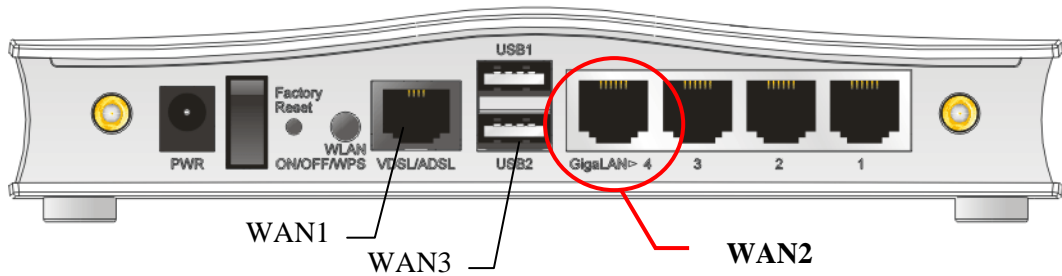

When WAN2 is enabled, WAN1 (DSL) will be disabled automatically.

WAN >> General Setup

WAN 2

| | |
|----------------------|-------------------------------------------------------------------------------------------|
| Enable: | Yes <input type="button" value="v"/> |
| Display Name: | <input type="text"/> |
| Physical Mode: | Ethernet |
| Physical Type: | Auto negotiation <input type="button" value="v"/> |
| VLAN Tag insertion : | Disable <input type="button" value="v"/> (Please configure Internet Access setting first) |
| Tag value: | <input type="text" value="0"/> (0~4095) |
| Priority: | <input type="text" value="0"/> (0~7) |

Note:

1. WAN1 and WAN2 cannot work simultaneously, so when one of the interfaces is enabled, the other will be disabled. WAN3 can only serve as the backup WAN for WAN1 or WAN2, depending on which is active.
2. When WAN2 is enabled, LAN P4 port will be used as WAN2.

Available settings are explained as follows:

| Item | Description |
|---------------------------|--------------------------------------------------------------------------------------------------------------------------------------------------------------------------------------------------|
| Enable | Choose Yes to invoke the settings for this WAN interface. Choose No to disable the settings for this WAN interface. |
| Display Name | Type the description for such WAN interface. |
| Physical Mode | Display the physical mode of such WAN interface. |
| Physical Type | You can change the physical type for WAN2 or choose Auto negotiation for determined by the system.  |
| VLAN Tag insertion | Enable – Enable the function of VLAN with tag. The router will add specific VLAN number to all packets on |

the WAN while sending them out.
 Please type the tag value and specify the priority for the packets sending by WAN1.
Disable – Disable the function of VLAN with tag.
Tag value – Type the value as the VLAN ID number. The range is form 0 to 4095.
Priority – Type the packet priority number for such VLAN. The range is from 0 to 7.

After finished the above settings, click **OK** to save the settings.

WAN3 with USB

To use 3G/4G network connection through 3G/4G USB Modem, please configure **WAN3** interface.

WAN >> General Setup

WAN 3

| | |
|----------------|------------------------------------|
| Enable: | <input type="button" value="Yes"/> |
| Display Name: | <input type="text"/> |
| Physical Mode: | USB |

Note:

WAN1 and WAN2 cannot work simultaneously, so when one of the interfaces is enabled, the other will be disabled. WAN3 can only serve as the backup WAN for WAN1 or WAN2, depending on which is active.

Available settings are explained as follows:

| Item | Description |
|----------------------|-----------------------------------------------------------------------------------------------------------------------------------|
| Enable | Choose Yes to invoke the settings for this WAN interface. Choose No to disable the settings for this WAN interface. |
| Display Name | Type the description for such WAN interface. |
| Physical Mode | Display the physical mode of such WAN interface. |

After finished the above settings, click **OK** to save the settings.

3.1.3 Internet Access

For the router supports multi-WAN function, the users can set different WAN settings (for WAN1/WAN2/WAN3) for Internet Access.

Understand your WAN Ports: WAN1 is the RJ11 port supporting ADSL or VDSL. WAN2 is Ethernet switchable with LAN4 and WAN3 is the USB port using an optional 3G/4G modem. You cannot enable WAN1 and WAN2 at the same time.

Due to different Physical Mode for WAN interface, the Access Mode for these connections also varies. Refer to the following figures.

WAN >> Internet Access

Internet Access

| Index | Display Name | Physical Mode | Access Mode | | |
|-------|--------------|---------------|------------------------------------------------------|--------------|------|
| WAN1 | | ADSL / VDSL2 | None | Details Page | IPv6 |
| WAN2 | | Ethernet | None PPPoE / PPPoA MPoA / Static or Dynamic IP | Details Page | IPv6 |
| WAN3 | | USB | None | Details Page | IPv6 |

Note: Only one WAN can support IPv6.

[Advanced](#) You can configure DHCP client options here.

WAN >> Internet Access

Internet Access

| Index | Display Name | Physical Mode | Access Mode | | |
|-------|--------------|---------------|-----------------------------------------------|--------------|------|
| WAN1 | | ADSL / VDSL2 | None | Details Page | IPv6 |
| WAN2 | | Ethernet | Static or Dynamic IP | Details Page | IPv6 |
| WAN3 | | USB | None PPPoE Static or Dynamic IP PPTP | Details Page | IPv6 |

Note: Only one WAN can support IPv6.

[Advanced](#) You can configure DHCP client options here.

WAN >> Internet Access

Internet Access

| Index | Display Name | Physical Mode | Access Mode | | |
|-------|--------------|---------------|----------------------------------------------------------------------|--------------|------|
| WAN1 | | ADSL / VDSL2 | None | Details Page | IPv6 |
| WAN2 | | Ethernet | Static or Dynamic IP | Details Page | IPv6 |
| WAN3 | | USB | None None 3G/4G USB Modem(PPP mode) 4G USB Modem(DHCP mode) | Details Page | IPv6 |

Note: Only one WAN can support IPv6.

[Advanced](#) You can configure DHCP client options here.

Available settings are explained as follows:

| Item | Description |
|---------------------|------------------------------------------------------------------------|
| Index | Display the WAN interface. |
| Display Name | It shows the name of the WAN1/WAN2/WAN3 that entered in general setup. |

| Physical Mode | It shows the physical connection for WAN1(ADSL/VDSL2) / WAN2 (Ethernet) /WAN3 (3G/4G USB Modem) according to the real network connection. | | | | | | | | | | |
|--------------------------|-----------------------------------------------------------------------------------------------------------------------------------------------------------------------------------------------------------------------------------------------------------------------------------------------------------------------------------------------------------------------------------------------------------------------------------------------------------------------------------------------------------------------------------------------------------------------------------------------------------------------------------------------------------------------------------------------------------------------------------------------------------------------------------------------------------------------------------------------------------------------------------------------------------------------------------------------------------------------------------------------------------------------------------------------------------------------------------------------------------------------------------------------------------------------------------------------------------------------------------------------------------------------------------------------------------------------------------------------------------------------------------------------------------------------------------------------------------------------------------------------------------------------------------------------------------------------------------------------------------------------------------------------------------------------------------------------------------------------------------------------------------------------------------------------------------------------------------------------------------------------------------------------------------------------------------------------------------------------------------------------------------------------------------------------------------------------------------------------------------------------------------------------------------------------------------------------------------------------------------------------------------------------------------------------------------------------------------------------------------------------------------------------------------------------------------------------------------------------------------------------------------------------------------------------------------|--------|-----------|--------|------|------|--------------------------|--|--|--|--|
| Access Mode | Use the drop down list to choose a proper access mode. The details page of that mode will be popped up. If not, click Details Page for accessing the page to configure the settings. | | | | | | | | | | |
| Details Page | This button will open different web page (based on IPv4) according to the access mode that you choose in WAN interface. Note that Details Page will be changed slightly based on ADSL/VDSL2 physical mode specified on WAN>>General Setup . | | | | | | | | | | |
| IPv6 | This button will open different web page (based on Physical Mode) to setup IPv6 Internet Access Mode for WAN interface. If IPv6 service is active on this WAN interface, the color of “IPv6” will become green. | | | | | | | | | | |
| Advanced | <p>This button allows you to configure DHCP client options. DHCP packets can be processed by adding option number and data information when such function is enabled and configured.</p> <p>WAN >> Internet Access</p> <hr/> <p>DHCP Client Options Status</p> <div data-bbox="708 1137 1394 1464" style="border: 1px solid black; padding: 5px;"> <p>Options List</p> <table border="1"> <thead> <tr> <th>Enable</th> <th>Interface</th> <th>Option</th> <th>Type</th> <th>Data</th> </tr> </thead> <tbody> <tr> <td style="text-align: center;"><input type="checkbox"/></td> <td></td> <td></td> <td></td> <td></td> </tr> </tbody> </table> <p>Enable: <input checked="" type="checkbox"/></p> <p>Interface: <input type="checkbox"/> All <input checked="" type="checkbox"/> WAN1 <input type="checkbox"/> WAN2 <input type="checkbox"/> WAN3 <input type="checkbox"/> WAN4 <input type="checkbox"/> WAN5 <input type="checkbox"/> WAN6</p> <p>Option Number: <input type="text"/></p> <p>Data Type: <input checked="" type="radio"/> ASCII Character (EX: Option:18, Data:/path) <input type="radio"/> Hexadecimal Digit (EX: Option:18, Data:2f70617468) <input type="radio"/> Address List (EX: Option:44, Data:172.16.2.10,172.16.2.20...)</p> <p>Data: <input type="text"/></p> <p style="text-align: right;"><input type="button" value="Add"/> <input type="button" value="Update"/> <input type="button" value="Delete"/></p> </div> <p><small>Note: Option 61 has been given a default value. You can configure option 61(Client Identifier) in "WAN >> Internet Access" page. If you choose to configure option 61 here, the settings in "WAN >> Internet Access, Details Page" will be overwritten. Option 12 is reserved, you cannot configure it here but you can configure it in "Router Name" field of "WAN >> Internet Access".</small></p> <p style="text-align: center;"><input type="button" value="OK"/></p> <p>Enable/Disable – Enable/Disable the function of DHCP Option. Each DHCP option is composed by an option number with data. For example, Option number: 100 Data: abcd</p> <p>When such function is enabled, the specified values for DHCP option will be seen in DHCP reply packets.</p> <p>Interface – Specify the WAN interface(s) that will be overwritten by such function. WAN4 ~ WAN6 can be located under WAN>>Multi-PVC.</p> <p>Option Number – Type a number for such function.</p> | Enable | Interface | Option | Type | Data | <input type="checkbox"/> | | | | |
| Enable | Interface | Option | Type | Data | | | | | | | |
| <input type="checkbox"/> | | | | | | | | | | | |

Note: If you choose to configure option 61 here, the detailed settings in WAN>>Interface Access will be overwritten.

Data Type – Choose the type (ASCII or Hex) for the data to be stored.

Data – Type the content of the data to be processed by the function of DHCP option.

Details Page for PPPoE in WAN1 (Physical Mode: VDSL2)

To choose PPPoE as the accessing protocol of the Internet, please select **PPPoE** from the **WAN>>Internet Access >>WAN1** page. The following web page will be shown.

WAN >> Internet Access

Available settings are explained as follows:

| Item | Description |
|---------------------------------|--------------------------------------------------------------------------------------------------------------------------------------------------------------------------------------------------------------------------------------------------------------------------------------------------------------------------------------------------------------------------------------------------------------------------------------------------------------------------------------------------------------------------------------------|
| Enable/Disable | Click Enable for activating this function. If you click Disable , this function will be closed and all the settings that you adjusted in this page will be invalid. |
| ISP Access Setup | Enter your allocated username, password and authentication parameters according to the information provided by your ISP. Username – Type in the username provided by ISP in this field. Password – Type in the password provided by ISP in this field. Index (1-15) in Schedule Setup - You can type in four sets of time schedule for your request. All the schedules can be set previously in Application >> Schedule web page and you can use the number that you have set in that web page. |
| WAN Connection Detection | Such function allows you to verify whether network connection is alive or not through ARP Detect or Ping Detect. |

| | |
|--------------------------------------------|--------------------------------------------------------------------------------------------------------------------------------------------------------------------------------------------------------------------------------------------------------------------------------------------------------------------------------------------------------------------------------------------------------------------------------------------------------------------------------------------------------------------------------------------------------------------------------------------------------------------------------------------------------------------------------------------------------------------------------------|
| | <p>Mode – Choose ARP Detect or Ping Detect for the system to execute for WAN detection.</p> <p>Ping IP – If you choose Ping Detect as detection mode, you have to type IP address in this field for pinging.</p> <p>TTL (Time to Live) – Displays value for your reference. TTL value is set by telnet command.</p> |
| MTU | It means Max Transmit Unit for packet. The default setting is 1442. |
| PPP/MP Setup | <p>PPP Authentication – Select PAP only or PAP or CHAP for PPP.</p> <p>Idle Timeout – Set the timeout for breaking down the Internet after passing through the time without any action.</p> |
| IP Address Assignment Method (IPCP) | <p>Usually ISP dynamically assigns IP address to you each time you connect to it and request. In some case, your ISP provides service to always assign you the same IP address whenever you request. In this case, you can fill in this IP address in the Fixed IP field. Please contact your ISP before you want to use this function.</p> <p>Fixed IP – Click Yes to use this function and type in a fixed IP address in the box of Fixed IP Address.</p> <p>Default MAC Address – You can use Default MAC Address or specify another MAC address by typing on the boxes of MAC Address for the router.</p> <p>Specify a MAC Address – Type the MAC address for the router manually.</p> |

Details Page for Static or Dynamic IP in WAN1 (Physical Mode: VDSL2)

MPoA is a specification that enables ATM services to be integrated with existing LANs, which use either Ethernet, token-ring or TCP/IP protocols. The goal of MPoA is to allow different LANs to send packets to each other via an ATM backbone.

To use **Static or Dynamic IP** as the accessing protocol of the Internet, select **Static or Dynamic IP** from the **WAN>>Internet Access >>WAN1** page. The following web page will appear.

WAN 1

PPPoE Static or Dynamic IP PPTP/L2TP IPv6

Enable Disable

Keep WAN Connection
 Enable PING to keep alive
PING to the IP:
PING Interval: minute(s)

WAN Connection Detection
Mode:
Ping IP:
TTL:

MTU: (Max:1500)

RIP Protocol
 Enable RIP

WAN IP Network Settings
 Obtain an IP address automatically
Router Name:
Domain Name:
* : Required for some ISPs
 Specify an IP address
IP Address:
Subnet Mask:
Gateway IP Address:

Default MAC Address
 Specify a MAC Address
MAC Address:

DNS Server IP Address
Primary IP Address:
Secondary IP Address:

OK Cancel

Available settings are explained as follows:

| Item | Description |
|---------------------------------|---------------------------------------------------------------------------------------------------------------------------------------------------------------------------------------------------------------------------------------------------------------------------------------------------------------------------------------------------------------------------------------------------------------------------------------------------------------------------------------------------------------------------------------------------------------------------------------------------------|
| Enable/Disable | Click Enable for activating this function. If you click Disable , this function will be closed and all the settings that you adjusted in this page will be invalid. |
| WAN Connection Detection | Such function allows you to verify whether network connection is alive or not through ARP Detect or Ping Detect. Mode – Choose ARP Detect or Ping Detect for the system to execute for WAN detection. Ping IP – If you choose Ping Detect as detection mode, you have to type IP address in this field for pinging. TTL (Time to Live) – Displays value for your reference. TTL value is set by telnet command. |
| Bridge Mode | If you choose Bridged IP as the protocol, you can check this box to invoke the function. The router will work as a bridge modem. |
| WAN IP Network Settings | This group allows you to obtain an IP address automatically and allows you type in IP address manually. Obtain an IP address automatically – Click this button to obtain the IP address automatically. <ul style="list-style-type: none"> ● Router Name – Type in the router name provided by ISP. ● Domain Name – Type in the domain name that you have assigned. Specify an IP address – Click this radio button to specify some data. <ul style="list-style-type: none"> ● IP Address – Type in the private IP address. |

| | |
|------------------------------|-------------------------------------------------------------------------------------------------------------------------------------------------------------------------------------------------------------------------------------------------------------------------------------------------------------------------------------------------------------------------------------------------------------------------------|
| | <ul style="list-style-type: none"> ● Subnet Mask – Type in the subnet mask. ● Gateway IP Address – Type in gateway IP address. <p>Default MAC Address – Type in MAC address for the router. You can use Default MAC Address or specify another MAC address for your necessity.</p> <p>Specify a MAC Address – Type in the MAC address for the router manually.</p> |
| DNS Server IP Address | Type in the primary IP address for the router. If necessary, type in secondary IP address for necessity in the future. |

After finishing all the settings here, please click **OK** to activate them.

Details Page for PPTP/L2TP in WAN1 (Physical Mode: VDSL2)

To use **PPTP/L2TP** as the accessing protocol of the internet, please click the **PPTP/L2TP** tab (L2TP is not used in the UK for Internet access). The following web page will be shown:

WAN >> Internet Access

WAN 1

| PPPoE | Static or Dynamic IP | PPTP/L2TP | IPv6 |
|------------------------------------------------------------------------------------------------------------------------------------------------------------------------------------------------------------------------------------|----------------------|-----------------------------------------------------------------------------------------------------------------------------------------------------------------------------------------------------------------------------------------------------------------------------------------------------------------------------------------------------------------------|------|
| <input type="radio"/> Enable PPTP <input type="radio"/> Enable L2TP <input checked="" type="radio"/> Disable Server Address <input type="text"/> Specify Gateway IP Address <input type="text"/> | | PPP Setup PPP Authentication <input type="text" value="PAP or CHAP"/> Idle Timeout <input type="text" value="-1"/> second(s) IP Address Assignment Method (IPCP) <input type="text" value="WAN IP Alias"/> Fixed IP: <input type="radio"/> Yes <input checked="" type="radio"/> No (Dynamic IP) Fixed IP Address <input type="text"/> | |
| ISP Access Setup Username <input type="text"/> Password <input type="text"/> Index(1-15) in <u>Schedule</u> Setup: => <input type="text"/> , <input type="text"/> , <input type="text"/> , <input type="text"/> | | WAN IP Network Settings <input type="radio"/> Obtain an IP address automatically <input checked="" type="radio"/> Specify an IP address IP Address <input type="text"/> Subnet Mask <input type="text"/> | |
| MTU <input type="text" value="1442"/> (Max:1460) | | | |

Available settings are explained as follows:

| Item | Description |
|-------------------------|----------------------------------------------------------------------------------------------------------------------------------------------------------------------------------------------------------------------------------------------------------------------------------------------------|
| PPTP/L2TP | <p>Enable PPTP- Click this radio button to enable a PPTP client to establish a tunnel to a DSL modem on the WAN interface.</p> <p>Enable L2TP – Not used in the UK</p> <p>Server Address and Gateway IP Address are not normally needed and are set automatically.</p> |
| ISP Access Setup | <p>Username -Type in the username provided by ISP in this field.</p> <p>Password -Type in the password provided by ISP in this field.</p> |

| | |
|-------------------------------------------|----------------------------------------------------------------------------------------------------------------------------------------------------------------------------------------------------------------------------------------------------------------------------------------------------------------------------------------------------------------------------------------------------------------------------------------------------------------------------------------------------------|
| | <p>Index (1-15) in Schedule Setup - You can type in four sets of time schedule for your request. All the schedules can be set previously in Application >> Schedule web page and you can use the number that you have set in that web page.</p> |
| MTU | <p>It means Max Transmit Unit for packet. The default setting is 1442. Do not change it unless you understand why.</p> |
| PPP Setup | <p>PPP Authentication - Select PAP only or PAP or CHAP for PPP.</p> <p>Idle Timeout - Set the timeout for breaking down the Internet after passing through the time without any action.</p> |
| IP Address Assignment Method(IPCP) | <p>Fixed IP - Usually ISPs dynamically assigns IP address to you each time you connect to it and request. In some case, your ISP provides service to always assign you the same IP address whenever you request. In this case, you can fill in this IP address in the Fixed IP field. Please contact your ISP before you want to use this function. Click Yes to use this function and type in a fixed IP address in the box.</p> <p>Fixed IP Address -Type a fixed IP address.</p> |
| WAN IP Network Settings | <p>Obtain an IP address automatically – Click this button to obtain the IP address automatically.</p> <p>Specify an IP address – Click this radio button to specify some data.</p> <ul style="list-style-type: none"> ● IP Address – Type the IP address. ● Subnet Mask – Type the subnet mask. |

After finishing all the settings here, please click **OK** to activate them.

Details Page for PPPoE/PPPoA in WAN1 (Physical Mode: ADSL)

WAN >> Internet Access

WAN 1

| PPPoE / PPPoA | MPoA / Static or Dynamic IP | IPv6 |
|--------------------------------------------------------------------------------------------------------------------------------------------------------------------------------------------------------------|-----------------------------|-------------|
| <input checked="" type="radio"/> Enable <input type="radio"/> Disable | | |
| Modem Settings (for ADSL only) | | |
| Multi-PVC channel | Channel 1 | |
| VPI | 0 | |
| VCI | 38 | |
| Encapsulating Type | VC MUX | |
| Protocol | PPPoA | |
| Modulation | Multimode | |
| PPPoE Pass-through | | |
| <input type="checkbox"/> For Wired LAN <input type="checkbox"/> For Wireless LAN | | |
| WAN Connection Detection | | |
| Mode | ARP Detect | |
| Ping IP | | |
| TTL: | | |
| MTU | 1492 | (Max: 1492) |
| ISP Access Setup | | |
| Service Name (Optional) <input type="text"/> | | |
| Username <input type="text"/> | | |
| Password <input type="text"/> | | |
| <input type="checkbox"/> Separate Account for ADSL | | |
| PPP Authentication <input type="text" value="PAP or CHAP"/> | | |
| Idle Timeout <input type="text" value="-1"/> second(s) | | |
| Fixed IP <input type="radio"/> Yes <input checked="" type="radio"/> No (Dynamic IP) | | |
| Fixed IP Address <input type="text"/> | | |
| <input checked="" type="radio"/> Default MAC Address <input type="radio"/> Specify a MAC Address | | |
| MAC Address: <input type="text" value="00"/> <input type="text" value="1D"/> <input type="text" value="AA"/> <input type="text" value="B8"/> <input type="text" value="15"/> <input type="text" value="01"/> | | |
| Index(1-15) in Schedule Setup: | | |
| => <input type="text"/> , <input type="text"/> , <input type="text"/> , <input type="text"/> | | |

Available settings are explained as follows:

| Item | Description |
|---------------------------------------|-----------------------------------------------------------------------------------------------------------------------------------------------------------------------------------------------------------------------------------------------------------------------------------------------------------------------------------------------------------------------------------------------------------------------------------------------------------------------------------------------------------------------------------------------------------------------------------------------------------------------------------------------------------------------------------------------------------------------------------------------------------------------------------------------------------------------------------------------------------------------------------------------------------------------------------------------|
| Enable/Disable | Click Enable for activating this function. If you click Disable , this function will be closed and all the settings that you adjusted in this page will be invalid. |
| Modem Settings (for ADSL only) | <p>Set up the DSL parameters required by your ISP. These settings configured here are specified for ADSL only.</p> <p>Multi-PVC channel - The selections displayed here are determined by the page of Internet Access >> Multi PVCs. Select M-PVCs Channel means no selection will be chosen.</p> <p>VPI - Type in the value provided by ISP.</p> <p>VCI - Type in the value provided by ISP.</p> <p>(Both of these are pre-set by default to the most common settings for UK ISPs)</p> <p>Encapsulating Type - Drop down the list to choose the type provided by ISP.</p> <p>Protocol - Drop down the list to choose the one (PPPoE or PPPoA) provided by ISP.</p> <p>In the UK, PPA is used most commonly for ADSL and PPPoE for VDSL, but check with your ISP.</p> <p>Modulation –Default setting is Multimode. Choose the one that fits the requirement of your router.</p> |

| | |
|---------------------------------|----------------------------------------------------------------------------------------------------------------------------------------------------------------------------------------------------------------------------------------------------------------------------------------------------------------------------------------------------------------------------------------------------------------------------------------------------------------------------------------------------------------------------------------------------------------------------------------------------------------------------------------------------------------------------------------------------------------------------------------------------------------------------------------------------------------------------------------------------------------------------------------------------------------------------------------------------------------|
| | Modulation Multimode ▾ <div style="border: 1px solid black; padding: 2px; width: fit-content;"> T1.413 G.Lite G.DMT ADSL2(G.992.3) ADSL2 annex M ADSL2+(G.992.5) ADSL2+ annex M Multimode </div> |
| PPPoE Pass-through | <p>The router offers PPPoE dial-up connection. Besides, you also can establish the PPPoE connection directly from local clients to your ISP via the Vigor router. When PPPoA protocol is selected, the PPPoE package transmitted by PC will be transformed into PPPoA package and sent to WAN server. Thus, the PC can access Internet through such direction.</p> <p>For Wired LAN – If you check this box, PCs on the same network can use another set of PPPoE session (different with the Host PC) to access into Internet.</p> <p>For Wireless LAN – It is available for <i>n</i> model. If you check this box, PCs on the same wireless network can use another set of PPPoE session (different with the Host PC) to access into Internet.</p> <p>Note: To have PPPoA Pass-through, please choose PPPoA protocol and check the box(es) here. The router will behave like a modem which only serves the PPPoE client on the LAN.</p> |
| WAN Connection Detection | <p>Such function allows you to verify whether network connection is alive or not through ARP Detect or Ping Detect.</p> <p>Mode – Choose ARP Detect or Ping Detect for the system to execute for WAN detection.</p> <p>Ping IP – If you choose Ping Detect as detection mode, you have to type IP address in this field for pinging.</p> <p>TTL (Time to Live) – Displays value for your reference. TTL value is set by telnet command.</p> |
| MTU | <p>It means Max Transmit Unit for packet. The default setting is 1442.</p> |
| ISP Access Setup | <p>Enter your allocated username, password and authentication parameters according to the information provided by your ISP.</p> <p>Username – Type in the username provided by ISP in this field.</p> <p>Password – Type in the password provided by ISP in this field.</p> <p>Separate Account for ADSL – In default, WAN1 supports VDSL2/ADSL and uses the same PPPoE account and password for connection. If required, you can configure another account and password for ADSL connection by checking this box. If it is checked, the system will ask you</p> |

| | |
|----------------------------|--------------------------------------------------------------------------------------------------------------------------------------------------------------------------------------------------------------------------------------------------------------------------------------------------------------------------------------------------------------------------------------------------------------------------------------------------------------------------------------------------------------------------------------------------------------------------------------------------------------------------------------------------------------------------------------------------------------------------------------------------------------------------------------------------------|
| | <p>to type another group of account and password additionally.</p> <p>PPP Authentication – Select PAP only or PAP or CHAP for PPP.</p> <p>Idle Timeout – Set the timeout for breaking down the Internet after passing through the time without any action.</p> |
| IP Address From ISP | <p>Usually ISP dynamically assigns IP address to you each time you connect to it and request. In some case, your ISP provides service to always assign you the same IP address whenever you request. In this case, you can fill in this IP address in the Fixed IP field.</p> <p>Default MAC Address – You can use Default MAC Address or specify another MAC address by typing on the boxes of MAC Address for the router.</p> <p>Specify a MAC Address – Type the MAC address for the router manually.</p> <p>Index (1-15) in Schedule Setup - You can type in four sets of time schedule for your request. All the schedules can be set previously in Applications >> Schedule web page and you can use the number that you have set in that web page.</p> |

After finishing all the settings here, please click **OK** to activate them.

Details Page for MPoA/Static or Dynamic IP in WAN1 (Physical Mode: ADSL)

MPoA is a specification that enables ATM services to be integrated with existing LANs, which use either Ethernet, token-ring or TCP/IP protocols. The goal of MPoA is to allow different LANs to send packets to each other via an ATM backbone.

To use **MPoA/Static or Dynamic IP** as the accessing protocol of the Internet, select **MPoA /Static or Dynamic IP** from the **WAN>>Internet Access >>WAN1** page. The following web page will appear.

WAN 1

Enable
 Disable

Modem Settings (for ADSL only)
 Multi-PVC channel: Channel 2
 Encapsulation: 1483 Bridged IP LLC
 VPI: 0
 VCI: 88
 Modulation: Multimode

WAN Connection Detection
 Mode: ARP Detect
 Ping IP:
 TTL:

MTU: 1442 (Max:1500)

Bridge Mode
 Enable Bridge Mode

WAN IP Network Settings
 Obtain an IP address automatically
 Router Name: Vigor
 Domain Name:
 * : Required for some ISPs
 Specify an IP address
 IP Address:
 Subnet Mask:
 Gateway IP Address:

Default MAC Address
 Specify a MAC Address
 MAC Address: 00 . 1D . AA . A8 . E7 . 69

DNS Server IP Address
 Primary IP Address: 8.8.8.8
 Secondary IP Address: 8.8.4.4

Available settings are explained as follows:

| Item | Description |
|--------------------------------|-------------------------------------------------------------------------------------------------------------------------------------------------------------------------------------------------------------------------------------------------------------------------------------------------------------------------------------------------------------------------------------------------------------------------------------------------------------------------------------------------------------------------------------------------------------------------------------------------------------------------------------------------------------------------------------------------------------------------------------------------------------------------------------------------------------------------------------------------------------------------------------------------------------------------------------------------------------------------------------------------------------------------------|
| Enable/Disable | Click Enable for activating this function. If you click Disable , this function will be closed and all the settings that you adjusted in this page will be invalid. |
| Modem Settings (for ADSL only) | <p>Set up the DSL parameters required by your ISP. These settings configured here are specified for ADSL only.</p> <p>Multi-PVC channel - The selections displayed here are determined by the page of Internet Access >>Multi PVCs. Select M-PVCs Channel means no selection will be chosen.</p> <p>Encapsulating - Drop down the list to choose the type provided by ISP.</p> <p>VPI - Type in the value provided by ISP.</p> <p>VCI - Type in the value provided by ISP.</p> <p>Modulation –Default setting is Multimode (automatic). Choose the one that fits the requirement of your router.</p> <p>Modulation</p> <div style="border: 1px solid black; padding: 5px; width: fit-content;"> Multimode T1.413 G.Lite G.DMT ADSL2(G.992.3) ADSL2 annex M ADSL2+(G.992.5) ADSL2+ annex M Multimode </div> |

| | |
|---------------------------------|------------------------------------------------------------------------------------------------------------------------------------------------------------------------------------------------------------------------------------------------------------------------------------------------------------------------------------------------------------------------------------------------------------------------------------------------------------------------------------------------------------|
| WAN Connection Detection | <p>Such function allows you to verify whether network connection is alive or not through ARP Detect or Ping Detect (also used for 3G failover).</p> <p>Mode – Choose ARP Detect or Ping Detect for the system to execute for WAN detection.</p> <p>Ping IP – If you choose Ping Detect as detection mode, you have to type IP address in this field for pinging.</p> <p>TTL (Time to Live) – Displays value for your reference. TTL value is set by telnet command.</p> |
| MTU | <p>It means Max Transmit Unit for packet. The default setting is 1492. Do not change this unless you understand why.</p> |
| Bridge Mode | <p>If you choose Bridged IP as the protocol, you can check this box to invoke the function. The router will work as a bridge modem.</p> |
| DNS Server IP Address | <p>Type in the primary IP address for the router. If necessary, type in secondary IP address for necessity in the future.</p> |

After finishing all the settings here, please click **OK** to activate them.

Details Page for PPPoE in WAN2

To choose PPPoE as the accessing protocol of the Internet (normally used for VDSL), select **PPPoE** from the **WAN>>Internet Access >>WAN2** page. The following web page will be shown.

WAN >> Internet Access

WAN 2

| PPPoE | Static or Dynamic IP | PPTP/L2TP | IPv6 |
|--------------------------------------------------------------------------------------------------------------------------------------------------------------------------------------------------------------------------------------|----------------------|-------------------------------------------------------------------------------------------------------------------------------------------------------------------------------------------------------------------------------------------------------------------------------------------------------------------------------------------------------------------------------|------|
| <input type="radio"/> Enable <input checked="" type="radio"/> Disable | | | |
| ISP Access Setup Username: <input type="text"/> Password: <input type="text"/> Index(1-15) in <u>Schedule</u> Setup: => <input type="text"/> , <input type="text"/> , <input type="text"/> , <input type="text"/> | | PPP/MP Setup PPP Authentication: <input type="text" value="PAP or CHAP"/> Idle Timeout: <input type="text" value="-1"/> second(s) IP Address Assignment Method (IPCP) <input type="button" value="WAN IP Alias"/> Fixed IP: <input type="radio"/> Yes <input checked="" type="radio"/> No (Dynamic IP) Fixed IP Address: <input type="text"/> | |
| WAN Connection Detection Mode: <input type="text" value="ARP Detect"/> Ping IP: <input type="text"/> TTL: <input type="text"/> | | <input checked="" type="radio"/> Default MAC Address <input type="radio"/> Specify a MAC Address MAC Address: <input type="text" value="00"/> . <input type="text" value="1D"/> . <input type="text" value="AA"/> . <input type="text" value="A8"/> . <input type="text" value="B7"/> . <input type="text" value="6A"/> | |
| MTU: <input type="text" value="1442"/> (Max:1492) | | | |
| <input type="button" value="OK"/> <input type="button" value="Cancel"/> | | | |

Available settings are explained as follows:

| Item | Description |
|---------------------------------|----------------------------------------------------------------------------------------------------------------------------------------------------------------------------------------------------------------------------------------------------------------------------------------------------------------------------------------------------------------------------------------------------------------------------------------------------------------------------------------------------------------------------------------------------------------------------------------------------------------------------------------------------------------------------------------------------------|
| Enable/Disable | Click Enable for activating this function. If you click Disable , this function will be closed and all the settings that you adjusted in this page will be invalid. |
| ISP Access Setup | <p>Enter your allocated username, password and authentication parameters according to the information provided by your ISP.</p> <p>Username – Type in the username provided by ISP in this field. The maximum length of the user name you can set is 63 characters.</p> <p>Password – Type in the password provided by ISP in this field. The maximum length of the password you can set is 62 characters.</p> <p>Index (1-15) in Schedule Setup - You can type in four sets of time schedule for your request. All the schedules can be set previously in Application >> Schedule web page and you can use the number that you have set in that web page.</p> |
| WAN Connection Detection | Such function allows you to verify whether network connection is alive or not through ARP Detect or Ping Detect. |

| | |
|--------------------------------------------|--------------------------------------------------------------------------------------------------------------------------------------------------------------------------------------------------------------------------------------------------------------------------------------------------------------------------------------------------------------------------------------------------------------------------------------------------------------------------------------------------------------------------------------------------------------------------------------------------------------------------------------------------------------------------------------------------------------------------------------|
| | <p>Mode – Choose ARP Detect or Ping Detect for the system to execute for WAN detection.</p> <p>Ping IP – If you choose Ping Detect as detection mode, you have to type IP address in this field for pinging.</p> <p>TTL (Time to Live) – Displays value for your reference. TTL value is set by telnet command.</p> |
| MTU | It means Max Transmit Unit for packet. The default setting is 1492. |
| PPP/MP Setup | <p>PPP Authentication – Select PAP only or PAP or CHAP for PPP.</p> <p>Idle Timeout – Set the timeout for breaking down the Internet after passing through the time without any action.</p> |
| IP Address Assignment Method (IPCP) | <p>Usually ISP dynamically assigns IP address to you each time you connect to it and request. In some case, your ISP provides service to always assign you the same IP address whenever you request. In this case, you can fill in this IP address in the Fixed IP field. Please contact your ISP before you want to use this function.</p> <p>Fixed IP – Click Yes to use this function and type in a fixed IP address in the box of Fixed IP Address.</p> <p>Default MAC Address – You can use Default MAC Address or specify another MAC address by typing on the boxes of MAC Address for the router.</p> <p>Specify a MAC Address – Type the MAC address for the router manually.</p> |

After finishing all the settings here, please click **OK** to activate them.

Details Page for Static or Dynamic IP in WAN2

For static IP mode, you usually receive a fixed public IP address or a public subnet, namely multiple public IP addresses from your DSL or Cable ISP service providers. In most cases, a Cable service provider will offer a fixed public IP, while a DSL service provider will offer a public subnet. If you have a public subnet, you could assign an IP address or many IP address to the WAN interface.

To use **Static or Dynamic IP** as the accessing protocol of the internet, please click the **Static or Dynamic IP** tab. The following web page will be shown.

WAN 2

PPPoE Static or Dynamic IP PPTP/L2TP IPv6

Enable Disable

Keep WAN Connection

Enable PING to keep alive

PING to the IP:

PING Interval: minute(s)

WAN Connection Detection

Mode: (v)

Ping IP:

TTL:

MTU: (Max:1500)

WAN IP Network Settings

Obtain an IP address automatically

Router Name:

Domain Name:

* : Required for some ISPs

DHCP Client Identifier for some ISP

Enable

Username:

Password:

Specify an IP address

IP Address:

Subnet Mask:

Gateway IP Address:

Default MAC Address

Specify a MAC Address

MAC Address:

DNS Server IP Address

Primary IP Address:

Secondary IP Address:

OK Cancel

Available settings are explained as follows:

| Item | Description |
|---------------------------------|------------------------------------------------------------------------------------------------------------------------------------------------------------------------------------------------------------------------------------------------------------------------------------------------------------------------------------------------------------------------------------------------------------------------------------------------------------------------|
| Enable / Disable | Click Enable for activating this function. If you click Disable , this function will be closed and all the settings that you adjusted in this page will be invalid. |
| Keep WAN Connection | Normally, this function is designed for Dynamic IP environments because some ISPs will drop connections if there is no traffic within certain periods of time. Check Enable PING to keep alive box to activate this function. PING to the IP - If you enable the PING function, please specify the IP address for the system to PING it for keeping alive. PING Interval - Enter the interval for the system to execute the PING operation. |
| WAN Connection Detection | Such function allows you to verify whether network connection is alive or not through ARP Detect or Ping Detect. Mode – Choose ARP Detect or Ping Detect for the system to execute for WAN detection. Ping IP – If you choose Ping Detect as detection mode, you have to type IP address in this field for pinging. TTL (Time to Live) – Displays value for your reference. TTL value is set by telnet command. |
| MTU | It means Max Transmit Unit for packet. The default setting is 1492. |

| | |
|---------------------------------------|------------------------------------------------------------------------------------------------------------------------------------------------------------------------------------------------------------------------------------------------------------------------------------------------------------------------------------------------------------------------------------------------------------------------------------------------------------------------------------------------------------------------------------------------------------------------------------------------------------------------------------------------------------------------------------------------------------------------------------------------------------------------------------------------------------------------------------------------------------------------------------------------------------------------------------------------------------------------------------------------------------------------------------------------------------------------------------------------------------------------------------------------------------------------------------------------------------------------------------------------------------------------------------------------------------------------------------------------------------------------------------------------------------------------------------------------------------------------------------------------------------------------------------------------------------------------------------------------------------------------------------|
| <p>WAN IP Network Settings</p> | <p>This group allows you to obtain an IP address automatically and allows you type in IP address manually.</p> <p>Obtain an IP address automatically – Click this button to obtain the IP address automatically if you want to use Dynamic IP mode.</p> <ul style="list-style-type: none"> ● Router Name: Type in the router name provided by ISP. ● Domain Name: Type in the domain name that you have assigned. <p>DHCP Client Identifier for some ISP</p> <ul style="list-style-type: none"> ● Enable: Check the box to specify username and password as the DHCP client identifier for some ISP. ● Username: Type a name as username. The maximum length of the user name you can set is 63 characters. ● Password: Type a password. The maximum length of the password you can set is 62 characters. <p>Specify an IP address – Click this radio button to specify some data if you want to use Static IP mode.</p> <ul style="list-style-type: none"> ● IP Address: Type the IP address. ● Subnet Mask: Type the subnet mask. ● Gateway IP Address: Type the gateway IP address. <p>Default MAC Address: Click this radio button to use default MAC address for the router.</p> <p>Specify a MAC Address: Some Cable service providers specify a specific MAC address for access authentication. In such cases you need to click the Specify a MAC Address and enter the MAC address in the MAC Address field.</p> |
| <p>DNS Server IP Address</p> | <p>Type in the primary IP address for the router if you want to use Static IP mode. If necessary, type in secondary IP address for necessity in the future.</p> |

After finishing all the settings here, please click **OK** to activate them.

Details Page for 3G/4G USB Modem (PPP mode) in WAN3

To use **3G/4G USB Modem (PPP mode)** as the accessing protocol of the internet, please choose **Internet Access** from **WAN** menu. Then, select **3G/4G USB Modem (PPP mode)** for WAN3. The following web page will be shown.

WAN >> Internet Access i

WAN 3 | [Modem Support List](#) |

3G/4G USB Modem(PPP mode) Enable Disable

SIM PIN code

Modem Initial String
(Default:AT&FE0V1X1&D2&C1S0=0)

APN Name

Modem Initial String2

Modem Dial String
(Default:ATDT*99#, CDMA:ATDT#777, TD-SCDMA:ATDT*98* 1#)

Service Name (Optional)

PPP Username (Optional)

PPP Password (Optional)

PPP Authentication

Index(1-15) in [Schedule](#) Setup:
=> , , ,

WAN Connection Detection

Mode

Ping IP

TTL:

Available settings are explained as follows:

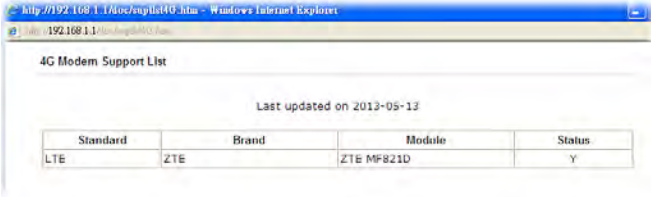
| Item | Description |
|------------------------------------|---------------------------------------------------------------------------------------------------------------------------------------------------------------------------------------|
| Modem Support List | It lists all of the modems supported by such router.  |
| 3G /4G USB Modem (PPP mode) | Click Enable for activating this function. If you click Disable , this function will be closed and all the settings that you adjusted in this page will be invalid. |
| SIM PIN code | Type PIN code of the SIM card that will be used to access Internet. The maximum length of the PIN code you can set is 15 characters. |
| Modem Initial String | Such value is used to initialize USB modem. Please use the default value. If you have any question, please contact to your ISP. The maximum length of the string you can set is 47 |

| | |
|---------------------------------------|-------------------------------------------------------------------------------------------------------------------------------------------------------------------------------------------------------------------------------------------------------------------------------------------------------------------------------------------------------------------------------------------------------------------------------------------------------------|
| | characters. |
| APN Name | APN means Access Point Name which is provided and required by some ISPs. Type the name and click Apply . The maximum length of the name you can set is 43 characters. |
| Modem Initial String2 | The initial string 1 is shared with APN. In some cases, user may need another initial AT command to restrict 3G band or do any special settings. The maximum length of the string you can set is 47 characters. |
| Modem Dial String | Such value is used to dial through USB mode. Please use the default value. If you have any question, please contact to your ISP. The maximum length of the string you can set is 31 characters. |
| Service Name | Enter the description of the specific network service. |
| PPP Username | Type the PPP username (optional). The maximum length of the name you can set is 63 characters. |
| PPP Password | Type the PPP password (optional). The maximum length of the password you can set is 62 characters. |
| PPP Authentication | Select PAP only or PAP or CHAP for PPP. |
| Index (1-15) in Schedule Setup | You can type in four sets of time schedule for your request. All the schedules can be set previously in Application >> Schedule web page and you can use the number that you have set in that web page |
| WAN Connection Detection | Such function allows you to verify whether network connection is alive or not through ARP Detect or Ping Detect. Mode – Choose ARP Detect or Ping Detect for the system to execute for WAN detection. Ping IP – If you choose Ping Detect as detection mode, you have to type IP address in this field for pinging. TTL (Time to Live) – Displays value for your reference. TTL value is set by telnet command. |

After finishing all the settings here, please click **OK** to activate them.

Details Page for 4G USB Modem (DHCP mode) in WAN3

To use **4G USB Modem (DHCP mode)** as the accessing protocol of the internet, please choose **Internet Access** from **WAN** menu. Then, select **4G USB Modem (DHCP mode)** for WAN3. The following web page will be shown.

WAN >> Internet Access



WAN 3 | [Modem Support List](#) |

4G USB Modem(DHCP mode) Enable Disable

SIM PIN code

Network Mode 4G/3G/2G (Default: 4G/3G/2G)

APN Name

MTU 1380 (Default: 1380)

LTE software version ---

LTE hardware version ---

WAN Connection Detection

Mode ARP Detect

Ping IP

TTL:

Available settings are explained as follows:

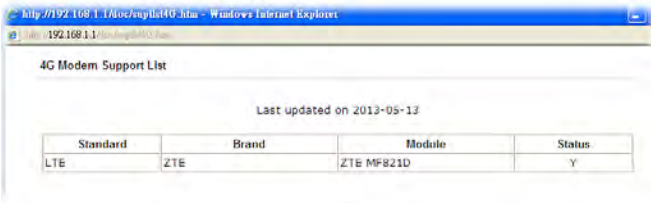
| Item | Description |
|---------------------------------|------------------------------------------------------------------------------------------------------------------------------------------------------------------------------------------------------------------|
| Modem Support List | <p>It lists all of the modems supported by such router.</p>  |
| 4G USB Modem (DHCP mode) | <p>Click Enable for activating this function. If you click Disable, this function will be closed and all the settings that you adjusted in this page will be invalid.</p> |
| SIM PIN code | <p>Type PIN code of the SIM card that will be used to access Internet.</p> <p>The maximum length of the PIN code you can set is 19 characters.</p> |
| Network Mode | <p>Force Vigor router to connect Internet with the mode specified here. If you choose 4G/3G/2G as network mode, the router will choose a suitable one according to the actual wireless signal automatically.</p> |
| APN Name | <p>APN means Access Point Name which is provided and required by some ISPs. Type the name and click Apply.</p> <p>The maximum length of the name you can set is 47 characters.</p> |

| | |
|---------------------------------|-------------------------------------------------------------------------------------------------------------------------------------------------------------------------------------------------------------------------------------------------------------------------------------------------------------------------------------------------------------------------------------------------------------------------------------------------------------|
| MTU | It means Max Transmit Unit for packet. The default setting is 1380. |
| WAN Connection Detection | Such function allows you to verify whether network connection is alive or not through ARP Detect or Ping Detect. Mode – Choose ARP Detect or Ping Detect for the system to execute for WAN detection. Ping IP – If you choose Ping Detect as detection mode, you have to type IP address in this field for pinging. TTL (Time to Live) – Displays value for your reference. TTL value is set by telnet command. |

After finishing all the settings here, please click **OK** to activate them.

Details Page for IPv6 – Offline in WAN1/WAN2/WAN3

When Offline is selected, the IPv6 connection will be disabled.

WAN >> Internet Access

WAN 1

| PPPoE | Static or Dynamic IP | PPTP | IPv6 |
|-----------------------------|----------------------|---------|------|
| Internet Access Mode | | | |
| Connection Type | | Offline | |

Details Page for IPv6 – PPP in WAN1/WAN2

During the procedure of IPv4 PPPoE connection, we can get the IPv6 Link Local Address between the gateway and Vigor router through IPv6CP. Later, use DHCPv6 or Accept RA to acquire the IPv6 prefix address (such as: 2001:B010:7300:200::/64) offered by the ISP. In addition, PCs under LAN also can have the public IPv6 address for Internet access by means of the generated prefix.

No need to type any other information for PPP mode.

WAN >> Internet Access

WAN 1

| PPPoE | Static or Dynamic IP | PPTP | IPv6 |
|--------------------------------------------------------|----------------------|------|------|
| Internet Access Mode | | | |
| Connection Type | | PPP | |
| Note : IPv4 WAN setting should be PPPoE client. | | | |

Below shows an example for successful IPv6 connection based on PPP mode.

Online Status

Physical Connection System Uptime: 0:2:32

| IPv4 | | IPv6 | |
|----------------------------------------------------------------------------------------------|-------------------|------------------------|-----------------|
| LAN Status | | | |
| IP Address | | | |
| 2001:B010:7300:201:21D:AFF:FEA6:2568/64 (Global) | | | |
| FE80::21D:AFF:FEA6:2568/64 (Link) | | | |
| TX Packets | RX Packets | TX Bytes | RX Bytes |
| 7 | 4 | 690 | 328 |
| WAN2 IPv6 Status >> Drop PPP | | | |
| Enable | Mode | Up Time | |
| Yes | PPP | 0:02:08 | |
| IP | | Gateway IP | |
| 2001:B010:7300:201:21D:AFF:FEA6:256A/128 (Global) | | FE80::90:1A00:242:AD52 | |
| FE80::1D:AFF:FEA6:256A/128 (Link) | | | |
| DNS IP | | | |
| 2001:8000:168::1 | | | |
| 2001:8000:168::2 | | | |
| TX Packets | RX Packets | TX Bytes | RX Bytes |
| 7 | 9 | 544 | 1126 |

Note: At present, the **IPv6 prefix** can be acquired via the PPPoE mode connection which is available for the areas such as Taiwan (hinet), the Netherlands, Australia and UK.

Details Page for IPv6 – TSPC in WAN1/WAN2/WAN3

Tunnel setup protocol client (TSPC) is an application which could help you to connect to IPv6 network easily.

Please make sure your IPv4 WAN connection is OK and apply one free account from hexago (<http://gogonet.gogo6.com/page/freenet6-account>) before you try to use TSPC for network connection. TSPC would connect to tunnel broker and requests a tunnel according to the specifications inside the configuration file. It gets a public IPv6 IP address and an IPv6 prefix from the tunnel broker and then monitors the state of the tunnel in background.

After getting the IPv6 prefix and starting router advertisement daemon (RADVD), the PC behind this router can directly connect to IPv6 the Internet.

WAN >> Internet Access

WAN 1

| PPPoE | Static or Dynamic IP | PPTP | IPv6 |
|-----------------------------|----------------------|---------------------------------------|------|
| Internet Access Mode | | | |
| Connection Type | | TSPC <input type="button" value="v"/> | |
| TSPC Configuration | | | |
| Username | | <input type="text"/> | |
| Password | | <input type="text"/> | |
| Confirm Password | | <input type="text"/> | |
| Tunnel Broker | | <input type="text"/> | |

Available settings are explained as follows:

| Item | Description |
|-------------------------|------------------------------------------------------------------------------------------------------------------------------------------------------------------------------------------------------------------------------------------------------------------------------------------|
| Username | Type the name obtained from the broker. It is suggested for you to apply another username and password for http://gogonet.gogo6.com/page/freenet6-account . The maximum length of the name you can set is 63 characters. |
| Password | Type the password assigned with the user name. The maximum length of the name you can set is 19 characters. |
| Confirm Password | Type the password again to make the confirmation. |
| Tunnel Broker | Type the address for the tunnel broker IP, FQDN or an optional port number. |

After finished the above settings, click **OK** to save the settings.

Details Page for IPv6 – AICCU in WAN1/WAN2/WAN3

WAN >> Internet Access



WAN 2

| PPPoE | Static or Dynamic IP | PPTP | IPv6 |
|---------------------------------------------------------------------------------------------------|----------------------|---------------------------------------------|------|
| Internet Access Mode | | | |
| Connection Type | | AICCU | |
| AICCU Configuration | | | |
| <input type="checkbox"/> Always On | | | |
| Username | | <input type="text"/> | |
| Password | | <input type="text"/> | |
| Confirm Password | | <input type="text"/> | |
| Tunnel Broker | | tic.sixxs.net | |
| Subnet Prefix | | <input type="text"/> / <input type="text"/> | |
| <p>Note: If "Always On" is not enabled, AICCU connection would only retry three times.</p> | | | |
| OK | | Cancel | |

Available settings are explained as follows:

| Item | Description |
|------------------|-----------------------------------------------------------------------------------------------------------------------------------------------------------------------------------------------------------------------------------------------------------------|
| Always On | Check this box to keep the network connection always. |
| Username | Type the name obtained from the broker. Please apply new account at http://www.sixxs.net/ . It is suggested for you to apply another username and password. The maximum length of the name you can set is 19 characters. |
| Password | Type the password assigned with the user name. The maximum length of the password you can set is 19 characters. |

| | |
|-------------------------|----------------------------------------------------------------------------------------------------------------------------------|
| Confirm Password | Type the password again to make the confirmation. |
| Tunnel Broker | Type the address for the tunnel broker IP, FQDN or an optional port number. |
| Subnet Prefix | Type the subnet prefix address getting from service provider. The maximum length of the prefix you can set is 128 characters. |

After finished the above settings, click **OK** to save the settings.

Details Page for IPv6 – DHCPv6 Client in WAN1/WAN2

DHCPv6 client mode would use DHCPv6 protocol to obtain IPv6 address from server.

WAN >> Internet Access

WAN 1

| PPPoE | Static or Dynamic IP | PPTP | IPv6 |
|------------------------------------|----------------------|------------------------------------------------------------------------------------------------|------|
| Internet Access Mode | | | |
| Connection Type | | DHCPv6 Client ▼ | |
| DHCPv6 Client Configuration | | | |
| Identity Association | | <input checked="" type="radio"/> Prefix Delegation <input type="radio"/> Non-temporary Address | |
| IAID (Identity Association ID) | | 4230640032 | |

Available settings are explained as follows:

| Item | Description |
|-----------------------------|----------------------------------------------------------------------------------------------|
| Identify Association | Choose Prefix Delegation or Non-temporary Address as the identify association. |
| IAID | Type a number as IAID. |

After finished the above settings, click **OK** to save the settings.

Details Page for IPv6 – Static IPv6 in WAN1/WAN2

This type allows you to setup static IPv6 address for WAN interface.

WAN >> Internet Access

WAN 1

| PPPoE | Static or Dynamic IP | PPTP | IPv6 | | | | | | |
|------------------------------------------------------------------------------------------------------------------------------------------------------------------------------------------------------------------------------------------------------|----------------------------|-------|------|-------|----------------------------|-------|--|--|--|
| <p>Internet Access Mode</p> <p>Connection Type Static IPv6 ▾</p> | | | | | | | | | |
| <p>Static IPv6 Address configuration</p> <p>IPv6 Address <input type="text"/> / Prefix Length <input type="text"/> Add Delete</p> | | | | | | | | | |
| <p>Current IPv6 Address Table</p> <table border="1" style="width: 100%;"> <thead> <tr> <th>Index</th> <th>IPv6 Address/Prefix Length</th> <th>Scope</th> </tr> </thead> <tbody> <tr> <td> </td> <td> </td> <td> </td> </tr> </tbody> </table> | | | | Index | IPv6 Address/Prefix Length | Scope | | | |
| Index | IPv6 Address/Prefix Length | Scope | | | | | | | |
| | | | | | | | | | |
| <p>Static IPv6 Gateway configuration</p> <p>IPv6 Gateway Address <input type="text" value="::"/></p> | | | | | | | | | |

OK Cancel

Available settings are explained as follows:

| Item | Description |
|------------------------------------------|--------------------------------------------------------------------------------------------------------------------------------------------------------------------------------------------------------------------------------------------------|
| Static IPv6 Address configuration | <p>IPv6 Address – Type the IPv6 Static IP Address.</p> <p>Prefix Length – Type the fixed value for prefix length.</p> <p>Add – Click it to add a new entry.</p> <p>Delete – Click it to remove an existed entry.</p> |
| Current IPv6 Address Table | Display current interface IPv6 address. |
| Static IPv6 Gateway Configuration | IPv6 Gateway Address - Type your IPv6 gateway address here. |

After finished the above settings, click **OK** to save the settings.

Details Page for IPv6 – 6in4 Static Tunnel in WAN1/WAN2

This type allows you to setup 6in4 Static Tunnel for WAN interface.

Such mode allows the router to access IPv6 network through IPv4 network.

However, 6in4 offers a prefix outside of 2002::0/16. So, you can use a fixed endpoint rather than any cast endpoint. The mode has more reliability.

WAN >> Internet Access



WAN 1

| PPPoE | Static or Dynamic IP | PPTP/L2TP | IPv6 |
|------------------------------|----------------------|----------------------------------|------------------------------------------------|
| Internet Access Mode | | | |
| Connection Type | | 6in4 Static Tunnel | |
| 6in4 Static Tunnel | | | |
| Remote Endpoint IPv4 Address | | <input type="text"/> | |
| 6in4 IPv6 Address | | <input type="text"/> | / <input type="text" value="64"/> (default:64) |
| LAN Routed Prefix | | <input type="text"/> | / <input type="text" value="64"/> (default:64) |
| Tunnel TTL | | <input type="text" value="255"/> | (default:255) |
| OK | | Cancel | |

Available settings are explained as follows:

| Item | Description |
|-------------------------------------|--------------------------------------------------------------------------------|
| Remote Endpoint IPv4 Address | Type the static IPv4 address for the remote server. |
| 6in4 IPv6 Address | Type the static IPv6 address for IPv4 tunnel with the value for prefix length. |
| LAN Routed Prefix | Type the static IPv6 address for LAN routing with the value for prefix length. |
| Tunnel TTL | Type the number for the data lifetime in tunnel. |

After finished the above settings, click **OK** to save the settings.

Below shows an example for successful IPv6 connection based on 6in4 Static Tunnel mode.

Online Status

| Physical Connection | | System Uptime: 0day 0:4:16 | |
|----------------------------------------------------|--------------------|----------------------------|-----------------|
| IPv4 | IPv6 | | |
| LAN Status | | | |
| IP Address | | | |
| 2001:4DD0:FF00:83E4:21D:AAFF:FE83:11B4/64 (Global) | | | |
| FE80::21D:AAFF:FE83:11B4/64 (Link) | | | |
| TX Packets | RX Packets | TX Bytes | RX Bytes |
| 14 | 80 | 1244 | 6815 |
| WAN1 IPv6 Status | | | |
| Enable | Mode | Up Time | |
| Yes | 6in4 Static Tunnel | 0:04:07 | |
| IP | | Gateway IP | |
| 2001:4DD0:FF10:83E4::2131/64 (Global) | | --- | |
| FE80::C0A8:651D/128 (Link) | | | |
| TX Packets | RX Packets | TX Bytes | RX Bytes |
| 3 | 26 | 211 | 2302 |

Details Page for IPv6 – 6rd in WAN1/WAN2

This type allows you to setup 6rd for WAN interface.

WAN 1

| PPPoE | Static or Dynamic IP | PPTP/L2TP | IPv6 |
|-----------------------------|----------------------|----------------------------------------------------------------------------|------|
| Internet Access Mode | | | |
| Connection Type | | 6rd | |
| 6rd Settings | | | |
| 6rd Mode | | <input type="radio"/> Auto 6rd <input checked="" type="radio"/> Static 6rd | |
| Static 6rd Settings | | | |
| IPv4 Border Relay: | 192.168.101.111 | | |
| IPv4 Mask Length: | 0 | | |
| 6rd Prefix: | 2001:E41:: | | |
| 6rd Prefix Length: | 32 | | |
| | | <input type="button" value="OK"/> <input type="button" value="Cancel"/> | |

Available settings are explained as follows:

| Item | Description |
|--------------------------|---------------------------------------------------------------------------------------------------------------------------------------------------------------------|
| 6rd Mode | Auto 6rd – Retrieve 6rd prefix automatically from 6rd service provider. The IPv4 WAN must be set as "DHCP". Static 6rd - Set 6rd options manually. |
| IPv4 Border Relay | Type the IPv4 addresses of the 6rd Border Relay for a given 6rd domain. |
| IPv4 Mask Length | Type a number of high-order bits that are identical across all CE IPv4 addresses within a given 6rd domain. It may be any value between 0 and 32. |

| | |
|--------------------------|------------------------------------------------------------------------|
| 6rd Prefix | Type the 6rd IPv6 address. |
| 6rd Prefix Length | Type the IPv6 prefix length for the 6rd IPv6 prefix in number of bits. |

After finished the above settings, click **OK** to save the settings.

Below shows an example for successful IPv6 connection based on 6rd mode.

Online Status

| Physical Connection | | System Uptime: 0day 0:9:15 | |
|----------------------------------------------------|-------------------|----------------------------|-----------------|
| IPv4 | IPv6 | | |
| LAN Status | | | |
| IP Address | | | |
| 2001:E41:A865:1D00:21D:AAFF:FE83:11B4/64 (Global) | | | |
| FE80::21D:AAFF:FE83:11B4/64 (Link) | | | |
| TX Packets | RX Packets | TX Bytes | RX Bytes |
| 15 | 113 | 1354 | 18040 |
| WAN1 IPv6 Status | | | |
| Enable | Mode | Up Time | |
| Yes | 6rd | 0:09:06 | |
| IP | | Gateway IP | |
| 2001:E41:A865:1D01:21D:AAFF:FE83:11B5/128 (Global) | | --- | |
| FE80::C0A8:651D/128 (Link) | | | |
| TX Packets | RX Packets | TX Bytes | RX Bytes |
| 13 | 29 | 967 | 2620 |

3.1.4 Multi-PVC

This router allows you to create multi-PVC for different data transferring for using. Simply go to **Internet Access** and select **Multi-PVC** page.

General

The system allows you to set up to eight channels which are ready for choosing as the first PVC line that will be used as multi-PVC.

WAN >> Multi-PVC

Multi-PVC

General **Advanced**

| Channel | Enable | WAN Type | VPI/VCI | VLAN Tag | Port-based Bridge |
|---------|--------|----------------|---------|----------|-------------------------------------------------------------------------------------------------------------------------------------------------|
| 1 | Yes | ADSL | 8/35 | None | |
| 2 | No | Ethernet(WAN2) | | None | |
| 3 | No | ADSL | 1/43 | None | |
| 4. WAN4 | No | ADSL | 1/44 | None | <input type="checkbox"/> Enable <input type="checkbox"/> P1 <input type="checkbox"/> P2 <input type="checkbox"/> P3 <input type="checkbox"/> P4 |
| 5. WAN5 | No | ADSL | 1/45 | None | <input type="checkbox"/> Enable <input type="checkbox"/> P1 <input type="checkbox"/> P2 <input type="checkbox"/> P3 <input type="checkbox"/> P4 |
| 6. WAN6 | No | ADSL | 1/46 | None | <input type="checkbox"/> Enable <input type="checkbox"/> P1 <input type="checkbox"/> P2 <input type="checkbox"/> P3 <input type="checkbox"/> P4 |
| 7. | No | ADSL | 1/47 | None | <input type="checkbox"/> Enable <input type="checkbox"/> P1 <input type="checkbox"/> P2 <input type="checkbox"/> P3 <input type="checkbox"/> P4 |
| 8. | No | ADSL | 1/48 | None | <input type="checkbox"/> Enable <input type="checkbox"/> P1 <input type="checkbox"/> P2 <input type="checkbox"/> P3 <input type="checkbox"/> P4 |

Available settings are explained as follows:

| Item | Description |
|--------------------------|----------------------------------------------------------------------------------------------------------------------------------------------------------------------------------------------------------------------------------------------------------------------------------------------------------------------------------------------------|
| Channel | Display the number of each channel. Channels 1 and 2 are used by the Internet Access web user interface and can not be configured here. Channels 4 ~ 8 are configurable. |
| Enable | Display whether the settings in this channel are enabled (Yes) or not (No). |
| WAN Type | Displays the physical medium that the channel will use. |
| VPI/VCI | Display the value for VPI and VCI. |
| VLAN Tag | Displays the VLAN tag value that will be used for the packets traveling on this channel. |
| Port-based Bridge | The network traffic flowing on each channel will be identified by the system via their VLAN Tags. Channels using the same WAN type may not configure the same VLAN tag value. Enable - Check this box to enable the port-based bridge function on this channel. P1 ~ P4 – Check the box(es) to build bridge connection on LAN. |

Click any index (7~8) to get the following web page:

WAN >> Multi-PVC >> Channel 7

Multi-PVC Channel 7: Enable Disable

General Settings

VPI:

VCI:

Protocol:

Encapsulation:

Add VLAN Header

VLAN Tag:

Priority:

ATM QoS

QoS Type:

PCR:

SCR:

MBS:

Bridge mode

Enable

Physical Members

P1 P2 P3 P4

Available settings are explained as follows:

| Item | Description |
|-------------------------------|---------------------------------------------------------------------------------------------------------------------------------------------------------------------------------------------------------------------------------------------------------------------------------------------------------------------------------------------------------------------------------------------------------------------------------------------------------------------------------------------------------------------------------------------------------------------------------------------------------------------------------------------------------------------------------------------------------------------------------------------------------------------------------------------------------------------------------------------------------------------------------------------------------------------------------------------------------------------------------------------------------------------------------------------------------------------------------------------------------------------------------------------------------------------------------------------------------------------------------------------------------------------------------------------------------------------------------------------------------------------------------------------------------------------------------------------------------------------------------------------------------------|
| Multi-VLAN Channel 7/8 | <p>Enable – Click it to enable the configuration of this channel.</p> <p>Disable – Click it to disable the configuration of this channel.</p> |
| General Settings | <p>VPI - Type in the value provided by your ISP.</p> <p>VCI - Type in the value provided by your ISP.</p> <p>Protocol - Select a proper protocol for this channel.</p> <p>Encapsulation - Choose a proper type for this channel. The types will be different according to the protocol setting that you choose.</p> <div style="display: flex; justify-content: center; align-items: center; margin: 10px 0;"> <div style="border: 1px solid gray; padding: 2px; margin-right: 5px;"> <input type="text" value="VC MUX"/> <input type="text" value="VC MUX"/> <input type="text" value="LLC/SNAP"/> </div> <div style="border: 1px solid gray; padding: 2px;"> <input type="text" value="1483 Route IP LLC"/> <input type="text" value="1483 Bridged IP LLC"/> <input type="text" value="1483 Route IP LLC"/> <input type="text" value="1483 Bridged IP VC-Mux"/> <input type="text" value="1483 Routed IP VC-Mux(IPoA)"/> <input type="text" value="1483 Bridged IP(IPoE)"/> </div> </div> <p>Add VLAN Header – Check the box to enable the following two options.</p> <p>VLAN Tag – Type the value as the VLAN ID number. Valid settings are in the range from 1 to 4095. The network traffic flowing on each channel will be identified by the system via their VLAN Tags. Channels using the same WAN type may not configure the same VLAN tag value.</p> <p>Priority – Choose the number to determine the packet</p> |

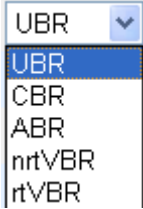
| | |
|--------------------|----------------------------------------------------------------------------------------------------------------------------------------------------------------------------------------------------------------------------------------------------------------------------------------------------------|
| | priority for such VLAN. The range is from 0 to 7. |
| ATM OoS | <p>Such option is available only when WAN1 is connected with the type of ADSL.</p> <p>QoS Type - Select a proper QoS type for the channel.</p>  <p>Type the values for PCR, SCR and MBS respectively.</p> |
| Bridge mode | <p>Enable – Click it to enable Bridge mode for such channel.</p> <p>Physical Members – Group the physical ports by checking the corresponding check box(es) for applying the bridge connection.</p> |

After finished the above settings, click **OK** to save the settings.

WAN links for Channel 4, 5 and 6 are provided for router-borne application such as **TR-069**. The settings must be applied and obtained from your ISP. For your special request, please contact with your ISP and then click WAN link of Channel 4, 5 and 6 to configure your router.

WAN >> Multi-PVC >> Channel 4

Multi-PVC Channel 4: Enable Disable

| | |
|-------------------------------------------------------------------------------------------------------------------------------------------------------------------------------------------------------------------------------------------------------------------------------------------------------------------------------------------------------------------------------|------------------------------------------------------------------------------------------------------------------------------------------------------------------------------------------------------|
| <p>General Settings</p> <p>VPI <input type="text" value="1"/></p> <p>VCI <input type="text" value="44"/></p> <p>Protocol <input type="text" value="PPPoA"/></p> <p>Encapsulation <input type="text" value="VC MUX"/></p> <p><input type="checkbox"/> Add VLAN Header</p> <p>VLAN Tag <input type="text" value="0"/></p> <p>Priority <input type="text" value="0"/></p> | <p>ATM QoS</p> <p>QoS Type <input type="text" value="UBR"/></p> <p>PCR <input type="text" value="0"/></p> <p>SCR <input type="text" value="0"/></p> <p>MBS <input type="text" value="0"/></p> |
|-------------------------------------------------------------------------------------------------------------------------------------------------------------------------------------------------------------------------------------------------------------------------------------------------------------------------------------------------------------------------------|------------------------------------------------------------------------------------------------------------------------------------------------------------------------------------------------------|

Open Port-based Bridge Connection for this Channel

Physical Members

P1 P2 P3 P4

Open WAN Interface for this Channel

WAN Application:

WAN Connection Detection

Mode

Ping IP

| | |
|------------------------------------------------------------------------------------------------------------------------------------------------------------------------------------------------------------------------------------------------------------------------------------------------------------------------------------------------------------------------------------------------------------------------------------------------------------------------------------------------------------------------------------------------|----------------------------------------------------------------------------------------------------------------------------------------------------------------------------------------------------------------------------------------------------------------------------------------------------------------------------------------------------------------------------------------------------------------------------------------------------------------------------------------------------------------------------------------------------------------------------------------------------------------------------|
| <p>PPPoE/PPPoA Client</p> <p>ISP Access Setup</p> <p>ISP Name <input type="text"/></p> <p>Username <input type="text"/></p> <p>Password <input type="text"/></p> <p>PPP Authentication <input type="text" value="PAP or CHAP"/></p> <p><input checked="" type="checkbox"/> Always On</p> <p>Idle Timeout <input type="text" value="-1"/> second(s)</p> <p>IP Address From ISP</p> <p>Fixed IP <input type="radio"/> Yes <input checked="" type="radio"/> No (Dynamic IP)</p> <p>Fixed IP Address <input type="text"/></p> | <p>MPoA (RFC1483/2684)</p> <p><input type="radio"/> Obtain an IP address automatically</p> <p>Router Name <input type="text" value="Vigor"/> *</p> <p>Domain Name <input type="text"/> *</p> <p><small>*: Required for some ISPs</small></p> <p><input checked="" type="radio"/> Specify an IP address</p> <p>IP Address <input type="text"/></p> <p>Subnet Mask <input type="text"/></p> <p>Gateway IP Address <input type="text"/></p> <p>DNS Server IP Address</p> <p>Primary IP Address <input type="text" value="8.8.8.8"/></p> <p>Secondary IP Address <input type="text" value="8.8.4.4"/></p> |
|------------------------------------------------------------------------------------------------------------------------------------------------------------------------------------------------------------------------------------------------------------------------------------------------------------------------------------------------------------------------------------------------------------------------------------------------------------------------------------------------------------------------------------------------|----------------------------------------------------------------------------------------------------------------------------------------------------------------------------------------------------------------------------------------------------------------------------------------------------------------------------------------------------------------------------------------------------------------------------------------------------------------------------------------------------------------------------------------------------------------------------------------------------------------------------|

Available settings are explained as follows:

| Item | Description |
|---------------------------------|-------------------------------------------------------------------------------------------------------------------------------------------------|
| Multi-VLAN Channel 4/5/6 | Enable – Click it to enable the configuration of this channel. Disable –Click it to disable the configuration of this channel. |
| General Settings | VPI - Type in the value provided by your ISP. |

| | |
|------------------------------------------------------------------|----------------------------------------------------------------------------------------------------------------------------------------------------------------------------------------------------------------------------------------------------------------------------------------------------------------------------------------------------------------------------------------------------------------------------------------------------------------------------------------------------------------------------------------------------------------------------------------------------------------------------------------------------------------------------------------------------------------------------------------------------------------------------------------------------------------------------------------------------------------------------|
| | <p>VCI - Type in the value provided by your ISP.</p> <p>Protocol - Select a proper protocol for this channel.</p> <p>Encapsulation - Choose a proper type for this channel. The types will be different according to the protocol setting that you choose.</p>  <p>Add VLAN Header – Check the box to enable the following two options.</p> <p>VLAN Tag – Type the value as the VLAN ID number. Valid settings are in the range from 1 to 4095. The network traffic flowing on each channel will be identified by the system via their VLAN Tags. Channels using the same WAN type may not configure the same VLAN tag value.</p> <p>Priority – Choose the number to determine the packet priority for such VLAN. The range is from 0 to 7.</p> |
| <p>Open Port-based Bridge Connection for this Channel</p> | <p>The settings here will create a bridge between the LAN ports selected and the WAN. The WAN interface of the bridge connection will be built upon the WAN type selected using the VLAN tag configured.</p> <p>Physical Members – Group the physical ports by checking the corresponding check box(es) for applying the port-based bridge connection.</p> |
| <p>Open WAN Interface for this Channel</p> | <p>Check the box to enable relating function.</p> <p>WAN Application –</p> <ul style="list-style-type: none"> ● Management – It can be specified for general management (Web configuration/telnet/TR069). If you choose Management, the configuration for this VLAN will be effective for Web configuration/telnet/TR069. ● IPTV - The IPTV configuration will allow the WAN interface to send IGMP packets to IPTV servers. ● VoIP - The VoIP configuration will allow the WAN interface to send VoIP packets to servers. |
| <p>ISP Access Setup for PPPoE/PPPoA Client</p> | <p>Enter your allocated username, password and authentication parameters according to the information provided by your ISP.</p> <p>ISP Name – Type in the name of your ISP.</p> <p>Username – Type in the username provided by ISP in this field. The maximum length of the name you can set is 80 characters.</p> <p>Password – Type in the password provided by ISP in this field. The maximum length of the password you can set is 48 characters.</p> <p>PPP Authentication – Select PAP only or PAP or CHAP for PPP.</p> <p>Always On – Check it to keep the network connection</p> |

| | |
|----------------------------------------------------------------|----------------------------------------------------------------------------------------------------------------------------------------------------------------------------------------------------------------------------------------------------------------------------------------------------------------------------------------------------------------------------------------------------------------------------------------------------------------------------------------------------------------------------------------------------------------------------------------------------------------------------------------------------------------------------------------------------------------------------------------------------------------------------------------------------------------------------------------------|
| | <p>always.</p> <p>Idle Timeout – Set the timeout for breaking down the Internet after passing through the time without any action.</p> <p>Fixed IP – Click Yes to use this function and type in a fixed IP address in the box of Fixed IP Address.</p> |
| <p>WAN IP Network Settings for Static or Dynamic IP</p> | <p>Obtain an IP address automatically – Click this button to obtain the IP address automatically.</p> <ul style="list-style-type: none"> ● Router Name – Type in the router name provided by ISP. ● Domain Name – Type in the domain name that you have assigned. <p>Specify an IP address – Click this radio button to specify some data.</p> <ul style="list-style-type: none"> ● IP Address – Type in the private IP address. ● Subnet Mask – Type in the subnet mask. ● Gateway IP Address – Type in gateway IP address. <p>DNS Server IP Address - Type in the primary IP address for the router if you want to use Static IP mode. If necessary, type in secondary IP address for necessity in the future.</p> |

After finished the above settings, click **OK** to save the settings and return to previous page.

Advanced

Such configuration is applied to upstream packets. Such information will be provided by ISP. Please contact with your ISP for detailed information.

Note that such web page is available only when ADSL is selected as WAN type.

WAN >> Multi-PVCs

Multi-PVCs

| General | | Advanced | | | | |
|---------|--------------------------------------|--------------------------------|--------------------------------|--------------------------------|------------------------------------------|--|
| ATM QoS | | | | | | |
| Channel | QoS Type | PCR | SCR | MBS | PVC to PVC Binding | |
| 1. | UBR <input type="button" value="v"/> | <input type="text" value="0"/> | <input type="text" value="0"/> | <input type="text" value="0"/> | <input type="button" value="v"/> Disable | |
| 2. | UBR <input type="button" value="v"/> | <input type="text" value="0"/> | <input type="text" value="0"/> | <input type="text" value="0"/> | <input type="button" value="v"/> Disable | |
| 3. | UBR <input type="button" value="v"/> | <input type="text" value="0"/> | <input type="text" value="0"/> | <input type="text" value="0"/> | <input type="button" value="v"/> Disable | |
| 4. | UBR <input type="button" value="v"/> | <input type="text" value="0"/> | <input type="text" value="0"/> | <input type="text" value="0"/> | <input type="button" value="v"/> Disable | |
| 5. | UBR <input type="button" value="v"/> | <input type="text" value="0"/> | <input type="text" value="0"/> | <input type="text" value="0"/> | <input type="button" value="v"/> Disable | |
| 6. | UBR <input type="button" value="v"/> | <input type="text" value="0"/> | <input type="text" value="0"/> | <input type="text" value="0"/> | <input type="button" value="v"/> Disable | |
| 7. | UBR <input type="button" value="v"/> | <input type="text" value="0"/> | <input type="text" value="0"/> | <input type="text" value="0"/> | <input type="button" value="v"/> Disable | |
| 8. | UBR <input type="button" value="v"/> | <input type="text" value="0"/> | <input type="text" value="0"/> | <input type="text" value="0"/> | <input type="button" value="v"/> Disable | |

Note:1.If the parameters in the ATM QoS settings are set to zero,then their default settings will be used. Also,PCR(max)=ADSL Up Speed /53/8 .

2.Multiple channels may use the same ADSL channel link through the PVC Binding configuration. The PVC Binding configuration is only supported for channels using ADSL,please make sure the channel that you are binding to is using ADSL as its WAN type.The binding will work only under PPPoE and MPoA 1483 Bridge mode.

Available settings are explained as follows:

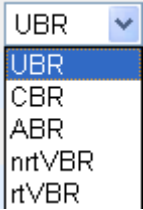
| Item | Description |
|---------------------------|--------------------------------------------------------------------------------------------------------------------------------------------------------------------------------------------------------------------------------------------------------------------------|
| QoS Type | <p>Select a proper QoS type for the channel according to the information that your ISP provides.</p>  |
| PCR | It represents Peak Cell Rate. The default setting is "0". |
| SCR | It represents Sustainable Cell Rate. The value of SCR must be smaller than PCR. |
| MBS | It represents Maximum Burst Size. The range of the value is 10 to 50. |
| PVC to PVC Binding | <p>It allows the PVC channel to use the same ADSL connection settings of another PVC channel. Please choose the PVC channel (must be enabled first) via the drop down list.</p> <p>This option is available only when the PVC channel is enabled on the General tab.</p> |

After finished the above settings, click **OK** to save the settings

3.2 LAN

Local Area Network (LAN) is a subnet regulated and ruled by router. The design of network structure is related to what type of public IP addresses coming from your ISP.



3.2.1 Basics of LAN

The most generic function of Vigor router is NAT. It creates a private subnet of your own. As mentioned previously, the router will talk to other public hosts on the Internet by using public IP address and talking to local hosts by using its private IP address. What NAT does is to translate the packets from public IP address to private IP address to forward the right packets to the right host and vice versa. Besides, Vigor router has a built-in DHCP server that assigns private IP address to each local host. See the following diagram for a briefly understanding.

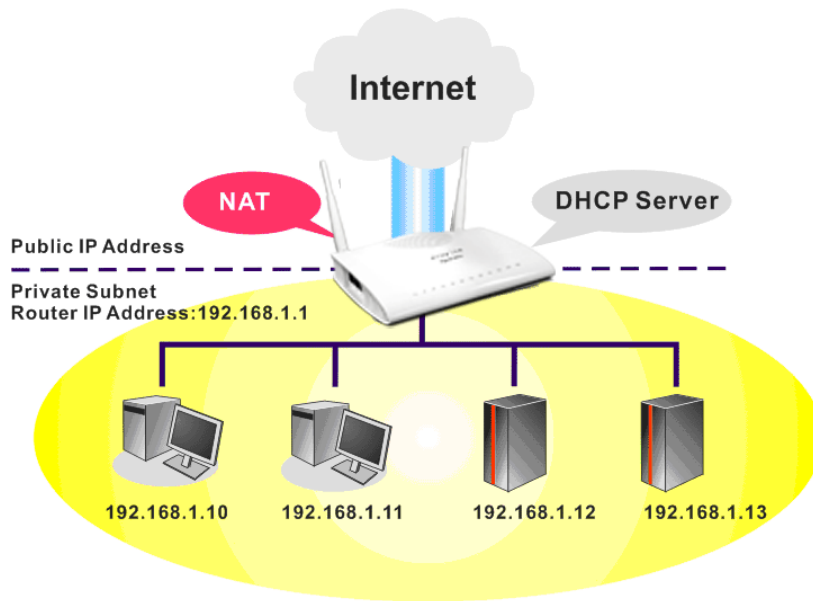

In some special case, you may have a public IP subnet from your ISP such as 220.135.240.0/24. This means that you can set up a public subnet or call second subnet that each host is equipped with a public IP address. As a part of the public subnet, the Vigor router will serve for IP routing to help hosts in the public subnet to communicate with other public hosts or servers outside. Therefore, the router should be set as the gateway for public hosts.

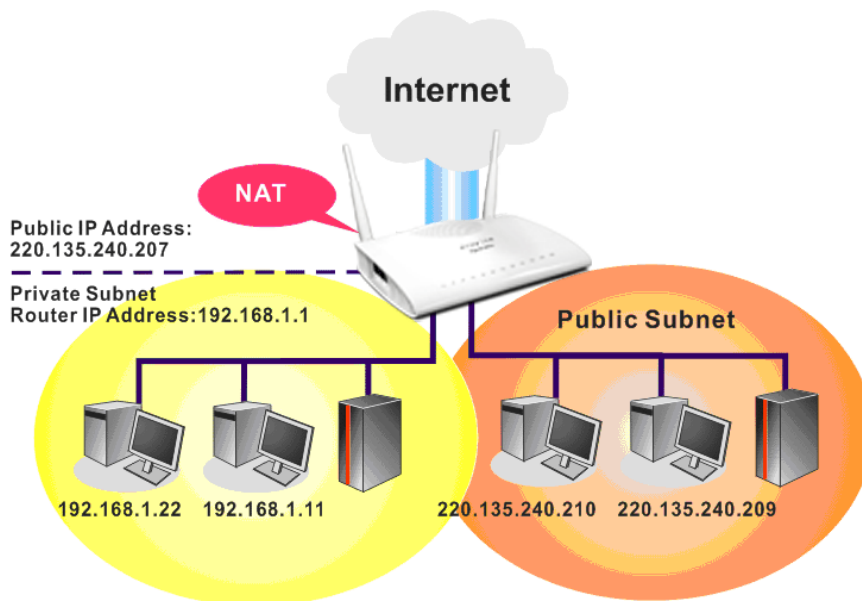

What is Routing Information Protocol (RIP)

Vigor router will exchange routing information with neighboring routers using the RIP to accomplish IP routing. This allows users to change the information of the router such as IP address and the routers will automatically inform for each other.

3.2.2 General Setup

This page provides you the general settings for LAN. Click **LAN** to open the LAN settings page and choose **General Setup**. Only Vigor 2760, only LAN1 is available.

LAN >> General Setup

General Setup

| Index | Status | DHCP | IP Address | | |
|-------|--------------------------|-------------------------------------|-------------|--------------|------|
| LAN 1 | V | V | 192.168.1.1 | Details Page | IPv6 |
| LAN 2 | <input type="checkbox"/> | <input checked="" type="checkbox"/> | 192.168.2.1 | Details Page | |

Advanced You can configure DHCP server options here.

Force router to use "DNS server IP address" settings specified in LAN1

Inter-LAN Routing

| Subnet | LAN 1 | LAN 2 |
|--------|-------------------------------------|-------------------------------------|
| LAN 1 | <input checked="" type="checkbox"/> | <input type="checkbox"/> |
| LAN 2 | <input type="checkbox"/> | <input checked="" type="checkbox"/> |

Note: LAN 2 is available when VLAN is enabled.

OK

Available settings are explained as follows:

| Item | Description | | | | | | | | |
|----------------------|------------------------------------------------------------------------------------------------------------------------------------------------------------------------------------------------------------------------------------------------------------------------------------------------------------------------------------------------------------------------------------------------------------------------------------------------------------------------------------------------------------------------------------------------------------------------------------------------------------------------------------------------------------------------------------------------------------------------------------------------------------------------------------------------------------------------------------------------------------------------------------------------------------------------------------------------------------------------------------------------------------------------------------------------------------------------------------------------------------------------------------------------------------------------------------------------------------------------------|-----------|---------------|-----------|------|--|--|--|--|
| General Setup | <p>Allow to configure settings for each subnet respectively.</p> <p>Index - Display all of the LAN items.</p> <p>Status- Basically, LAN1 status is enabled in default. On Vigor 2760, only one LAN subnet is supported.</p> <p>DHCP- DHCP is enabled by default.</p> <p>IP Address - Display the IP address for each LAN item.</p> <p>Details Page - Click it to access into the setting page.</p> <p>IPv6 – Click it to access into the settings page of IPv6.</p> | | | | | | | | |
| Advanced | <p>DHCP packets can be processed by adding option number and data information when such function is enabled.</p> <p>LAN >> General Setup</p> <div data-bbox="699 1525 1406 1861" style="border: 1px solid black; padding: 5px;"> <p>DHCP Options Status</p> <p><input type="radio"/> Enable <input checked="" type="radio"/> Disable</p> <p>Options List</p> <table border="1" style="width: 100%; border-collapse: collapse;"> <thead> <tr> <th>Index</th> <th>Option Number</th> <th>Ascii/Hex</th> <th>Data</th> </tr> </thead> <tbody> <tr> <td colspan="4" style="height: 50px;"></td> </tr> </tbody> </table> <p>Option Number: <input type="text"/></p> <p>Data Type: <input checked="" type="radio"/> Ascii <input type="radio"/> Hex (Example of Hex Data Type Input Format:0xff 0x00 0xc0 0xa8)</p> <p>Data: <input type="text"/></p> <p style="text-align: right;"><input type="button" value="Add"/> <input type="button" value="Delete"/></p> </div> <p>Note: Maximum number of custom DHCP option is five.</p> <p style="text-align: center;">OK</p> <p>Enable/Disable – Enable/Disable the function of DHCP Option. Each DHCP option is composed by an option number with data. For example,</p> | Index | Option Number | Ascii/Hex | Data | | | | |
| Index | Option Number | Ascii/Hex | Data | | | | | | |
| | | | | | | | | | |

| | |
|---------------------------------------------------------------|--------------------------------------------------------------------------------------------------------------------------------------------------------------------------------------------------------------------------------------------------------------------------------------------------------------------------------------------------------------------------------------------------------------|
| | <p>Option number: 100 Data: abcd</p> <p>When such function is enabled, the specified values for DHCP option will be seen in DHCP reply packets.</p> <p>Option Number – Type a number for such function.</p> <p>Data Type – Choose the type (ASCII or Hex) for the data to be stored.</p> <p>Data – Type the content of the data to be processed by the function of DHCP option.</p> |
| <p>Force router to use DNS server IP address</p> | <p>Force Vigor router to use DNS servers configured in LAN1/LAN2/LAN3/LAN4/LAN5/LAN6 instead of DNS servers given by the Internet Access server (PPPoE, PPTP, L2TP or DHCP server).</p> |

When you finish the configuration, please click **OK** to save and exit this page.

Details Page for LAN1 – Ethernet TCP/IP and DHCP Setup

There are two configuration pages for LAN1, Ethernet TCP/IP and DHCP Setup (based on IPv4) and IPv6 Setup. Click the tab for each type and refer to the following explanations for detailed information.

LAN >> General Setup

| LAN 1 Ethernet TCP / IP and DHCP Setup | LAN 1 IPv6 Setup |
|----------------------------------------------------------------------------------------------------------------------------------------------------------------|----------------------------------------------------------------------------------------------------------------------------------------------------------------------------------------------------------------------------------------------------------------------------------------------------------------------------------------------------------------------------------------------------------------------------------------------------------------------------------------------------------------------------------------------------------------------------------------------------------------------------|
| Network Configuration For NAT Usage IP Address <input type="text" value="192.168.1.1"/> Subnet Mask <input type="text" value="255.255.255.0"/> | DHCP Server Configuration <input checked="" type="radio"/> Enable Server <input type="radio"/> Disable Server <input type="checkbox"/> Enable Relay Agent Start IP Address <input type="text" value="192.168.1.10"/> IP Pool Counts <input type="text" value="200"/> Gateway IP Address <input type="text" value="192.168.1.1"/> Lease Time <input type="text" value="86400"/> (s) <input checked="" type="checkbox"/> Retrieve IPs from inactive clients periodically DNS Server IP Address Primary IP Address <input type="text"/> Secondary IP Address <input type="text"/> |

OK

Available settings are explained as follows:

| Item | Description |
|----------------------------------|-----------------------------------------------------------------------------------------------------------------------------------------------------------------------------------------------------------------------------------------------------------------------------------------------------------------------------------------------------------------------------------------------------------------------------------------------------------------------------------------------------------------------------------------------------------------------------------------------------------------------------------------------------------------------------------------------------------------------------------------------------------------------------------------------------------------------------------------------------------------------------------------------------------------------------------------------------------------------------------------------------------------------------------------------------------------------------------------------------------------------------------------------------------------------------------------------------------------------------------------------------------------|
| Network Configuration | <p>For NAT Usage,</p> <p>IP Address - Type in private IP address for connecting to a local private network (Default: 192.168.1.1).</p> <p>Subnet Mask - Type in an address code that determines the size of the network. (Default: 255.255.255.0/ 24)</p> |
| DHCP Server Configuration | <p>DHCP stands for Dynamic Host Configuration Protocol. The router by factory default acts a DHCP server for your network so it automatically dispatch related IP settings to any local user configured as a DHCP client. It is highly recommended that you leave the router enabled as a DHCP server if you do not have a DHCP server for your network.</p> <p>If you want to use another DHCP server in the network other than the Vigor Router's, you can let Relay Agent help you to redirect the DHCP request to the specified location.</p> <p>Enable Server - Let the router assign IP address to every host in the LAN.</p> <p>Disable Server – Let you manually assign IP address to every host in the LAN.</p> <p>DHCP Server IP Address – It is available when Enable Relay Agent is checked. Set the IP address of the DHCP server you are going to use so the Relay Agent can help to forward the DHCP request to the DHCP server.</p> <p>Start IP Address - Enter a value of the IP address pool for the DHCP server to start with when issuing IP addresses. If the 1st IP address of your router is 192.168.1.1, the starting IP address must be 192.168.1.2 or greater, but smaller than 192.168.1.254.</p> |

IP Pool Counts - Enter the maximum number of PCs that you want the DHCP server to assign IP addresses to. The default is 50 and the maximum is 253.

Gateway IP Address - Enter a value of the gateway IP address for the DHCP server. The value is usually as same as the 1st IP address of the router, which means the router is the default gateway.

Lease Time - Enter the time to determine how long the IP address assigned by DHCP server can be used.

Retrieve IPs from inactive clients periodically – Whenever a DHCP client requests an IP address from the LAN DHCP server, the server will give out an IP to this client for a certain amount of time (e.g., 1 day). However, even if this client only uses the IP for say 5 minutes, the server still "reserves" 1 day for that client. Because a DHCP server only has a limited number of IPs to lease to its DHCP clients, soon enough all the IPs will be used out and then no one will be able to get any IPs from this server anymore. Therefore, this feature is used to get the IP back from inactive clients (i.e. doesn't use the IP but the server still reserves the IP for him).

DNS Server IP Address

DNS stands for Domain Name System. Every Internet host must have a unique IP address, also they may have a human-friendly, easy to remember name such as www.yahoo.com. The DNS server converts the user-friendly name into its equivalent IP address.

Primary IP Address - You must specify a DNS server IP address here because your ISP should provide you with usually more than one DNS Server. If your ISP does not provide it, the router will automatically apply default DNS Server IP address: 194.109.6.66 to this field.

Secondary IP Address - You can specify secondary DNS server IP address here because your ISP often provides you more than one DNS Server. If your ISP does not provide it, the router will automatically apply default secondary DNS Server IP address: 194.98.0.1 to this field.

The default DNS Server IP address can be found via Online Status:

Online Status

| Physical Connection | | System Uptime: 22:22:45 | |
|---------------------|------------|-------------------------|--|
| IPV4 | IPV6 | Primary DNS: 8.8.8.8 | |
| LAN Status | | Secondary DNS: 8.8.4.4 | |
| IP Address | TX Packets | RX Packets | |
| 192.168.1.1 | 0 | 41533 | |

If both the Primary IP and Secondary IP Address fields are left empty, the router will assign its own IP address to local users as a DNS proxy server and maintain a DNS cache.

If the IP address of a domain name is already in the DNS cache, the router will resolve the domain name immediately. Otherwise, the router forwards the DNS query packet to the external DNS server by establishing a WAN (e.g. DSL/Cable) connection.

When you finish the configuration, please click **OK** to save and exit this page.

Details Page for LAN1 – IPv6 Setup

There are two configuration pages for LAN1, Ethernet TCP/IP and DHCP Setup (based on IPv4) and IPv6 Setup. Click the tab for each type and refer to the following explanations for detailed information. Below shows the settings page for IPv6.

LAN >> General Setup

LAN 1 Ethernet TCP / IP and DHCP Setup
LAN 1 IPv6 Setup

Router Advertisement Server

Enable Disable

Advertisement Lifetime Seconds (Range : 600 - 9000)

DHCPv6 Server

Enable Server Disable Server

Start IPv6 Address

End IPv6 Address

DNS Server IPv6 Address

Primary DNS Server

Secondary DNS Server

Static IPv6 Address

IPv6 Address / Prefix Length

Current IPv6 Address Table

| Index | IPv6 Address/Prefix Length | Scope |
|-------|-----------------------------|-------|
| 1 | FE80::21D:A&FF:FE88:1500/64 | Link |

It provides 2 daemons for LAN side IPv6 address configuration. One is **RADVD**(stateless) and the other is **DHCPv6 Server** (Stateful).

Available settings are explained as follows:

| Item | Description |
|------------------------------------|-------------------------------------------------------------------------------------------------------------------------------------------------------------------------------------------------------------------------------------------------------------------------------------------------------------------------------------------------------------------------------------------------------------------------------------------------------------------------------------------------------------------------------------------------------------------------------------------------------------------------------------------------------------------------------|
| Router Advertisement Server | <p>Enable – Click it to enable router advertisement server. The router advertisement daemon (radvd) sends Router Advertisement messages, specified by RFC 2461, to a local Ethernet LAN periodically and when requested by a node sending a Router Solicitation message. These messages are required for IPv6 stateless auto-configuration.</p> <p>Disable – Click it to disable RADVD server.</p> <p>Advertisement Lifetime - The lifetime associated with the default router in units of seconds. It's used to control the lifetime of the prefix. The maximum value corresponds to 18.2 hours. A lifetime of 0 indicates that the router is not a</p> |

| | |
|------------------------------------------|-------------------------------------------------------------------------------------------------------------------------------------------------------------------------------------------------------------------------------------------------------------------------------------------------------------------------------------------|
| | default router and should not appear on the default router list. |
| DHCPv6 Server | <p>Enable Server –Click it to enable DHCPv6 server. DHCPv6 Server could assign IPv6 address to PC according to the Start/End IPv6 address configuration.</p> <p>Disable Server –Click it to disable DHCPv6 server.</p> <p>Start IPv6 Address / End IPv6 Address –Type the start and end address for IPv6 server.</p> |
| DNS Server IPv6 Address | <p>Primary DNS Server – Type the IPv6 address for Primary DNS server.</p> <p>Secondary DNS Server –Type another IPv6 address for DNS server if required.</p> |
| Static IPv6 Address configuration | <p>IPv6 Address –Type static IPv6 address for LAN.</p> <p>Prefix Length – Type the fixed value for prefix length.</p> <p>Add – Click it to add a new entry.</p> <p>Delete – Click it to remove an existed entry.</p> |
| Current IPv6 Address Table | Display current used IPv6 addresses. |

When you finish the configuration, please click **OK** to save and exit this page.

Details Page for LAN2

LAN >> General Setup

Lan 2 Ethernet TCP / IP and DHCP Setup

| | |
|----------------------------------------------------------------------------------------------------------------------------------------------------------------------------------------------------------------------------------------------------------------------------------------------------------------------------------------------------------------------------|------------------------------------------------------------------------------------------------------------------------------------------------------------------------------------------------------------------------------------------------------------------------------------------------------------------------------------------------------------------------------------------------------------------------------------------------------------------------------------------------------------------------------------------------------------------------------------------------------------------------------------------------------------------------------------------------------------------|
| <p>Network Configuration</p> <p><input type="radio"/> Enable <input checked="" type="radio"/> Disable</p> <p><input checked="" type="radio"/> For NAT Usage</p> <p>IP Address <input type="text" value="192.168.2.1"/></p> <p>Subnet Mask <input type="text" value="255.255.255.0"/></p> <p>Note: Disable LAN & Enable LAN shouldn't be in the same subnet.</p> | <p>DHCP Server Configuration</p> <p><input checked="" type="radio"/> Enable Server <input type="radio"/> Disable Server</p> <p><input type="checkbox"/> Enable Relay Agent</p> <p>Start IP Address <input type="text" value="192.168.2.10"/></p> <p>IP Pool Counts <input type="text" value="100"/></p> <p>Gateway IP Address <input type="text" value="192.168.2.1"/></p> <p>Lease Time <input type="text" value="259200"/> (s)</p> <p><input checked="" type="checkbox"/> Retrieve IPs from inactive clients periodically</p> <hr/> <p>DNS Server IP Address</p> <p>Primary IP Address <input type="text" value="0.0.0.0"/></p> <p>Secondary IP Address <input type="text" value="0.0.0.0"/></p> |
|----------------------------------------------------------------------------------------------------------------------------------------------------------------------------------------------------------------------------------------------------------------------------------------------------------------------------------------------------------------------------|------------------------------------------------------------------------------------------------------------------------------------------------------------------------------------------------------------------------------------------------------------------------------------------------------------------------------------------------------------------------------------------------------------------------------------------------------------------------------------------------------------------------------------------------------------------------------------------------------------------------------------------------------------------------------------------------------------------|

OK

Available settings are explained as follows:

| Item | Description |
|----------------------------------|------------------------------------------------------------------------------------------------------------------------------------------------------------------------------------------------------------------------------------------------------------------------------------------------------------------------------------------------------------------------------------------------------------------------------------------------------------------------------------------------------------------------------------------------------------------------------------------------------------------------------------------------------------------------------------------------------------------------------------------------------------------------------------------------------------------------------------------------------------------------------------------------------------------------------------------------------------------------------------------------------------------------------------------------------------------------------------------------------------------------------------------------------------------------------------------------------------|
| Network Configuration | <p>Enable/Disable - Click Enable to enable such configuration; click Disable to disable such configuration.</p> <p>For NAT Usage - Click this radio button to invoke NAT function (mandatory for IPv4).</p> <p>IP Address - Type in private IP address for connecting to a local private network (Default: 192.168.1.1).</p> <p>Subnet Mask - Type in an address code that determines the size of the network. (Default: 255.255.255.0/ 24)</p> |
| DHCP Server Configuration | <p>DHCP stands for Dynamic Host Configuration Protocol. The router by factory default acts a DHCP server for your network so it automatically dispatch related IP settings to any local user configured as a DHCP client. It is highly recommended that you leave the router enabled as a DHCP server if you do not have a DHCP server for your network.</p> <p>Enable Server - Let the router assign IP address to every host in the LAN.</p> <p>Disable Server - Let you manually assign IP address to every host in the LAN.</p> <p>DHCP Server IP Address - It is available when Enable</p> <p>Start IP Address - Enter a value of the IP address pool for the DHCP server to start with when issuing IP addresses. If the 1st IP address of your router is 192.168.1.1, the starting IP address must be 192.168.1.2 or greater, but smaller than 192.168.1.254.</p> <p>IP Pool Counts - Enter the maximum number of PCs that you want the DHCP server to assign IP addresses to. The default is 50 and the maximum is 253.</p> <p>Gateway IP Address - Enter a value of the gateway IP address for the DHCP server. The value is usually as same</p> |

| | <p>as the 1st IP address of the router, which means the router is the default gateway.</p> <p>Lease Time - Enter the time to determine how long the IP address assigned by DHCP server can be used.</p> <p>Retrieve IPs from inactive clients periodically – Whenever a DHCP client requests an IP address from the LAN DHCP server, the server will give out an IP to this client for a certain amount of time (e.g., 1 day). However, even if this client only uses the IP for say 5 minutes, the server still "reserves" 1 day for that client. Because a DHCP server only has a limited number of IPs to lease to its DHCP clients, soon enough all the IPs will be used out and then no one will be able to get any IPs from this server anymore. Therefore, this feature is used to get the IP back from inactive clients (i.e. doesn't use the IP but the server still reserves the IP for him).</p> | | | | | | | | | | | | | | | | |
|-------------------------------------|----------------------------------------------------------------------------------------------------------------------------------------------------------------------------------------------------------------------------------------------------------------------------------------------------------------------------------------------------------------------------------------------------------------------------------------------------------------------------------------------------------------------------------------------------------------------------------------------------------------------------------------------------------------------------------------------------------------------------------------------------------------------------------------------------------------------------------------------------------------------------------------------------------------------------------------------------------------------------------------------------------------------------------------------------------------------------------------------------------------------------------------------------------------------------------------------------------------------------------------------------------------------------------------------------------------------------------------------------------------------------------------------------------------------------------------------------------------------------------------------------------------------------------------------------------------------------------------------------------------------------------------------------------------------------------------------------------------------------------------------------------------------------------------------------------------------------------------------------------------------------------------------------------------------------------------|------------------------|--|------|--|------------|----------------------|------------------------|--|------------|------------|------------|--|-------------|---|-------|--|
| <p>DNS Server IP Address</p> | <p>DNS stands for Domain Name System. Every Internet host must have a unique IP address, also they may have a human-friendly, easy to remember name such as www.yahoo.com. The DNS server converts the user-friendly name into its equivalent IP address.</p> <p>Primary IP Address - You must specify a DNS server IP address here because your ISP should provide you with usually more than one DNS Server. If your ISP does not provide it, the router will automatically apply default DNS Server IP address: 194.109.6.66 to this field.</p> <p>Secondary IP Address - You can specify secondary DNS server IP address here because your ISP often provides you more than one DNS Server. If your ISP does not provide it, the router will automatically apply default secondary DNS Server IP address: 194.98.0.1 to this field.</p> <p>The default DNS Server IP address can be found via Online Status:</p> <p>Online Status</p> <hr/> <p>Physical Connection System Uptime: 22:22:45</p> <table border="1" data-bbox="703 1469 1394 1541"> <thead> <tr> <th colspan="2">IPv4</th> <th colspan="2">IPv6</th> </tr> </thead> <tbody> <tr> <td>LAN Status</td> <td>Primary DNS: 8.8.8.8</td> <td colspan="2">Secondary DNS: 8.8.4.4</td> </tr> <tr> <td>IP Address</td> <td>TX Packets</td> <td colspan="2">RX Packets</td> </tr> <tr> <td>192.168.1.1</td> <td>0</td> <td colspan="2">41533</td> </tr> </tbody> </table> <p>If both the Primary IP and Secondary IP Address fields are left empty, the router will assign its own IP address to local users as a DNS proxy server and maintain a DNS cache.</p> <p>If the IP address of a domain name is already in the DNS cache, the router will resolve the domain name immediately. Otherwise, the router forwards the DNS query packet to the external DNS server by establishing a WAN (e.g. DSL/Cable) connection.</p> | IPv4 | | IPv6 | | LAN Status | Primary DNS: 8.8.8.8 | Secondary DNS: 8.8.4.4 | | IP Address | TX Packets | RX Packets | | 192.168.1.1 | 0 | 41533 | |
| IPv4 | | IPv6 | | | | | | | | | | | | | | | |
| LAN Status | Primary DNS: 8.8.8.8 | Secondary DNS: 8.8.4.4 | | | | | | | | | | | | | | | |
| IP Address | TX Packets | RX Packets | | | | | | | | | | | | | | | |
| 192.168.1.1 | 0 | 41533 | | | | | | | | | | | | | | | |

When you finish the configuration, please click **OK** to save and exit this page.

3.2.3 VLAN

With the 4-port Gigabit switch on the LAN side, Vigor router provides extremely high speed connectivity for the highest speed local data transfer of any server or local PCs.

Port-Based VLAN

Relative to tag-based VLAN which groups clients with an identifier, port-based VLAN uses physical ports (P1 ~ P4) to separate the clients into different VLAN groups.

Go to **LAN** page and select **VLAN**. The following page will appear. Click **Enable** to invoke VLAN function.

Below is an example page in Vigor2760n:

LAN >> VLAN Configuration

VLAN Configuration

Enable

| VLAN | LAN | | | | Wireless LAN | | | |
|-------|-------------------------------------|-------------------------------------|-------------------------------------|-------------------------------------|-------------------------------------|-------------------------------------|-------------------------------------|-------------------------------------|
| | P1 | P2 | P3 | P4 | SSID1 | SSID2 | SSID3 | SSID4 |
| VLAN0 | <input checked="" type="checkbox"/> | <input checked="" type="checkbox"/> | <input checked="" type="checkbox"/> | <input type="checkbox"/> | <input checked="" type="checkbox"/> | <input checked="" type="checkbox"/> | <input checked="" type="checkbox"/> | <input checked="" type="checkbox"/> |
| VLAN1 | <input type="checkbox"/> | <input type="checkbox"/> | <input type="checkbox"/> | <input checked="" type="checkbox"/> | <input type="checkbox"/> | <input type="checkbox"/> | <input type="checkbox"/> | <input type="checkbox"/> |
| VLAN2 | <input type="checkbox"/> | <input type="checkbox"/> | <input type="checkbox"/> | <input type="checkbox"/> | <input type="checkbox"/> | <input type="checkbox"/> | <input type="checkbox"/> | <input type="checkbox"/> |
| VLAN3 | <input type="checkbox"/> | <input type="checkbox"/> | <input type="checkbox"/> | <input type="checkbox"/> | <input type="checkbox"/> | <input type="checkbox"/> | <input type="checkbox"/> | <input type="checkbox"/> |
| VLAN4 | <input type="checkbox"/> | <input type="checkbox"/> | <input type="checkbox"/> | <input type="checkbox"/> | <input type="checkbox"/> | <input type="checkbox"/> | <input type="checkbox"/> | <input type="checkbox"/> |
| VLAN5 | <input type="checkbox"/> | <input type="checkbox"/> | <input type="checkbox"/> | <input type="checkbox"/> | <input type="checkbox"/> | <input type="checkbox"/> | <input type="checkbox"/> | <input type="checkbox"/> |
| VLAN6 | <input type="checkbox"/> | <input type="checkbox"/> | <input type="checkbox"/> | <input type="checkbox"/> | <input type="checkbox"/> | <input type="checkbox"/> | <input type="checkbox"/> | <input type="checkbox"/> |
| VLAN7 | <input type="checkbox"/> | <input type="checkbox"/> | <input type="checkbox"/> | <input type="checkbox"/> | <input type="checkbox"/> | <input type="checkbox"/> | <input type="checkbox"/> | <input type="checkbox"/> |

Note: Settings in this page only apply to LAN ports (not WAN ports).

Available settings are explained as follows:

| Item | Description |
|---------------------|------------------------------------------------------------------------------------|
| Enable | Click it to enable VLAN configuration. |
| LAN | P1 – P4 – Check the LAN port(s) to group them under the selected VLAN. |
| Wireless LAN | SSID1 – SSID4 – Check the SSID boxes to group them under the selected VLAN. |

Vigor2760 series features a flexible VLAN system. In its simplest form, each of the Gigabit LAN ports can be isolated from each other, for example to feed different companies or departments but keeping their local traffic completely separated.

To add or remove a VLAN, please refer to the following example.

1. If, VLAN 0 is consisted of hosts linked to P1 and P2 and VLAN 1 is consisted of hosts linked to P3 and P4.

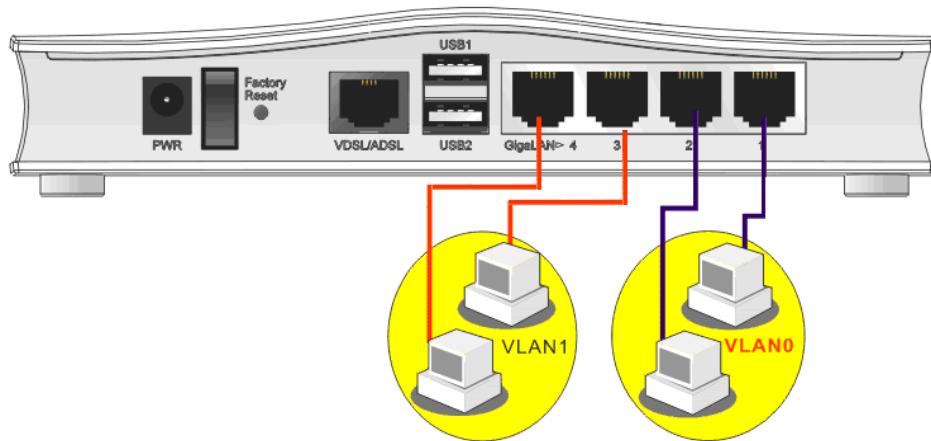

2. After checking the box to enable VLAN function, you will check the table according to the needs as shown below. Click **OK** to save the settings.

LAN >> VLAN Configuration

VLAN Configuration

| | LAN | | | | Wireless LAN | | | |
|--------------------------------------------|-------------------------------------|-------------------------------------|-------------------------------------|-------------------------------------|-------------------------------------|-------------------------------------|-------------------------------------|-------------------------------------|
| | P1 | P2 | P3 | P4 | SSID1 | SSID2 | SSID3 | SSID4 |
| <input checked="" type="checkbox"/> Enable | | | | | | | | |
| VLAN0 | <input checked="" type="checkbox"/> | <input checked="" type="checkbox"/> | <input type="checkbox"/> | <input type="checkbox"/> | <input checked="" type="checkbox"/> | <input checked="" type="checkbox"/> | <input checked="" type="checkbox"/> | <input checked="" type="checkbox"/> |
| VLAN1 | <input type="checkbox"/> | <input type="checkbox"/> | <input checked="" type="checkbox"/> | <input checked="" type="checkbox"/> | <input type="checkbox"/> | <input type="checkbox"/> | <input type="checkbox"/> | <input type="checkbox"/> |
| VLAN2 | <input type="checkbox"/> | <input type="checkbox"/> | <input type="checkbox"/> | <input type="checkbox"/> | <input type="checkbox"/> | <input type="checkbox"/> | <input type="checkbox"/> | <input type="checkbox"/> |
| VLAN3 | <input type="checkbox"/> | <input type="checkbox"/> | <input type="checkbox"/> | <input type="checkbox"/> | <input type="checkbox"/> | <input type="checkbox"/> | <input type="checkbox"/> | <input type="checkbox"/> |
| VLAN4 | <input type="checkbox"/> | <input type="checkbox"/> | <input type="checkbox"/> | <input type="checkbox"/> | <input type="checkbox"/> | <input type="checkbox"/> | <input type="checkbox"/> | <input type="checkbox"/> |
| VLAN5 | <input type="checkbox"/> | <input type="checkbox"/> | <input type="checkbox"/> | <input type="checkbox"/> | <input type="checkbox"/> | <input type="checkbox"/> | <input type="checkbox"/> | <input type="checkbox"/> |
| VLAN6 | <input type="checkbox"/> | <input type="checkbox"/> | <input type="checkbox"/> | <input type="checkbox"/> | <input type="checkbox"/> | <input type="checkbox"/> | <input type="checkbox"/> | <input type="checkbox"/> |
| VLAN7 | <input type="checkbox"/> | <input type="checkbox"/> | <input type="checkbox"/> | <input type="checkbox"/> | <input type="checkbox"/> | <input type="checkbox"/> | <input type="checkbox"/> | <input type="checkbox"/> |

3.2.4 LAN Port Mirror

LAN port mirror can be applied for the users in LAN. Generally speaking, this function copies traffic from one or more specific ports to a target port. This mechanism helps manager track the network errors or abnormal packets transmission without interrupting the flow of data access the network. By the way, user can apply this function to monitor all traffics which user needs to check.

There are some advantages supported in this feature. First, it is more economical without other detecting equipments to be set up. Second, it may be able to view traffic on one or more ports within a VLAN at the same time. Third, it can transfer all data traffics to be mirrored to one analyzer connect to the mirroring port. Last, it is more convenient and easy to configure in user's interface.

LAN >> LAN Port Mirror

LAN Port Mirror

Port Mirror:
 Enable Disable

Mirror port:
 P1 P2 P3 P4

Mirrored port:
 P1 P2 P3 P4

Available settings are explained as follows:

| Item | Description |
|----------------------|-------------------------------------------------------------------------------------------------|
| Port Mirror | Check Enable to activate this function. Or, check Disable to close this function. |
| Mirror Port | Select a port to view traffic sent from mirrored ports. |
| Mirrored Port | Select which ports are necessary to be mirrored. |

After finishing all the settings here, please click **OK** to save the configuration.

3.2.5 Web Portal Setup

This page allows you to configure a profile with specified URL for accessing into or display a message when a wireless/LAN user connects to Internet through this router. No matter what the purpose of the wireless/LAN client is, he/she will be forced into the URL configured here while trying to access into the Internet or the desired web page through this router. That is, a company which wants to have an advertisement for its products to users can specify the URL in this page to reach its goal.

LAN >> Web Portal Setup

Web Portal Table:

| Profile | Status | Interface | |
|--------------------|---------|-----------|----------------------------------------|
| 1. | Disable | None | <input type="button" value="Preview"/> |
| 2. | Disable | None | <input type="button" value="Preview"/> |
| 3. | Disable | None | <input type="button" value="Preview"/> |
| 4. | Disable | None | <input type="button" value="Preview"/> |

Note: Internet access must be enabled while webpage redirection is about to enable.

Each item is explained as follows:

| Item | Description |
|------------------|------------------------------------------------------------------------|
| Profile | Display the number link which allows you to configure the profile. |
| Status | Display the content (Disable, URL Redirect or Message) of the profile. |
| Interface | Display the applied interfaced of the profile. |
| Preview | Open a preview window according to the configured settings. |

To configure the profile, click any index number link to open the following page.

LAN >> Web Portal Setup

Profile Index: 1

Disable
 URL Redirect
 Message

(Max 511 characters)

Applied Interfaces

LAN1 LAN2
 SSID1 SSID2 SSID3 SSID4

2.4G SSID

Available settings are explained as follows:

| Item | Description |
|----------------|-------------------------------------------|
| Disable | Click this button to close this function. |

| | |
|---------------------------|----------------------------------------------------------------------------------------------------------------------------------------------------------------------------------------------------------------------------------------------------------------------------------------------------|
| URL Redirect | Any user who wants to access into Internet through this router will be redirected to the URL specified here first. It is a useful method for the purpose of advertisement. For example, force the wireless user(s) in hotel to access into the web page that the hotel wants the user(s) to visit. |
| Message | Type words or sentences here. The message will be displayed on the screen for several seconds when the wireless users access into the web page through the router. |
| Applied Interfaces | Check the box(es) representing different interfaces to be applied by such profile. The advantage is that each SSID (1/2/3/4) for wireless network can be applied with different web portal separately. |

After finishing all the settings here, please click **OK** to save the configuration.

3.3 NAT

Usually, the router serves as an NAT (Network Address Translation) router. NAT is a mechanism that one or more private IP addresses can be mapped into a single public one. Public IP address is usually assigned by your ISP, for which you may get charged. Private IP addresses are recognized only among internal hosts.

When the outgoing packets destined to some public server on the Internet reach the NAT router, the router will change its source address into the public IP address of the router, select the available public port, and then forward it. At the same time, the router shall list an entry in a table to memorize this address/port-mapping relationship. When the public server response, the incoming traffic, of course, is destined to the router's public IP address and the router will do the inversion based on its table. Therefore, the internal host can communicate with external host smoothly.

The benefit of the NAT includes:

- **Save cost on applying public IP address and apply efficient usage of IP address.** NAT allows the internal IP addresses of local hosts to be translated into one public IP address, thus you can have only one IP address on behalf of the entire internal hosts.
- **Enhance security of the internal network by obscuring the IP address.** There are many attacks aiming victims based on the IP address. Since the attacker cannot be aware of any private IP addresses, the NAT function can protect the internal network.

Note: On NAT page, you will see the private IP address defined in RFC-1918. Usually we use the 192.168.1.0/24 subnet for the router. As stated before, the NAT facility can map one or more IP addresses and/or service ports into different specified services. In other words, the NAT function can be achieved by using port mapping methods.

Below shows the menu items for NAT.



3.3.1 Port Redirection

Port Redirection is usually set up for server related service inside the local network (LAN), such as web servers, FTP servers, E-mail servers etc. Most of the case, you need a public IP address for each server and this public IP address/domain name are recognized by all users. Since the server is actually located inside the LAN, the network well protected by NAT of the router, and identified by its private IP address/port, the goal of Port Redirection function is to forward all access request with public IP address from external users to the mapping private IP address/port of the server.

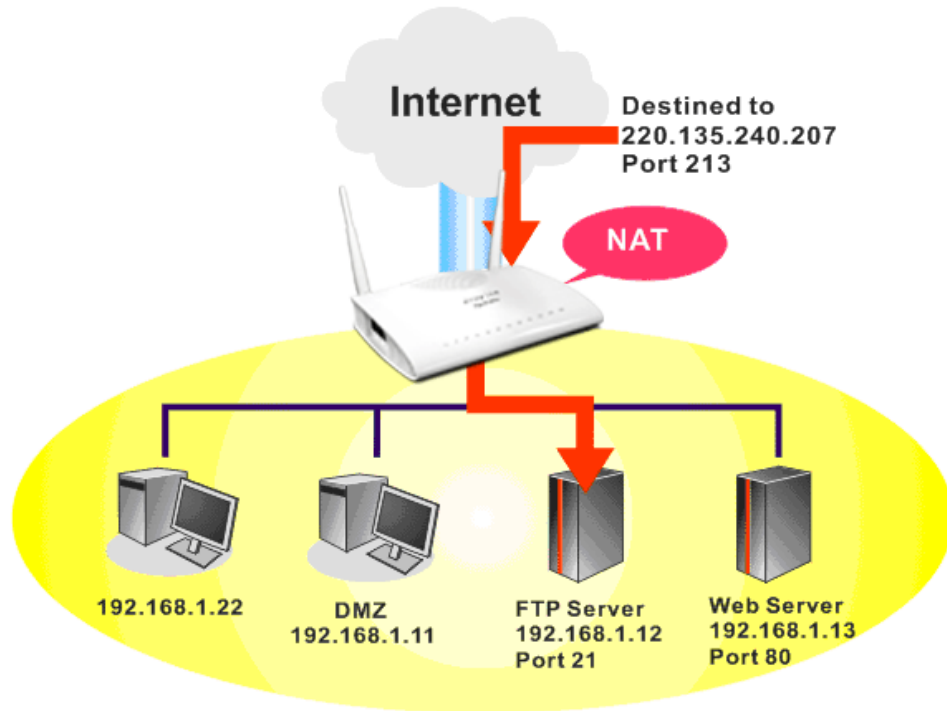

The port redirection can only apply to incoming traffic.

To use this function, please go to **NAT** page and choose **Port Redirection** web page. The **Port Redirection Table** provides 40 port-mapping entries for the internal hosts.

NAT >> Port Redirection

| Port Redirection | | | | | | Set to Factory Default |
|------------------|--------------|---------------|----------|-------------|------------|----------------------------------------|
| Index | Service Name | WAN Interface | Protocol | Public Port | Private IP | Status |
| <u>1.</u> | | All | | | | x |
| <u>2.</u> | | All | | | | x |
| <u>3.</u> | | All | | | | x |
| <u>4.</u> | | All | | | | x |
| <u>5.</u> | | All | | | | x |
| <u>6.</u> | | All | | | | x |
| <u>7.</u> | | All | | | | x |
| <u>8.</u> | | All | | | | x |
| <u>9.</u> | | All | | | | x |
| <u>10.</u> | | All | | | | x |

<< [1-10](#) | [11-20](#) | [21-30](#) | [31-40](#) >>

[Next](#) >>

Note:The configured ports in the **Management** and **SSL VPN** webUIs will be used by the router and not be sent to the local computer defined here.

Each item is explained as follows:

| Item | Description |
|----------------------|--------------------------------------------------------------------------------------------------------------------|
| Index | Display the number of the profile. |
| Service Name | Display the description of the specific network service. |
| WAN Interface | Display the WAN IP address used by the profile. |
| Protocol | Display the transport layer protocol (TCP or UDP). |
| Public Port | Display the port number which will be redirected to the specified Private IP and Port of the internal host. |
| Private IP | Display the IP address of the internal host providing the service. |
| Status | Display if the profile is enabled (v) or not (x). |

Press any number under Index to access into next page for configuring port redirection.

NAT >> Port Redirection

Index No. 1

Enable

Mode Range ▾

Service Name Single

Protocol Range

WAN IP --- ▾

Public Port 1.All ▾

Private IP 0 -

Private Port -

Private Port 0

Note: In "Range" Mode the End IP will be calculated automatically once the Public Port and Start IP have been entered.

Available settings are explained as follows:

| Item | Description |
|---------------------|-------------------------------------------------------------------------------------------------------------------------------------------------------------------------------------------------------------------------------------------------------------------------------------------------------------------------------------|
| Enable | Check this box to enable such port redirection setting. |
| Mode | Two options (Single and Range) are provided here for you to choose. To set a range for the specific service, select Range . In Range mode, if the public port (start port and end port) and the starting IP of private IP had been entered, the system will calculate and display the ending IP of private IP automatically. |
| Service Name | Enter the description of the specific network service. |
| Protocol | Select the transport layer protocol (TCP or UDP). |

| | |
|---------------------|--------------------------------------------------------------------------------------------------------------------------------------------------------------------------------------------------------------------------------------------------------------------------------------------------------------|
| WAN IP | Select the WAN IP used for port redirection. The default setting is All which means all the incoming data from any port will be redirected to specified range of IP address and port. |
| Public Port | Specify which port can be redirected to the specified Private IP and Port of the internal host. If you choose Range as the port redirection mode, you will see two boxes on this field. Simply type the required number on the first box. The second one will be assigned automatically later. |
| Private IP | Specify the private IP address of the internal host providing the service. If you choose Range as the port redirection mode, you will see two boxes on this field. Type a complete IP address in the first box (as the starting point) and the fourth digits in the second box (as the end point). |
| Private Port | Specify the private port number of the service offered by the internal host. |

After finishing all the settings here, please click **OK** to save the configuration.

Note that the router has its own built-in services (servers) such as Telnet, HTTP and FTP etc. Since the common port numbers of these services (servers) are all the same, you may need to reset the router in order to avoid confliction.

For example, the built-in web user interface in the router is with default port 80, which may conflict with the web server in the local network, <http://192.168.1.13:80>. Therefore, you need to **change the router's http port to any one other than the default port 80** to avoid conflict, such as 8080. This can be set in the **System Maintenance >>Management Setup**. You then will access the admin screen of by suffixing the IP address with 8080, e.g., <http://192.168.1.1:8080> instead of port 80.

| IPv4 Management Setup | IPv6 Management Setup | | | | | | | | | | | | |
|----------------------------------------------------------------------------------------------------------------------------------------------------------------------------------------------------------------------------------------------------------------------------------------------------------------------------------------------------------------------------------------------------------------------------------------------------------------------------------------------------------------------------------------------------------------------------------------------------------------------------------------------------------------------------------------------------------------------------------------------------------------------------------------------------------------------------------------------------------------------------------------------------------------------------------------------------------------------------------------------------------------------------------------------------------------------------------------------------------------------------------------------------------------------------------------------------------------------------------------------------------------------------------------------------------------------------------------------------------------------------------------------------------------------------|-----------------------|----------------------|-------------|---|----------------------|----------------------|---|----------------------|----------------------|---|----------------------|----------------------|-----------------------------------------------------------------------------------------------------------------------------------------------------------------------------------------------------------------------------------------------------------------------------------------------------------------------------------------------------------------------------------------------------------------------------------------------------------------------------------------------------------------------------------------------------------------------------------------------------------------|
| Router Name <input type="text"/> <input type="checkbox"/> Default:Disable Auto-Logout <hr/> Internet Access Control <input checked="" type="checkbox"/> Allow management from the Internet <input type="checkbox"/> FTP Server <input checked="" type="checkbox"/> HTTP Server <input checked="" type="checkbox"/> HTTPS Server <input checked="" type="checkbox"/> Telnet Server <input type="checkbox"/> TR069 Server <input type="checkbox"/> SSH Server <input type="checkbox"/> Disable PING from the Internet <hr/> LAN Access Control <input checked="" type="checkbox"/> Allow management from LAN <input checked="" type="checkbox"/> FTP Server <input checked="" type="checkbox"/> HTTP Server <input checked="" type="checkbox"/> HTTPS Server <input checked="" type="checkbox"/> Telnet Server <input checked="" type="checkbox"/> SSH Server Apply To <input checked="" type="checkbox"/> LAN2 <hr/> Access List from the Internet <table border="1"> <thead> <tr> <th>List</th> <th>IP</th> <th>Subnet Mask</th> </tr> </thead> <tbody> <tr> <td>1</td> <td><input type="text"/></td> <td><input type="text"/></td> </tr> <tr> <td>2</td> <td><input type="text"/></td> <td><input type="text"/></td> </tr> <tr> <td>3</td> <td><input type="text"/></td> <td><input type="text"/></td> </tr> </tbody> </table> | List | IP | Subnet Mask | 1 | <input type="text"/> | <input type="text"/> | 2 | <input type="text"/> | <input type="text"/> | 3 | <input type="text"/> | <input type="text"/> | Management Port Setup <input checked="" type="radio"/> User Define Ports <input type="radio"/> Default Ports Telnet Port <input type="text" value="23"/> (Default: 23) HTTP Port <input type="text" value="8276"/> (Default: 80) HTTPS Port <input type="text" value="443"/> (Default: 443) FTP Port <input type="text" value="21"/> (Default: 21) TR069 Port <input type="text" value="8069"/> (Default: 8069) SSH Port <input type="text" value="22"/> (Default: 22) <hr/> External Device Control <input checked="" type="checkbox"/> No respond to External Device |
| List | IP | Subnet Mask | | | | | | | | | | | |
| 1 | <input type="text"/> | <input type="text"/> | | | | | | | | | | | |
| 2 | <input type="text"/> | <input type="text"/> | | | | | | | | | | | |
| 3 | <input type="text"/> | <input type="text"/> | | | | | | | | | | | |

Note: LAN1 is always allowed to access all the router services regardless of "LAN Access Control" settings.

OK

3.3.2 DMZ Host

As mentioned above, **Port Redirection** can redirect incoming TCP/UDP or other traffic on particular ports to the specific private IP address/port of host in the LAN. However, other IP protocols, for example Protocols 50 (ESP) and 51 (AH), do not travel on a fixed port. Vigor router provides a facility **DMZ Host** that maps ALL unsolicited data on any protocol to a single host in the LAN. Regular web surfing and other such Internet activities from other clients will continue to work without inappropriate interruption. **DMZ Host** allows a defined internal user to be totally exposed to the Internet, which usually helps some special applications such as Netmeeting or Internet Games etc.

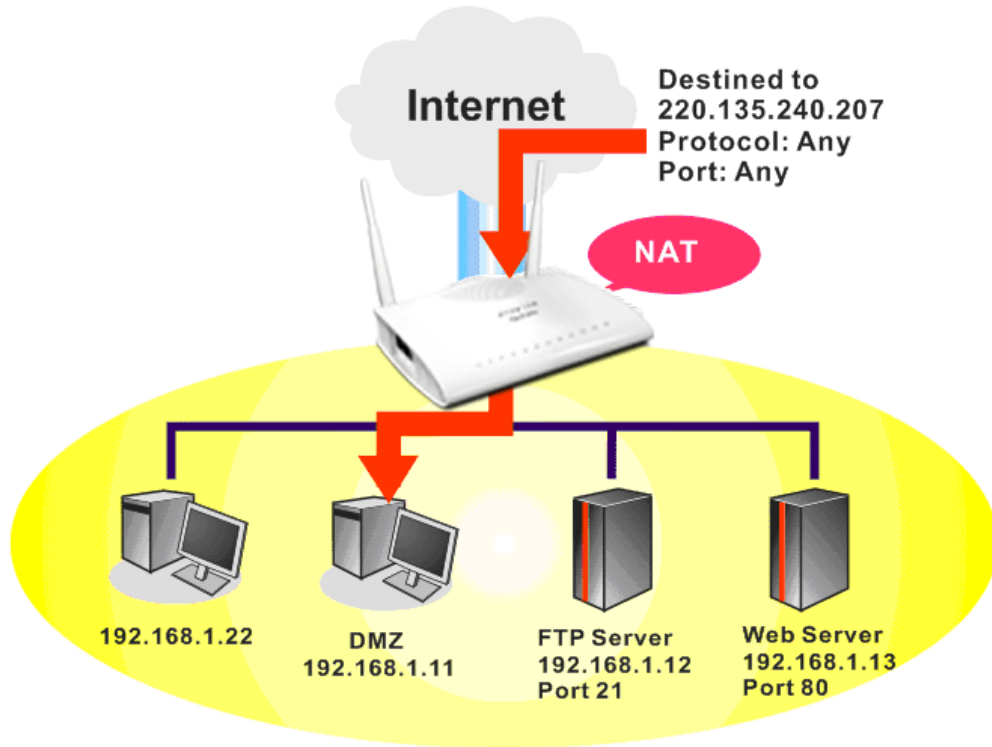

The security properties of NAT are somewhat bypassed if you set up DMZ host. We suggest you to add additional filter rules or a secondary firewall.

Click **DMZ Host** to open the following page. You can set different DMZ host for each WAN interface. Click the WAN tab to switch into the configuration page for that WAN.

NAT >> DMZ Host Setup

DMZ Host Setup

| WAN1 | WAN2 | WAN3 |
|---------------------------------------------------------------------------------------------------------------------------------------------------------------------------------------------------------------------------------------------------------------------------------------------------------------------------------------------------------------------------------------------------------------------------------------------------------------------------------------------------------------------------------------------------|------|------|
| <p>WAN 1</p> <p>None <input type="button" value="v"/></p> <p>Private IP <input type="text" value=""/> <input type="button" value="Choose IP"/></p> <p>MAC Address of the True IP DMZ Host <input type="text" value="00"/> · <input type="text" value="00"/> · <input type="text" value="00"/> : <input type="text" value="00"/> · <input type="text" value="00"/> · <input type="text" value="00"/></p> <p>Note: When a True-IP DMZ host is turned on, it will force the router's WAN connection to be always on.</p> | | |

Available settings are explained as follows:

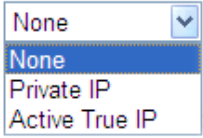
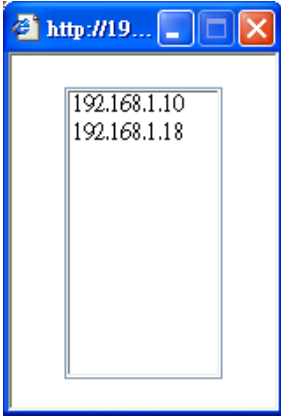
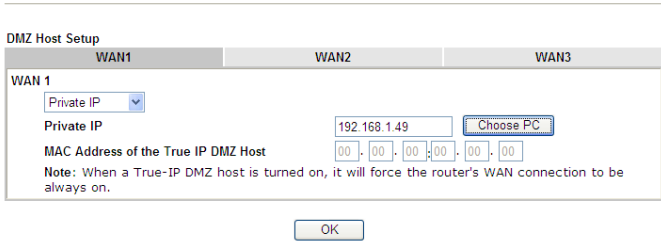
| Item | Description |
|-------------------------------------------------------------------------------------------------------|--------------------------------------------------------------------------------------------------------------------------------------------------------------------------------------------------------------------------------------------------------------------------------------------------------------------------------------------------------------------------------------------------------------------------------------------------------------------------------------------------------------------------------------------------------------------------------------------------------------------------|
| <p>WAN 1</p>  | <p>Choose Private IP or Active True IP first. Active True IP selection is available for WAN1 only.</p> |
| <p>Private IP</p> | <p>Enter the private IP address of the DMZ host, or click Choose PC to select one.</p> |
| <p>Choose PC</p> | <p>Click this button and then a window will automatically pop up, as depicted below. The window consists of a list of private IP addresses of all hosts in your LAN network. Select one private IP address in the list to be the DMZ host.</p>  <p>When you have selected one private IP from the above dialog, the IP address will be shown on the following screen. Click OK to save the setting.</p> <p>NAT >> DMZ Host Setup</p>  |

DMZ Host for WAN2 or WAN3 is slightly different with WAN1. **Active True IP** selection is available for WAN1 only.

See the following figure.

NAT >> DMZ Host Setup

DMZ Host Setup

| WAN1 | WAN2 | WAN3 |
|-------------------------------------------------------------------|----------------------------------------------------------|------|
| <p>WAN 2</p> <p>Enable</p> <p><input type="checkbox"/></p> | <p>Private IP</p> <p>0.0.0.0</p> <p>Choose IP</p> | |

OK

NAT >> DMZ Host Setup

DMZ Host Setup

| WAN1 | | WAN2 | | WAN3 | |
|--------------|--------------------------|-------------|--------------------------------------|------------------------------------------|--|
| WAN 2 | | | | | |
| Index | Enable | Aux. WAN IP | Private IP | | |
| 1. | <input type="checkbox"/> | 10.39.0.10 | <input type="text" value="0.0.0.0"/> | <input type="button" value="Choose IP"/> | |
| 2. | <input type="checkbox"/> | 10.39.0.150 | <input type="text" value="0.0.0.0"/> | <input type="button" value="Choose IP"/> | |

Available settings are explained as follows:

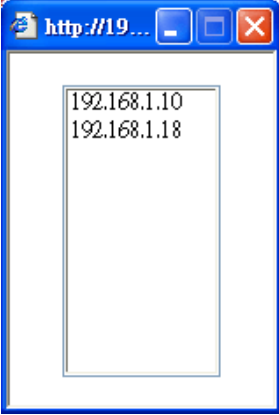
| Item | Description |
|-------------------|-----------------------------------------------------------------------------------------------------------------------------------------------------------------------------------------------------------------------------------------------------------------------------------------------------------------------------------------------------------------------------------------------------------------------------------------------------------------------------------------|
| Enable | Check to enable the DMZ Host function. |
| Private IP | Enter the private IP address of the DMZ host, or click Choose PC to select one. |
| Choose PC | <p>Click this button and then a window will automatically pop up, as depicted below. The window consists of a list of private IP addresses of all hosts in your LAN network. Select one private IP address in the list to be the DMZ host.</p>  <p>When you have selected one private IP from the above dialog, the IP address will be shown on the screen. Click OK to save the setting.</p> |

After finishing all the settings here, please click **OK** to save the configuration.

3.3.3 Open Ports

Open Ports allows you to open a range of ports for the traffic of special applications.

Common application of Open Ports includes P2P application (e.g., BT, KaZaA, Gnutella, WinMX, eMule and others), Internet Camera etc. Ensure that you keep the application involved up-to-date to avoid falling victim to any security exploits.

Click **Open Ports** to open the following page:

NAT >> Open Ports

| Open Ports Setup | | | Set to Factory Default |
|---------------------|---------|------------------|----------------------------------------|
| Index | Comment | Local IP Address | Status |
| 1. | | | X |
| 2. | | | X |
| 3. | | | X |
| 4. | | | X |
| 5. | | | X |
| 6. | | | X |
| 7. | | | X |
| 8. | | | X |
| 9. | | | X |
| 10. | | | X |

<< [1-10](#) | [11-20](#) | [21-30](#) | [31-40](#) >>

[Next](#) >>

Note:The configured ports in the **Management** webUIs will be used by the router and not be sent to the local computer defined here.

Available settings are explained as follows:

| Item | Description |
|-------------------------|-----------------------------------------------------------------------------------------------------------------------------------------------------------------------------------------------|
| Index | Indicate the relative number for the particular entry that you want to offer service in a local host. You should click the appropriate index number to edit or clear the corresponding entry. |
| Comment | Specify the name for the defined network service. |
| Local IP Address | Display the private IP address of the local host offering the service. |
| Status | Display the state for the corresponding entry. X or V is to represent the Inactive or Active state. |

To add or edit port settings, click one index number on the page. The index entry setup page will pop up. In each index entry, you can specify **10** port ranges for diverse services.

NAT >> Open Ports >> Edit Open Ports

Index No. 1

| | | | | | | | |
|-------------------------------------------------------|----------|-----------------------------------------|------------------------------------------|-----|----------|--------------------------------|--------------------------------|
| <input checked="" type="checkbox"/> Enable Open Ports | | | | | | | |
| Comment | | <input type="text" value="P226"/> | | | | | |
| Private IP | | <input type="text" value="10.39.0.11"/> | <input type="button" value="Choose IP"/> | | | | |
| | Protocol | Start Port | End Port | | Protocol | Start Port | End Port |
| 1. | TCP | <input type="text" value="80"/> | <input type="text" value="80"/> | 2. | ----- | <input type="text" value="0"/> | <input type="text" value="0"/> |
| 3. | ----- | <input type="text" value="0"/> | <input type="text" value="0"/> | 4. | ----- | <input type="text" value="0"/> | <input type="text" value="0"/> |
| 5. | ----- | <input type="text" value="0"/> | <input type="text" value="0"/> | 6. | ----- | <input type="text" value="0"/> | <input type="text" value="0"/> |
| 7. | ----- | <input type="text" value="0"/> | <input type="text" value="0"/> | 8. | ----- | <input type="text" value="0"/> | <input type="text" value="0"/> |
| 9. | ----- | <input type="text" value="0"/> | <input type="text" value="0"/> | 10. | ----- | <input type="text" value="0"/> | <input type="text" value="0"/> |

Available settings are explained as follows:

| Item | Description |
|--------------------------|--------------------------------------------------------------------------------------------------------------------------------------------------------------------------------------------------------------------------------------------------------------------------------------------------------------|
| Enable Open Ports | Check to enable this entry. |
| Comment | Make a name for the defined network application/service. |
| Private IP | Enter the private IP address of the local host or click Choose PC to select one. Choose PC - Click this button and, subsequently, a window having a list of private IP addresses of local hosts will automatically pop up. Select the appropriate IP address of the local host in the list. |
| Protocol | Specify the transport layer protocol. It could be TCP , UDP , or ----- (none) for selection. |
| Start Port | Specify the starting port number of the service offered by the local host. |
| End Port | Specify the ending port number of the service offered by the local host. |

After finishing all the settings here, please click **OK** to save the configuration.

NAT >> Open Ports

| Open Ports Setup | | | Set to Factory Default |
|------------------|---------|------------------|------------------------|
| Index | Comment | Local IP Address | Status |
| <u>1.</u> | P226 | 10.39.0.11 | √ |
| <u>2.</u> | | | × |
| <u>3.</u> | | | × |
| <u>4.</u> | | | × |
| <u>5.</u> | | | × |
| <u>6.</u> | | | × |
| <u>7.</u> | | | × |
| <u>8.</u> | | | × |
| <u>9.</u> | | | × |
| <u>10.</u> | | | × |

<< [1-10](#) | [11-20](#) | [21-30](#) | [31-40](#) >> [Next](#) >>

Note:The configured ports in the **Management** webUIs will be used by the router and not be sent to the local computer defined here.

3.3.4 Port Triggering

Port Triggering is a variation of open ports function.

The key difference between "open port" and "port triggering" is:

- Once the OK button is clicked and the configuration has taken effect, "open port" keeps the ports opened forever.
- Once the OK button is clicked and the configuration has taken effect, "port triggering" will only attempt to open the ports once the triggering conditions are met.
- The duration that these ports are opened depends on the type of protocol used. The "default" durations are shown below and these duration values can be modified via telnet commands.

TCP: 86400 sec.

UDP: 180 sec.

IGMP: 10 sec.

TCP WWW: 60 sec.

TCP SYN: 60 sec.

NAT >> Port Triggering

| Port Triggering | | | | | | Set to Factory Default |
|-----------------|---------|---------------------|-----------------|-------------------|---------------|------------------------|
| Index | Comment | Triggering Protocol | Triggering Port | Incoming Protocol | Incoming Port | Status |
| <u>1.</u> | | | | | | × |
| <u>2.</u> | | | | | | × |
| <u>3.</u> | | | | | | × |
| <u>4.</u> | | | | | | × |
| <u>5.</u> | | | | | | × |
| <u>6.</u> | | | | | | × |
| <u>7.</u> | | | | | | × |
| <u>8.</u> | | | | | | × |
| <u>9.</u> | | | | | | × |
| <u>10.</u> | | | | | | × |

<< [1-10](#) | [11-20](#) >> [Next](#) >>

Available settings are explained as follows:

| Item | Description |
|----------------------------|------------------------------------------------------------------------|
| Comment | Display the text which memorizes the application of this rule. |
| Triggering Protocol | Display the protocol of the triggering packets. |
| Triggering Port | Display the port of the triggering packets. |
| Incoming Protocol | Display the protocol for the incoming data of such triggering profile. |
| Incoming Port | Display the port for the incoming data of such triggering profile. |
| Status | Display if the rule is active or de-active. |

Click the index number link to open the configuration page.

NAT >> Port Triggering

No. 1

Enable

Service User Defined ▾

Comment

Triggering Protocol TCP ▾

Triggering Port



Incoming Protocol UDP ▾

Incoming Port

Note: The Triggering Port and Incoming Port should be input like this :
123-456,777-789 (legal),123-456,789 (legal), but 123-456-789 (illegal).

Available settings are explained as follows:

| Item | Description |
|----------------|------------------------------------------------------------------------------------------------------------------------------------------------------------------------------------------------------------------------------------------------------------------------------------------------|
| Enable | Check to enable this entry. |
| Service | Choose the predefined service to apply for such trigger profile. <div style="border: 1px solid black; padding: 2px; margin-top: 5px;"> User Defined ▾ User Defined Real Player QuickTime WMP IRC AIM Talk ICQ PaITalk BitTorrent </div> |
| Comment | Type the text to memorize the application of this rule. |

| | |
|----------------------------|------------------------------------------------------------------------------------------------------------------------------------------------------------------------------------------------------------------------------------------------------------------------------------------------|
| Triggering Protocol | <p>Select the protocol (TCP, UDP or TCP/UDP) for such triggering profile.</p>  |
| Triggering Port | <p>Type the port or port range for such triggering profile.</p> |
| Incoming Protocol | <p>When the triggering packets received, it is expected the incoming packets will use the selected protocol. Select the protocol (TCP, UDP or TCP/UDP) for the incoming data of such triggering profile.</p>  |
| Incoming Port | <p>Type the port or port range for the incoming packets.</p> |

After finishing all the settings here, please click **OK** to save the configuration.

3.4 Firewall

3.4.1 Basics for Firewall

While the broadband users demand more bandwidth for multimedia, interactive applications, or distance learning, security has been always the most concerned. The firewall of the Vigor router helps to protect your local network against attack from unauthorized outsiders. It also restricts users in the local network from accessing the Internet. Furthermore, it can filter out specific packets that trigger the router to build an unwanted outgoing connection.

Firewall Facilities

The users on the LAN are provided with secured protection by the following firewall facilities:

- User-configurable IP filter (Call Filter/ Data Filter).
- Stateful Packet Inspection (SPI): tracks packets and denies unsolicited incoming data
- Selectable Denial of Service (DoS) /Distributed DoS (DDoS) attacks protection

IP Filters

Depending on whether there is an existing Internet connection, or in other words “the WAN link status is up or down”, the IP filter architecture categorizes traffic into two: **Call Filter** and **Data Filter**.

- **Call Filter** - When there is no existing Internet connection, **Call Filter** is applied to all traffic, all of which should be outgoing. It will check packets according to the filter rules. If legal, the packet will pass. Then the router shall “**initiate a call**” to build the Internet connection and send the packet to Internet.
- **Data Filter** - When there is an existing Internet connection, **Data Filter** is applied to incoming and outgoing traffic. It will check packets according to the filter rules. If legal, the packet will pass the router.

The following illustrations are flow charts explaining how router will treat incoming traffic and outgoing traffic respectively.

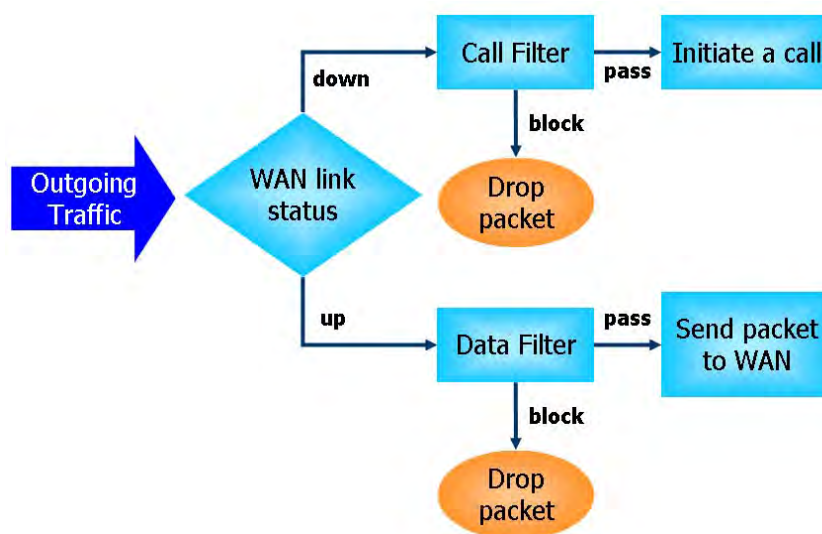

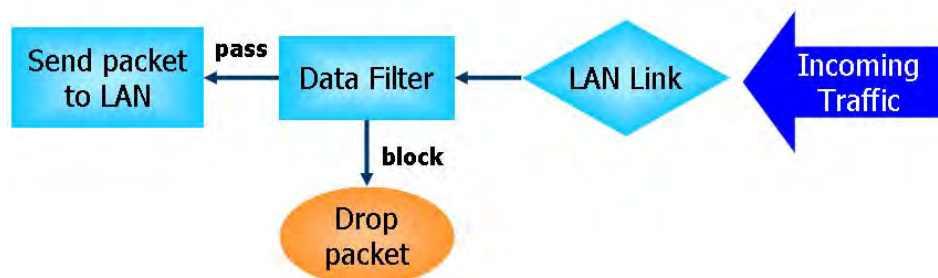

Stateful Packet Inspection (SPI)

Stateful inspection is a firewall architecture that works at the network layer. Unlike legacy static packet filtering, which examines a packet based on the information in its header, stateful inspection builds up a state machine to track each connection traversing all interfaces of the firewall and makes sure they are valid. The stateful firewall of Vigor router not just examine the header information also monitor the state of the connection.

Denial of Service (DoS) Defense

The **DoS Defense** functionality helps you to detect and mitigate the DoS attack. The attacks are usually categorized into two types, the flooding-type attacks and the vulnerability attacks. The flooding-type attacks will attempt to exhaust all your system's resource while the vulnerability attacks will try to paralyze the system by offending the vulnerabilities of the protocol or operation system.

The **DoS Defense** function enables the Vigor router to inspect every incoming packet based on the attack signature database. Any malicious packet that might duplicate itself to paralyze the host in the secure LAN will be strictly blocked and a Syslog message will be sent as warning, if you set up Syslog server.

Also the Vigor router monitors the traffic. Any abnormal traffic flow violating the pre-defined parameter, such as the number of thresholds, is identified as an attack and the Vigor router will activate its defense mechanism to mitigate in a real-time manner.

The below shows the attack types that DoS/DDoS defense function can detect:

- | | |
|----------------------|--------------------------|
| 1. SYN flood attack | 9. SYN fragment |
| 2. UDP flood attack | 10. Fraggle attack |
| 3. ICMP flood attack | 11. TCP flag scan |
| 4. Port Scan attack | 12. Tear drop attack |
| 5. IP options | 13. Ping of Death attack |
| 6. Land attack | 14. ICMP fragment |
| 7. Smurf attack | 15. Unassigned Numbers |
| 8. Trace route | |

Below shows the menu items for Firewall.

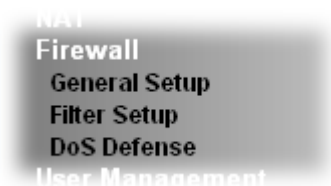

3.4.2 General Setup

General Setup allows you to adjust settings of IP Filter and common options. Here you can enable or disable the **Call Filter** or **Data Filter**. Under some circumstance, your filter set can be linked to work in a serial manner. So here you assign the **Start Filter Set** only. Also you can configure the **Log Flag** settings, **Apply IP filter to VPN incoming packets**, and **Accept incoming fragmented UDP packets**.

Click **Firewall** and click **General Setup** to open the general setup page.

General Setup Page

Such page allows you to enable / disable Call Filter and Data Filter, determine general rule for filtering the incoming and outgoing data.

Firewall >> General Setup

General Setup

General Setup
Default Rule

Call Filter Enable Start Filter Set

Disable

Data Filter Enable Start Filter Set

Disable

Accept large incoming fragmented UDP or ICMP packets (for some games, ex. CS)

Enable Strict Security Firewall

Accept routing packet from WAN

IPv4 IPv6

Note: The packets will be filtered with the follow function sequentially:

1. Accept Routing Packet from WAN
2. Data Filter Set and Rule in Firewall
3. Default Rule in Firewall

Available settings are explained as follows:

| Item | Description |
|--------------------|----------------------------------------------------------------------------------------------------------|
| Call Filter | Check Enable to activate the Call Filter function. Assign a start filter set for the Call Filter. |
| Data Filter | Check Enable to activate the Data Filter function. Assign a start filter set for the Data Filter. |

| | |
|----------------------------------------|----------------------------------------------------------------------------------------------------------------------------------------------------------------------------------------------------------------------------------------------------------------------------------------------------------------------------------------------------------------------------------------------------------------------------------------------------------------------------------------------------------------------------------------------------------|
| Accept large incoming... | Some on-line games (for example: Half Life) will use lots of fragmented UDP packets to transfer game data. Instinctively as a secure firewall, Vigor router will reject these fragmented packets to prevent attack unless you enable “ Accept large incoming fragmented UDP or ICMP Packets ”. By checking this box, you can play these kinds of on-line games. If security concern is in higher priority, you cannot enable “ Accept large incoming fragmented UDP or ICMP Packets ”. |
| Enable Strict Security Firewall | For the sake of security, the router will execute strict security checking for data transmission. Such feature is enabled in default. All the packets, while transmitting through Vigor router, will be filtered by firewall. If the firewall system (e.g., content filter server) does not make any response (pass or block) for these packets, then the router’s firewall will block the packets directly. |
| Accept routing packet from WAN | Usually, IPv6 network sessions/traffic from WAN to LAN will be blocked by IPv6 firewall to prevent remote client accessing into the PCs on LAN in default. IPv6 - Check the box to make the packets (routed from WAN to LAN) via IPv6 being accepted by such router. It is effective only for the packets routed but not for packets translated by NAT. IPv4 - Check the box to make the incoming packets via IPv4 being accepted by such router. It is effective only for the packets routed but not for packets translated by NAT. |

Default Rule Page

Such page allows you to choose filtering profiles including QoS, Load-Balance policy, WCF, APP Enforcement, URL Content Filter, for data transmission via Vigor router.

Firewall >> General Setup

General Setup

| General Setup | Default Rule |
|----------------------------------|--------------------------------------------|
| Actions for default rule: | |
| Application | Action/Profile |
| Filter | Pass <input type="button" value="v"/> |
| Sessions Control | 0 / 32000 <input type="button" value="v"/> |
| Quality of Service | None <input type="button" value="v"/> |
| APP Enforcement | None <input type="button" value="v"/> |
| URL Content Filter | None <input type="button" value="v"/> |
| Web Content Filter | None <input type="button" value="v"/> |
| Syslog | <input type="checkbox"/> |
| Advance Setting | <input type="button" value="Edit"/> |

Available settings are explained as follows:

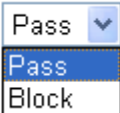
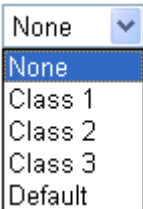
| Item | Description |
|---------------------------|----------------------------------------------------------------------------------------------------------------------------------------------------------------------------------------------------------------------------------------------------------------------------------------------------------------------------------------------------------------------------------------------------------------------------------------------------------------------------------------------------------------------------------------------------------------------------------------------------------------------------------------------------------------|
| Filter | <p>Select Pass or Block for the packets that do not match with the filter rules.</p> <p>Filter </p> |
| Sessions Control | <p>The number typed here is the total sessions of the packets that do not match the filter rule configured in this page. The default setting is 60000.</p> |
| Quality of Service | <p>Choose one of the QoS rules to be applied as firewall rule. For detailed information of setting QoS, please refer to the related section later.</p>  |
| APP Enforcement | <p>Select an APP Enforcement profile for global IM/P2P application blocking. If there is no profile for you to select, please choose [Create New] from the drop down list in this page to create a new profile. All the hosts in LAN must follow the standard configured in the APP Enforcement profile selected here. For detailed information, refer to the section of APP Enforcement profile setup. For troubleshooting needs, you can specify to record information for IM/P2P by checking the Log box. It will be sent to Syslog server. Please refer to section Syslog/Mail Alert for more detailed information.</p> |
| URL Content Filter | <p>Select one of the URL Content Filter profile settings (created in CSM>> URL Content Filter) for applying with this router. Please set at least one profile for choosing in CSM>> URL Content Filter web page first. Or choose [Create New] from the drop down list in this page to create a new profile. For troubleshooting needs, you can specify to record information for URL Content Filter by checking the Log box. It will be sent to Syslog server. Please refer to section Syslog/Mail Alert for more detailed information.</p> |
| Web Content Filter | <p>Select one of the Web Content Filter profile settings (created in CSM>> Web Content Filter) for applying with this router. Please set at least one profile for anti-virus in CSM>> Web Content Filter web page first. Or choose [Create New] from the drop down list in this page to create a new profile. For troubleshooting needs, you can specify to record information for Web Content Filter by checking the Log box. It will be sent to Syslog server. Please refer to section Syslog/Mail Alert for more detailed information.</p> |
| Advance Setting | <p>Click Edit to open the following window. However, it is</p> |

strongly recommended to use the default settings here.

Firewall >> General Setup

Advance Setting

| | |
|------------------|--------------------|
| Codepage | ANSI(1252)-Latin I |
| Window size: | 65535 |
| Session timeout: | 1440 Minute |

OK Close

Codepage - This function is used to compare the characters among different languages. Choose correct codepage can help the system obtaining correct ASCII after decoding data from URL and enhance the correctness of URL Content Filter. The default value for this setting is ANSI 1252 Latin I. If you do not choose any codepage, no decoding job of URL will be processed. Please use the drop-down list to choose a codepage.

If you do not have any idea of choosing suitable codepage, please open Syslog. From Codepage Information of Setup dialog, you will see the recommended codepage listed on the dialog box.

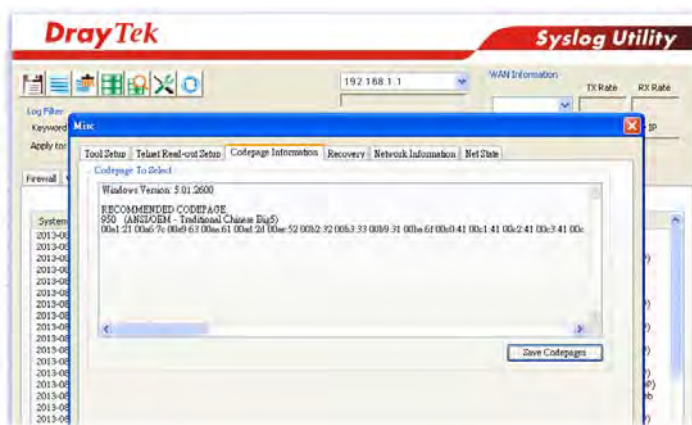

Window size – It determines the size of TCP protocol (0~65535). The more the value is, the better the performance will be. However, if the network is not stable, small value will be proper.

Session timeout – Setting timeout for sessions can make the best utilization of network resources.

After finishing all the settings here, please click **OK** to save the configuration.

3.4.3 Filter Setup

Click **Firewall** and click **Filter Setup** to open the setup page.

Firewall >> Filter Setup

| Filter Setup | | Set to Factory Default | |
|--------------------|---------------------|----------------------------------------|----------|
| Set | Comments | Set | Comments |
| 1. | Default Call Filter | 7. | |
| 2. | Default Data Filter | 8. | |
| 3. | | 9. | |
| 4. | | 10. | |
| 5. | | 11. | |
| 6. | | 12. | |

To edit or add a filter, click on the set number to edit the individual set. The following page will be shown. Each filter set contains up to 7 rules. Click on the rule number button to edit each rule. Check **Active** to enable the rule.

Firewall >> Filter Setup >> Edit Filter Set

Filter Set 1

Comments :

| Filter Rule | Active | Comments | Move Up | Move Down |
|----------------------------------|-------------------------------------|---------------|--------------------|----------------------|
| <input type="button" value="1"/> | <input checked="" type="checkbox"/> | Block NetBios | | Down |
| <input type="button" value="2"/> | <input type="checkbox"/> | | UP | Down |
| <input type="button" value="3"/> | <input type="checkbox"/> | | UP | Down |
| <input type="button" value="4"/> | <input type="checkbox"/> | | UP | Down |
| <input type="button" value="5"/> | <input type="checkbox"/> | | UP | Down |
| <input type="button" value="6"/> | <input type="checkbox"/> | | UP | Down |
| <input type="button" value="7"/> | <input type="checkbox"/> | | UP | |

Next Filter Set

Available settings are explained as follows:

| Item | Description |
|------------------------|---------------------------------------------------------------------------------------------------------------------------------------------------------------------------|
| Filter Rule | Click a button numbered (1 ~ 7) to edit the filter rule. Click the button will open Edit Filter Rule web page. For the detailed information, refer to the following page. |
| Active | Enable or disable the filter rule. |
| Comment | Enter filter set comments/description. Maximum length is 23-character long. |
| Move Up/Down | Use Up or Down link to move the order of the filter rules. |
| Next Filter Set | Set the link to the next filter set to be executed after the current filter run. Do not make a loop with many filter sets. |

To edit **Filter Rule**, click the **Filter Rule** index button to enter the **Filter Rule** setup page.

Filter Set 1 Rule 1

Check to enable the Filter Rule

Comments:

Index(1-15) in **Schedule** Setup: , , ,

Clear sessions when schedule ON: Enable

Direction:

Source IP:

Destination IP:

Service Type:

Fragments:

| Application | Action/Profile | Syslog |
|-----------------------------|------------------------------------------------|--------------------------|
| Filter: | <input type="text" value="Block Immediately"/> | <input type="checkbox"/> |
| Branch to Other Filter Set: | <input type="text" value="None"/> | |
| Sessions Control | 0 / <input type="text" value="32000"/> | <input type="checkbox"/> |
| MAC Bind IP | <input type="text" value="Non-Strict"/> | <input type="checkbox"/> |
| Quality of Service | <input type="text" value="None"/> | <input type="checkbox"/> |
| APP Enforcement: | <input type="text" value="None"/> | <input type="checkbox"/> |
| URL Content Filter: | <input type="text" value="None"/> | <input type="checkbox"/> |
| Web Content Filter: | <input type="text" value="None"/> | <input type="checkbox"/> |

Advance Setting

Available settings are explained as follows:

| Item | Description |
|----------------------------------------|--------------------------------------------------------------------------------------------------------------------------------------------------------------------------------------------------------------------------------------------------------------------------------------------------------------------------------------------------------------------------------------------------------------------------------------------------------------------------------------------------------------------------------------------------------------------------------------------------------------------------------------|
| Check to enable the Filter Rule | Check this box to enable the filter rule. |
| Comments | Enter filter set comments/description. Maximum length is 14- character long. |
| Index(1-15) | Set PCs on LAN to work at certain time interval only. You may choose up to 4 schedules out of the 15 schedules pre-defined in Applications >> Schedule setup. The default setting of this field is blank and the function will always work. |
| Clear sessions when schedule ON | Check this box to clear the sessions when the above schedule profiles are applied. |
| Direction | Set the direction of packet flow. It is for Data Filter only. For the Call Filter , this setting is not available since Call Filter is only applied to outgoing traffic. <div style="border: 1px solid black; padding: 5px; margin: 5px 0;"> <input type="text" value="LAN/RT/VPN -> WAN"/> <input type="button" value="v"/> LAN/RT/VPN -> WAN WAN -> LAN/RT/VPN LAN/RT/VPN -> LAN/RT/VPN </div> Note: RT means routing domain (for Vigor 2860 only) |
| Source/Destination IP | Click Edit to access into the following dialog to choose the |

source/destination IP or IP ranges.

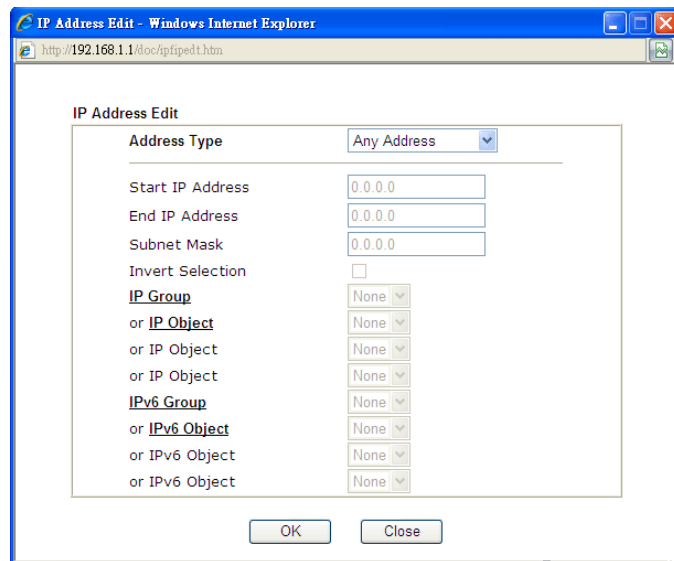

To set the IP address manually, please choose **Any Address/Single Address/Range Address/Subnet Address** as the Address Type and type them in this dialog. In addition, if you want to use the IP range from defined groups or objects, please choose **Group and Objects** as the Address Type.

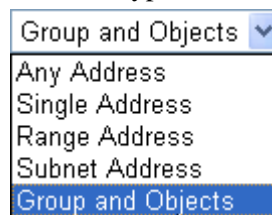

From the **IP Group** drop down list, choose the one that you want to apply. Or use the **IP Object** drop down list to choose the object that you want. Vigor 2760 supports only one subnet on the LAN side.

Service Type

Click **Edit** to access into the following dialog to choose a suitable service type.

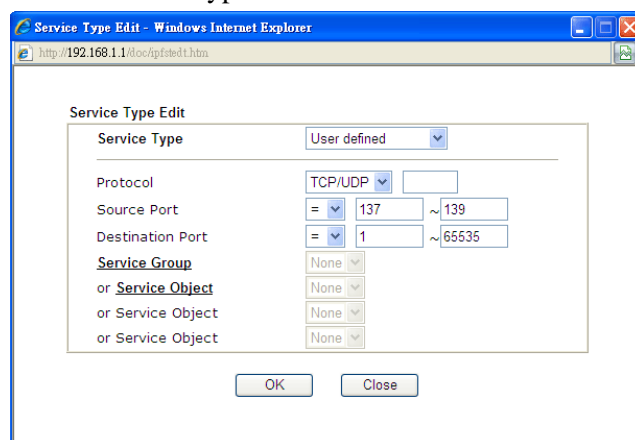

To set the service type manually, please choose **User defined** as the Service Type and type them in this dialog. In addition, if you want to use the service type from defined groups or objects, please choose **Group and Objects** as the

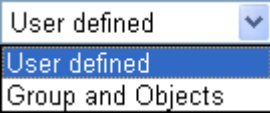
| | |
|-----------------------------------|-----------------------------------------------------------------------------------------------------------------------------------------------------------------------------------------------------------------------------------------------------------------------------------------------------------------------------------------------------------------------------------------------------------------------------------------------------------------------------------------------------------------------------------------------------------------------------------------------------------------------------------------------------------------------------------------------------------------------------------------------------------------------------------------------------------------------------------------------------------------------------------------------------------------------------------------------------------------------|
| | <p>Service Type.</p>  <p>Protocol - Specify the protocol(s) which this filter rule will apply to.</p> <p>Source/Destination Port –</p> <p>(=) – when the first and last value are the same, it indicates one port; when the first and last values are different, it indicates a range for the port and available for this service type.</p> <p>(!=) – when the first and last value are the same, it indicates all the ports except the port defined here; when the first and last values are different, it indicates that all the ports except the range defined here are available for this service type.</p> <p>(>) – the port number greater than this value is available.</p> <p>(<) – the port number less than this value is available for this profile.</p> <p>Service Group/Object - Use the drop down list to choose the one that you want.</p> |
| Fragments | <p>Specify the action for fragmented packets. And it is used for Data Filter only.</p> <p><i>Don't care</i> -No action will be taken towards fragmented packets.</p> <p><i>Unfragmented</i> -Apply the rule to unfragmented packets.</p> <p><i>Fragmented</i> - Apply the rule to fragmented packets.</p> <p><i>Too Short</i> - Apply the rule only to packets that are too short to contain a complete header.</p> |
| Filter | <p>Specifies the action to be taken when packets match the rule.</p> <p>Block Immediately - Packets matching the rule will be dropped immediately.</p> <p>Pass Immediately - Packets matching the rule will be passed immediately.</p> <p>Block If No Further Match - A packet matching the rule, and that does not match further rules, will be dropped.</p> <p>Pass If No Further Match - A packet matching the rule, and that does not match further rules, will be passed through.</p> |
| Branch to other Filter Set | <p>If the packet matches the filter rule, the next filter rule will branch to the specified filter set. Select next filter rule to branch from the drop-down menu. Be aware that the router will apply the specified filter rule for ever and will not return to previous filter rule any more.</p> |
| Sessions Control | <p>The number typed here is the total sessions of the packets that do not match the filter rule configured in this page. The default setting is 60000.</p> |

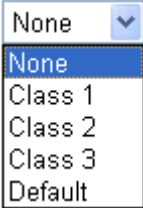
| | |
|---------------------------|----------------------------------------------------------------------------------------------------------------------------------------------------------------------------------------------------------------------------------------------------------------------------------------------------------------------------------------------------------------------------------------------------------------------------------------------------------------------------------------------------------------------------------------------------------------------------------------------------------------------------------------------------------------|
| Quality of Service | <p>Choose one of the QoS rules to be applied as firewall rule. For detailed information of setting QoS, please refer to the related section later.</p>  |
| APP Enforcement | <p>Select an APP Enforcement profile for global IM/P2P application blocking. If there is no profile for you to select, please choose [Create New] from the drop down list in this page to create a new profile. All the hosts in LAN must follow the standard configured in the APP Enforcement profile selected here. For detailed information, refer to the section of APP Enforcement profile setup. For troubleshooting needs, you can specify to record information for IM/P2P by checking the Log box. It will be sent to Syslog server. Please refer to section Syslog/Mail Alert for more detailed information.</p> |
| URL Content Filter | <p>Select one of the URL Content Filter profile settings (created in CSM>> URL Content Filter) for applying with this router. Please set at least one profile for choosing in CSM>> URL Content Filter web page first. Or choose [Create New] from the drop down list in this page to create a new profile. For troubleshooting needs, you can specify to record information for URL Content Filter by checking the Log box. It will be sent to Syslog server. Please refer to section Syslog/Mail Alert for more detailed information.</p> |
| URL Content Filter | <p>Select one of the URL Content Filter profile settings (created in CSM>> URL Content Filter) for applying with this router. Please set at least one profile for choosing in CSM>> URL Content Filter web page first. Or choose [Create New] from the drop down list in this page to create a new profile. For troubleshooting needs, you can specify to record information for URL Content Filter by checking the Log box. It will be sent to Syslog server. Please refer to section Syslog/Mail Alert for more detailed information.</p> |
| Web Content Filter | <p>Select one of the Web Content Filter profile settings (created in CSM>> Web Content Filter) for applying with this router. Please set at least one profile for anti-virus in CSM>> Web Content Filter web page first. Or choose [Create New] from the drop down list in this page to create a new profile. For troubleshooting needs, you can specify to record information for Web Content Filter by checking the Log box. It will be sent to Syslog server. Please refer to section Syslog/Mail Alert for more detailed information.</p> |
| Advance Setting | <p>Click Edit to open the following window. However, it is strongly recommended to use the default settings here.</p> |

Filter Set 1 Rule 1

| | |
|------------------------------------------|-------------------------------------|
| Advance Setting | |
| Codepage | ANSI(1252)-Latin I |
| Window size: | 65535 |
| Session timeout: | 1440 Minute |
| DrayTek Banner: | <input checked="" type="checkbox"/> |
| Strict Security Checking | |
| <input type="checkbox"/> APP Enforcement | |

OK

Close

Codepage - This function is used to compare the characters among different languages. Choose correct codepage can help the system obtaining correct ASCII after decoding data from URL and enhance the correctness of URL Content Filter. The default value for this setting is ANSI 1252 Latin I. If you do not choose any codepage, no decoding job of URL will be processed. Please use the drop-down list to choose a codepage.

If you do not have any idea of choosing suitable codepage, please open Syslog. From Codepage Information of Setup dialog, you will see the recommended codepage listed on the dialog box.

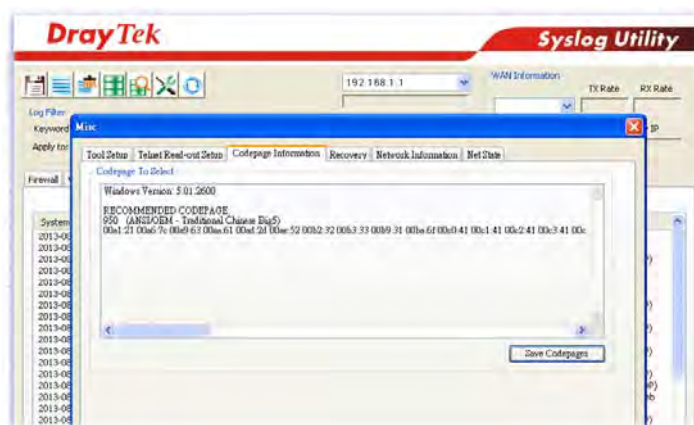

Window size – It determines the size of TCP protocol (0~65535). The more the value is, the better the performance will be. However, if the network is not stable, small value will be proper.

Session timeout–Setting timeout for sessions can make the best utilization of network resources. However, Queue timeout is configured for TCP protocol only; session timeout is configured for the data flow which matched with the firewall rule.

DrayTek Banner – Please uncheck this box and the following screen will not be shown for the unreachable web page. The default setting is Enabled.

The requested Web page has been blocked by Web Content Filter.

Please contact your system administrator for further information.

[Powered by Draytek]

Strict Security Checking - All the packets, while transmitting through Vigor router, will be filtered by firewall settings configured by Vigor router. When the resource is inadequate, the packets will be blocked if Strict Security Checking is enabled. If Strict Security Checking is not enabled, then the packets will pass through the router.

Example

As stated before, all the traffic will be separated and arbitrated using one of two IP filters: call filter or data filter. You may preset 12 call filters and data filters in **Filter Setup** and even link them in a serial manner. Each filter set is composed by 7 filter rules, which can be further defined. After that, in **General Setup** you may specify one set for call filter and one set for data filter to execute first.

The screenshots illustrate the configuration process:

- General Setup:** Shows the 'Start Filter Set' dropdown for both Call Filter and Data Filter, both set to 'Set#1'.
- Filter Setup:** A table listing 12 filter sets. Set 1 is 'Default Call Filter' and Set 2 is 'Default Data Filter'.

| Set | Comments | Set | Comments |
|-----|---------------------|-----|----------|
| 1. | Default Call Filter | 7. | |
| 2. | | 8. | |
| 3. | Default Data Filter | 9. | |
| 4. | | 10. | |
| 5. | | 11. | |
| 6. | | 12. | |
- Filter Set 1:** Shows a list of 7 filter rules. Rule 1 is 'Default Call Filter' and is active.
- Filter Set 1 Rule 1:** Shows the configuration for Rule 1, including 'Block NetBios' and 'Block Immediately' action profile.

3.4.4 DoS Defense

As a sub-functionality of IP Filter/Firewall, there are 15 types of detect/ defense function in the **DoS Defense** setup. The DoS Defense functionality is disabled for default.

Click **Firewall** and click **DoS Defense** to open the setup page.

Firewall >> DoS defense Setup

DoS defense Setup

Enable DoS Defense Select All

| | | | |
|-----------------------------------------------------|-----------|-----------------------------------|---------------|
| <input type="checkbox"/> Enable SYN flood defense | Threshold | <input type="text" value="2000"/> | packets / sec |
| | Timeout | <input type="text" value="10"/> | sec |
| <input type="checkbox"/> Enable UDP flood defense | Threshold | <input type="text" value="2000"/> | packets / sec |
| | Timeout | <input type="text" value="10"/> | sec |
| <input type="checkbox"/> Enable ICMP flood defense | Threshold | <input type="text" value="250"/> | packets / sec |
| | Timeout | <input type="text" value="10"/> | sec |
| <input type="checkbox"/> Enable Port Scan detection | Threshold | <input type="text" value="2000"/> | packets / sec |

Block IP options
 Block Land
 Block Smurf
 Block trace route
 Block SYN fragment
 Block Fraggle Attack

Block TCP flag scan
 Block Tear Drop
 Block Ping of Death
 Block ICMP fragment
 Block Unassigned Numbers

Enable DoS defense function to prevent the attacks from hacker or crackers.

Available settings are explained as follows:

| Item | Description |
|---------------------------------|------------------------------------------------------------------------------------------------------------------------------------------------------------------------------------------------------------------------------------------------------------------------------------------------------------------------------------------------------------------------------------------------------------------------------------------------------------------------------------------------------------------------------------------------------------------------------------------------------------------------------------------------------------------|
| Enable Dos Defense | Check the box to activate the DoS Defense Functionality. |
| Select All | Click this button to select all the items listed below. |
| Enable SYN flood defense | <p>Check the box to activate the SYN flood defense function. Once detecting the Threshold of the TCP SYN packets from the Internet has exceeded the defined value, the Vigor router will start to randomly discard the subsequent TCP SYN packets for a period defined in Timeout. The goal for this is prevent the TCP SYN packets' attempt to exhaust the limited-resource of Vigor router.</p> <p>By default, the threshold and timeout values are set to 2000 packets per second and 10 seconds, respectively. That means, when 2000 packets per second received, they will be regarded as "attack event" and the session will be paused for 10 seconds.</p> |
| Enable UDP flood defense | <p>Check the box to activate the UDP flood defense function. Once detecting the Threshold of the UDP packets from the Internet has exceeded the defined value, the Vigor router will start to randomly discard the subsequent UDP packets for a period defined in Timeout.</p> <p>The default setting for threshold and timeout are 2000</p> |

| | |
|----------------------------------|----------------------------------------------------------------------------------------------------------------------------------------------------------------------------------------------------------------------------------------------------------------------------------------------------------------------------------------------------------------------------------------------------------------------------------------------------------------------------------------------------------------------------------|
| | <p>packets per second and 10 seconds, respectively. That means, when 2000 packets per second received, they will be regarded as “attack event” and the session will be paused for 10 seconds.</p> |
| Enable ICMP flood defense | <p>Check the box to activate the ICMP flood defense function. Similar to the UDP flood defense function, once if the Threshold of ICMP packets from Internet has exceeded the defined value, the router will discard the ICMP echo requests coming from the Internet.</p> <p>The default setting for threshold and timeout are 250 packets per second and 10 seconds, respectively. That means, when 250 packets per second received, they will be regarded as “attack event” and the session will be paused for 10 seconds.</p> |
| Enable PortScan detection | <p>Port Scan attacks the Vigor router by sending lots of packets to many ports in an attempt to find ignorant services would respond. Check the box to activate the Port Scan detection. Whenever detecting this malicious exploration behavior by monitoring the port-scanning Threshold rate, the Vigor router will send out a warning.</p> <p>By default, the Vigor router sets the threshold as 2000 packets per second. That means, when 2000 packets per second received, they will be regarded as “attack event”.</p> |
| Block IP options | <p>Check the box to activate the Block IP options function. The Vigor router will ignore any IP packets with IP option field in the datagram header. The reason for limitation is IP option appears to be a vulnerability of the security for the LAN because it will carry significant information, such as security, TCC (closed user group) parameters, a series of Internet addresses, routing messages...etc. An eavesdropper outside might learn the details of your private networks.</p> |
| Block Land | <p>Check the box to enforce the Vigor router to defense the Land attacks. The Land attack combines the SYN attack technology with IP spoofing. A Land attack occurs when an attacker sends spoofed SYN packets with the identical source and destination addresses, as well as the port number to victims.</p> |
| Block Smurf | <p>Check the box to activate the Block Smurf function. The Vigor router will ignore any broadcasting ICMP echo request.</p> |
| Block trace router | <p>Check the box to enforce the Vigor router not to forward any trace route packets.</p> |
| Block SYN fragment | <p>Check the box to activate the Block SYN fragment function. The Vigor router will drop any packets having SYN flag and more fragment bit set.</p> |
| Block Fraggle Attack | <p>Check the box to activate the Block fraggle Attack function. Any broadcast UDP packets received from the Internet is blocked.</p> <p>Activating the DoS/DDoS defense functionality might</p> |

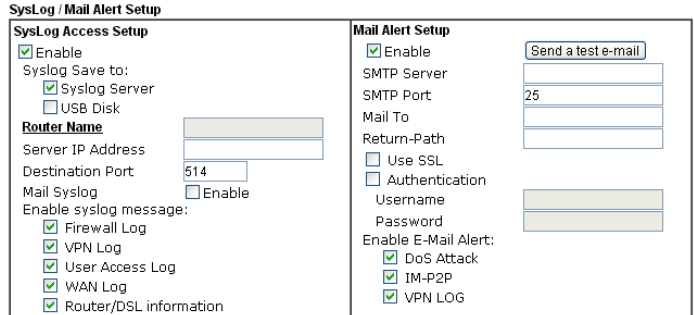
| | |
|---------------------------------|-----------------------------------------------------------------------------------------------------------------------------------------------------------------------------------------------------------------------------------------------------------------------------------------------------------------------------------------------------------------------------------------------------------------------------------------------------------------------------------------------------------------------------------------------------------------------------------------------------------------------------------------------------------------------------------------------------------------------------------------------------------------------------------------------------------------------------------------------|
| | block some legal packets. For example, when you activate the fraggle attack defense, all broadcast UDP packets coming from the Internet are blocked. Therefore, the RIP packets from the Internet might be dropped. |
| Block TCP flag scan | Check the box to activate the Block TCP flag scan function. Any TCP packet with anomaly flag setting is dropped. Those scanning activities include <i>no flag scan</i> , <i>FIN without ACK scan</i> , <i>SYN FINscan</i> , <i>Xmas scan</i> and <i>full Xmas scan</i> . |
| Block Tear Drop | Check the box to activate the Block Tear Drop function. Many machines may crash when receiving ICMP datagrams (packets) that exceed the maximum length. To avoid this type of attack, the Vigor router is designed to be capable of discarding any fragmented ICMP packets with a length greater than 1024 octets. |
| Block Ping of Death | Check the box to activate the Block Ping of Death function. This attack involves the perpetrator sending overlapping packets to the target hosts so that those target hosts will hang once they re-construct the packets. The Vigor routers will block any packets realizing this attacking activity. |
| Block ICMP Fragment | Check the box to activate the Block ICMP fragment function. Any ICMP packets with more fragment bit set are dropped. |
| Block Unassigned Numbers | Check the box to activate the Block Unknown Protocol function. Individual IP packet has a protocol field in the datagram header to indicate the protocol type running over the upper layer. However, the protocol types greater than 100 are reserved and undefined at this time. Therefore, the router should have ability to detect and reject this kind of packets. |
| Warning Messages | <p>We provide Syslog function for user to retrieve message from Vigor router. The user, as a Syslog Server, shall receive the report sending from Vigor router which is a Syslog Client.</p> <p>All the warning messages related to DoS Defense will be sent to user and user can review it through Syslog daemon. Look for the keyword DoS in the message, followed by a name to indicate what kind of attacks is detected.</p> <p>System Maintenance >> SysLog / Mail Alert Setup</p>  <p>Note: 1. Mail Syslog cannot be activated unless USB Disk is ticked for "Syslog Save to". 2. Mail Syslog feature sends a Syslog file when its size reaches 1M Bytes. 3. We only support secured SMTP connection on port 465.</p> |

DrayTek Syslog 4.5.3

DrayTek Syslog Utility

WAN Information: 172.16.3.130 TX Rate RX Rate

LAN Information: TX Packets RX Packets WAN IP Gateway IP

Log Filter
 Keyword: Refresh
 Apply to: All

Firewall VPN User Access Connection WAN PPPoE Others

Show Syslog List Show Defense Alert TOPIID

IP Filter Log CSN Log Defense Log Pause

| System Time | Router Time | Host | Message |
|---------------------|-----------------|--------------|------------------------------------------------------------------------------------------|
| 2013-08-20 11:53:47 | Aug 20 03:53:05 | Vigor-router | [DOS][stack][fraggle_attack][0.0.0.0:68->255.255.255:255:67][UDP][len=20, l1en=576] |
| 2013-08-20 11:53:47 | Aug 20 03:53:05 | Vigor-router | [DOS][stack][fraggle_attack][0.0.0.0:68->255.255.255:255:67][UDP][len=20, l1en=576] |
| 2013-08-20 11:53:46 | Aug 20 03:53:03 | Vigor-router | [DOS][stack][fraggle_attack][192.168.1.10:4744->255.255.255:3997][UDP][len=20, l1en=576] |
| 2013-08-20 11:53:44 | Aug 20 03:53:02 | Vigor-router | [DOS][stack][fraggle_attack][0.0.0.0:68->255.255.255:67][UDP][len=20, l1en=576] |
| 2013-08-20 11:53:44 | Aug 20 03:53:02 | Vigor-router | [DOS][stack][fraggle_attack][0.0.0.0:68->255.255.255:67][UDP][len=20, l1en=576] |

System Time: Time tag from the computer which runs the syslog application Router Time: Time tag from router

3.5 Objects Settings

For IPs in a range and service ports in a limited range usually will be applied in configuring router's settings, therefore we can define them with *objects* and bind them with *groups* for using conveniently. Later, we can select that object/group that can apply it. For example, all the IPs in the same department can be defined with an IP object (a range of IP address).

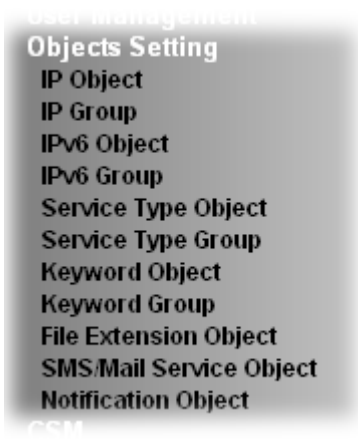

3.5.1 IP Object

You can set up to 192 sets of IP Objects with different conditions.

Objects Setting >> IP Object

IP Object Profiles: | [Set to Factory Default](#) |

| Index | Name | Index | Name |
|---------------------|------|---------------------|------|
| 1. | | 17. | |
| 2. | | 18. | |
| 3. | | 19. | |
| 4. | | 20. | |
| 5. | | 21. | |
| 6. | | 22. | |
| 7. | | 23. | |
| 8. | | 24. | |
| 9. | | 25. | |
| 10. | | 26. | |
| 11. | | 27. | |
| 12. | | 28. | |
| 13. | | 29. | |
| 14. | | 30. | |
| 15. | | 31. | |
| 16. | | 32. | |

<< [1-32](#) | [33-64](#) | [65-96](#) | [97-128](#) | [129-160](#) | [161-192](#) >> [Next](#) >>

Available settings are explained as follows:

| Item | Description |
|-------------------------------|----------------------------------------------------|
| Set to Factory Default | Clear all profiles. |
| Index | Display the profile number that you can configure. |
| Name | Display the name of the object profile. |

To set a new profile, please do the steps listed below:

1. Click the number (e.g., #1) under Index column for configuration in details.
2. The configuration page will be shown as follows:

Objects Setting >> IP Object

Profile Index : 1

| | |
|-------------------|--------------------------|
| Name: | RD Department |
| Interface: | Any |
| Address Type: | Range Address |
| Mac Address: | 00 :00 :00 :00 :00 :00 |
| Start IP Address: | 192.168.1.59 |
| End IP Address: | 192.168.1.65 |
| Subnet Mask: | 0.0.0.0 |
| Invert Selection: | <input type="checkbox"/> |

Available settings are explained as follows:

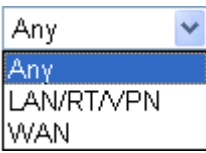
| Item | Description |
|-------------------------|----------------------------------------------------------------------------------------------------------------------------------------------------------------------------------------------------------------------------------------------------------------------------------------------------------------------------------------------------------------------------------------------------------------------------------------------------------------------------------------------------------------------|
| Name | Type a name for this profile. Maximum 15 characters are allowed. |
| Interface | <p>Choose a proper interface.</p>  <p>For example, the Direction setting in Edit Filter Rule will ask you specify IP or IP range for WAN or LAN or any IP address. If you choose LAN as the Interface here, and choose LAN as the direction setting in Edit Filter Rule, then all the IP addresses specified with LAN interface will be opened for you to choose in Edit Filter Rule page.</p> |
| Address Type | Vigor 2760 supports one LAN IP subnet (on IPv4). You can select a single address or the whole local subject. |
| MAC Address | Type the MAC address of the network card which will be controlled. |
| Start IP Address | Type the start IP address for Single Address type. |
| End IP Address | Type the end IP address if the Range Address type is selected. |
| Subnet Mask | Type the subnet mask if the Subnet Address type is selected. |
| Invert Selection | If it is checked, all the IP addresses except the ones listed above will be applied later while it is chosen. |

3. After finishing all the settings here, please click **OK** to save the configuration. Below is an example of IP objects settings.

IP Object Profiles:

| Index | Name | Index |
|--------------|----------------|--------------|
| <u>1.</u> | RD Department | <u>17.</u> |
| <u>2.</u> | Financial Dept | <u>18.</u> |
| <u>3.</u> | HR Department | <u>19.</u> |
| <u>4.</u> | | <u>20.</u> |
| <u>5.</u> | | <u>21.</u> |
| 6. | | 22. |

3.5.2 IP Group

This page allows you to bind several IP objects into one IP group.

Objects Setting >> IP Group

IP Group Table: | [Set to Factory Default](#) |

| Index | Name | Index | Name |
|---------------------|------|---------------------|------|
| 1. | | 17. | |
| 2. | | 18. | |
| 3. | | 19. | |
| 4. | | 20. | |
| 5. | | 21. | |
| 6. | | 22. | |
| 7. | | 23. | |
| 8. | | 24. | |
| 9. | | 25. | |
| 10. | | 26. | |
| 11. | | 27. | |
| 12. | | 28. | |
| 13. | | 29. | |
| 14. | | 30. | |
| 15. | | 31. | |
| 16. | | 32. | |

Available settings are explained as follows:

| Item | Description |
|-------------------------------|----------------------------------------------------|
| Set to Factory Default | Clear all profiles. |
| Index | Display the profile number that you can configure. |
| Name | Display the name of the group profile. |

To set a new profile, please do the steps listed below:

1. Click the number (e.g., #1) under Index column for configuration in details.
2. The configuration page will be shown as follows:

Objects Setting >> IP Group

Profile Index : 1

Name:

Interface:

Available IP Objects

1-RD Department
 2-Financial Dept
 3-HR Department

Selected IP Objects

(Empty)

Available settings are explained as follows:

| Item | Description |
|-----------------------------|---------------------------------------------------------------------------------------------------|
| Name | Type a name for this profile. Maximum 15 characters are allowed. |
| Interface | Choose WAN, LAN or Any to display all the available IP objects with the specified interface. |
| Available IP Objects | All the available IP objects with the specified interface chosen above will be shown in this box. |
| Selected IP Objects | Click >> button to add the selected IP objects in this box. |

3. After finishing all the settings here, please click **OK** to save the configuration.

3.5.3 IPv6 Object

You can set up to 64 sets of IPv6 Objects with different conditions.

Objects Setting >> IPv6 Object

IPv6 Object Profiles: [Set to Factory Default](#)

| Index | Name | Index | Name |
|---------------------|------|---------------------|------|
| 1. | | 17. | |
| 2. | | 18. | |
| 3. | | 19. | |
| 4. | | 20. | |
| 5. | | 21. | |
| 6. | | 22. | |
| 7. | | 23. | |
| 8. | | 24. | |
| 9. | | 25. | |
| 10. | | 26. | |
| 11. | | 27. | |
| 12. | | 28. | |
| 13. | | 29. | |
| 14. | | 30. | |
| 15. | | 31. | |
| 16. | | 32. | |

<< [1-32](#) | [33-64](#) >> [Next](#) >>

Available settings are explained as follows:

| Item | Description |
|-------------------------------|----------------------------------------------------|
| Set to Factory Default | Clear all profiles. |
| Index | Display the profile number that you can configure. |
| Name | Display the name of the object profile. |

To set a new profile, please do the steps listed below:

1. Click the number (e.g., #1) under Index column for configuration in details.
2. The configuration page will be shown as follows:

Objects Setting >> IPv6 Object

Profile Index : 1

| | |
|-------------------|------------------------------------------------|
| Name: | <input type="text"/> |
| Address Type: | <input type="text" value="Subnet Address"/> |
| Mac Address: | <input type="text" value="00:00:00:00:00:00"/> |
| Start IP Address: | <input type="text"/> |
| End IP Address: | <input type="text"/> |
| Prefix Len: | <input type="text"/> |
| Invert Selection: | <input type="checkbox"/> |

Available settings are explained as follows:

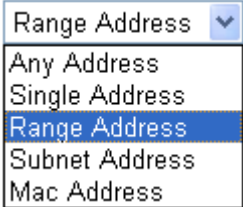
| Item | Description |
|-------------------------|-----------------------------------------------------------------------------------------------------------------------------------------------------------------------------------------------------------------------------------------------------------------------------------------------------------------------------------------------------------------------------------------------------------------------------------------------------------------------------------------------------------------------------------------------------------------|
| Name | Type a name for this profile. Maximum 15 characters are allowed. |
| Address Type | <p>Determine the address type for the IPv6 address.</p> <p>Select Single Address if this object contains one IPv6 address only.</p> <p>Select Range Address if this object contains several IPv6s within a range.</p> <p>Select Subnet Address if this object contains one subnet for IPv6 address.</p> <p>Select Any Address if this object contains any IPv6 address.</p> <p>Select Mac Address if this object contains Mac address.</p>  |
| Mac Address | Type the MAC address of the network card which will be controlled. |
| Start IP Address | Type the start IP address for Single Address type. |
| End IP Address | Type the end IP address if the Range Address type is selected. |
| Prefix Len | Type the number (e.g., 64) for the prefix length of IPv6 address. |
| Invert Selection | If it is checked, all the IPv6 addresses except the ones listed above will be applied later while it is chosen. |

3. After finishing all the settings, please click **OK** to save the configuration.

3.5.4 IPv6 Group

This page allows you to bind several IPv6 objects into one IPv6 group.

Objects Setting >> IPv6 Group

IPv6 Group Table: | [Set to Factory Default](#) |

| Index | Name | Index | Name |
|---------------------|------|---------------------|------|
| 1. | | 17. | |
| 2. | | 18. | |
| 3. | | 19. | |
| 4. | | 20. | |
| 5. | | 21. | |
| 6. | | 22. | |
| 7. | | 23. | |
| 8. | | 24. | |
| 9. | | 25. | |
| 10. | | 26. | |
| 11. | | 27. | |
| 12. | | 28. | |
| 13. | | 29. | |
| 14. | | 30. | |
| 15. | | 31. | |
| 16. | | 32. | |

Available settings are explained as follows:

| Item | Description |
|-------------------------------|----------------------------------------------------|
| Set to Factory Default | Clear all profiles. |
| Index | Display the profile number that you can configure. |
| Name | Display the name of the group profile. |

To set a new profile, please do the steps listed below:

1. Click the number (e.g., #1) under Index column for configuration in details.
2. The configuration page will be shown as follows:

Objects Setting >> IPv6 Group

Profile Index : 1

Name:

Available IPv6 Objects

>>

<<

Selected IPv6 Objects

Available settings are explained as follows:

| Item | Description |
|-------------------------------|-----------------------------------------------------------------------------------------------------|
| Name | Type a name for this profile. Maximum 15 characters are allowed. |
| Available IPv6 Objects | All the available IPv6 objects with the specified interface chosen above will be shown in this box. |
| Selected IPv6 Objects | Click >> button to add the selected IPv6 objects in this box. |

- After finishing all the settings, please click **OK** to save the configuration.

3.5.5 Service Type Object

You can set up to 96 sets of Service Type Objects with different conditions.

Objects Setting >> Service Type Object

Service Type Object Profiles: [Set to Factory Default](#)

| Index | Name | Index | Name |
|---------------------|------|---------------------|------|
| 1. | | 17. | |
| 2. | | 18. | |
| 3. | | 19. | |
| 4. | | 20. | |
| 5. | | 21. | |
| 6. | | 22. | |
| 7. | | 23. | |
| 8. | | 24. | |
| 9. | | 25. | |
| 10. | | 26. | |
| 11. | | 27. | |
| 12. | | 28. | |
| 13. | | 29. | |
| 14. | | 30. | |
| 15. | | 31. | |
| 16. | | 32. | |

<< [1-32](#) | [33-64](#) | [65-96](#) >> [Next](#) >>

Available settings are explained as follows:

| Item | Description |
|-------------------------------|----------------------------------------------------|
| Set to Factory Default | Clear all profiles. |
| Index | Display the profile number that you can configure. |
| Name | Display the name of the object profile. |

To set a new profile, please do the steps listed below:

1. Click the number (e.g., #1) under Index column for configuration in details.
2. The configuration page will be shown as follows:

Objects Setting >> Service Type Object Setup

Profile Index : 1

| | |
|------------------|-----------------------------------------------------------------------|
| Name | <input type="text" value="www"/> |
| Protocol | TCP <input type="text" value="6"/> |
| Source Port | = <input type="text" value="1"/> ~ <input type="text" value="65535"/> |
| Destination Port | = <input type="text" value="1"/> ~ <input type="text" value="65535"/> |

Available settings are explained as follows:

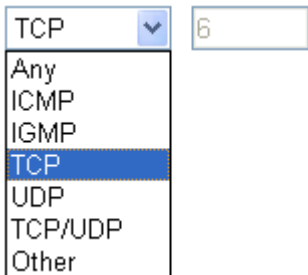
| Item | Description |
|--------------------------------|----------------------------------------------------------------------------------------------------------------------------------------------------------------------------------------------------------------------------------------------------------------------------------------------------------------------------------------------------------------------------------------------------------------------------------------------------------------------------------------------------------------------------------------------------------------------------------------------------------------------------------------------------------------------------------------------------------------------------------------------------------------------------------------------------------------------------|
| Name | Type a name for this profile. Maximum 15 characters are allowed. |
| Protocol | Specify the protocol(s) which this profile will apply to.  |
| Source/Destination Port | <p>Source Port and the Destination Port column are available for TCP/UDP protocol. It can be ignored for other protocols. The filter rule will filter out any port number.</p> <p>(=) – when the first and last value are the same, it indicates one port; when the first and last values are different, it indicates a range for the port and available for this profile.</p> <p>(!=) – when the first and last value are the same, it indicates all the ports except the port defined here; when the first and last values are different, it indicates that all the ports except the range defined here are available for this service type.</p> <p>(>) – the port number greater than this value is available.</p> <p>(<) – the port number less than this value is available for this profile.</p> |

- After finishing all the settings, please click **OK** to save the configuration.

Objects Setting >> Service Type Object

Service Type Object Profiles:

| Index | Name | Index |
|-----------|------|------------|
| <u>1.</u> | www | <u>17.</u> |
| <u>2.</u> | SIP | <u>18.</u> |
| <u>3.</u> | | <u>19.</u> |
| <u>4.</u> | | <u>20.</u> |

3.5.6 Service Type Group

This page allows you to bind several service types into one group.

Objects Setting >> Service Type Group

Service Type Group Table:

[Set to Factory Default](#)

| Group | Name | Group | Name |
|------------|------|------------|------|
| <u>1.</u> | | <u>17.</u> | |
| <u>2.</u> | | <u>18.</u> | |
| <u>3.</u> | | <u>19.</u> | |
| <u>4.</u> | | <u>20.</u> | |
| <u>5.</u> | | <u>21.</u> | |
| <u>6.</u> | | <u>22.</u> | |
| <u>7.</u> | | <u>23.</u> | |
| <u>8.</u> | | <u>24.</u> | |
| <u>9.</u> | | <u>25.</u> | |
| <u>10.</u> | | <u>26.</u> | |
| <u>11.</u> | | <u>27.</u> | |
| <u>12.</u> | | <u>28.</u> | |
| <u>13.</u> | | <u>29.</u> | |
| <u>14.</u> | | <u>30.</u> | |
| <u>15.</u> | | <u>31.</u> | |
| <u>16.</u> | | <u>32.</u> | |

Available settings are explained as follows:

| Item | Description |
|-------------------------------|----------------------------------------------------|
| Set to Factory Default | Clear all profiles. |
| Index | Display the profile number that you can configure. |
| Name | Display the name of the group profile. |

To set a new profile, please do the steps listed below:

1. Click the number (e.g., #1) under Group column for configuration in details.
2. The configuration page will be shown as follows:

Objects Setting >> Service Type Group Setup

Profile Index : 1

Name:

Available Service Type Objects

| |
|-------|
| 1-www |
| 2-SIP |

Selected Service Type Objects

>>

<<

OK Clear Cancel

Available settings are explained as follows:

| Item | Description |
|---------------------------------------|---------------------------------------------------------------------------------------------------------------------------------------|
| Name | Type a name for this profile. Maximum 15 characters are allowed. |
| Available Service Type Objects | All the available service objects that you have added on Objects Setting>>Service Type Object will be shown in this box. |
| Selected Service Type Objects | Click >> button to add the selected IP objects in this box. |

3. After finishing all the settings, please click **OK** to save the configuration.

3.5.7 Keyword Object

You can set 200 keyword object profiles for choosing as black /white list in **CSM >>URL Web Content Filter Profile**.

Objects Setting >> Keyword Object

Keyword Object Profiles: [Set to Factory Default](#)

| Index | Name | Index | Name |
|---------------------|------|---------------------|------|
| 1. | | 17. | |
| 2. | | 18. | |
| 3. | | 19. | |
| 4. | | 20. | |
| 5. | | 21. | |
| 6. | | 22. | |
| 7. | | 23. | |
| 8. | | 24. | |
| 9. | | 25. | |
| 10. | | 26. | |
| 11. | | 27. | |
| 12. | | 28. | |
| 13. | | 29. | |
| 14. | | 30. | |
| 15. | | 31. | |
| 16. | | 32. | |

<< [1-32](#) | [33-64](#) | [65-96](#) | [97-128](#) | [129-160](#) | [161-192](#) | [193-200](#) >> [Next](#) >>

Available settings are explained as follows:

| Item | Description |
|-------------------------------|----------------------------------------------------|
| Set to Factory Default | Clear all profiles. |
| Index | Display the profile number that you can configure. |
| Name | Display the name of the object profile. |

To set a new profile, please do the steps listed below:

1. Click the number (e.g., #1) under Index column for configuration in details.
2. The configuration page will be shown as follows:

Objects Setting >> Keyword Object Setup

Profile Index : 1

| | |
|--------------------------------------------------------------------------------------------------------------|----------------------|
| Name | <input type="text"/> |
| Contents | <input type="text"/> |
| Limit of Contents: Max 3 Words and 63 Characters. Each word should be separated by a single space. | |
| You can replace a character with %HEX. Example: Contents: backdoo%72 virus keep%20out | |
| Result: 1. backdoor 2. virus 3. keep out | |

Available settings are explained as follows:

| Item | Description |
|-----------------|----------------------------------------------------------------------------------------------------------------------------------------------------------------------------------------------------------------------------------------------|
| Name | Type a name for this profile, e.g., game. Maximum 15 characters are allowed. |
| Contents | Type the content for such profile. For example, type <i>gambling</i> as Contents. When you browse the webpage, the page with gambling information will be watched out and be passed/blocked based on the configuration on Firewall settings. |

3. After finishing all the settings, please click **OK** to save the configuration.

3.5.8 Keyword Group

This page allows you to bind several keyword objects into one group. The keyword groups set here will be chosen as black /white list in **CSM >>URL /Web Content Filter Profile**.

Objects Setting >> Keyword Group

Keyword Group Table: | [Set to Factory Default](#) |

| Index | Name | Index | Name |
|------------|------|------------|------|
| <u>1.</u> | | <u>17.</u> | |
| <u>2.</u> | | <u>18.</u> | |
| <u>3.</u> | | <u>19.</u> | |
| <u>4.</u> | | <u>20.</u> | |
| <u>5.</u> | | <u>21.</u> | |
| <u>6.</u> | | <u>22.</u> | |
| <u>7.</u> | | <u>23.</u> | |
| <u>8.</u> | | <u>24.</u> | |
| <u>9.</u> | | <u>25.</u> | |
| <u>10.</u> | | <u>26.</u> | |
| <u>11.</u> | | <u>27.</u> | |
| <u>12.</u> | | <u>28.</u> | |
| <u>13.</u> | | <u>29.</u> | |
| <u>14.</u> | | <u>30.</u> | |
| <u>15.</u> | | <u>31.</u> | |
| <u>16.</u> | | <u>32.</u> | |

Available settings are explained as follows:

| Item | Description |
|-------------------------------|----------------------------------------------------|
| Set to Factory Default | Clear all profiles. |
| Index | Display the profile number that you can configure. |
| Name | Display the name of the group profile. |

To set a new profile, please do the steps listed below:

1. Click the number (e.g., #1) under Index column for configuration in details.
2. The configuration page will be shown as follows:

Objects Setting >> Keyword Group Setup

Profile Index : 1

Name:

Available Keyword Objects

1-Key-1
2-Key-2

Selected Keyword Objects(Max 16 Objects)

(Empty)

Available settings are explained as follows:

| Item | Description |
|----------------------------------|-----------------------------------------------------------------------------------------------------------------------------------------------------------------------------|
| Name | Type a name for this group. Maximum 15 characters are allowed. |
| Available Keyword Objects | You can gather keyword objects from Keyword Object page within one keyword group. All the available Keyword objects that you have created will be shown in this box. |
| Selected Keyword Objects | Click <input type="button" value=">>"/> button to add the selected Keyword objects in this box. |

- After finishing all the settings, please click **OK** to save the configuration.

3.5.9 File Extension Object

This page allows you to set eight profiles which will be applied in **CSM>>URL Content Filter**. All the files with the extension names specified in these profiles will be processed according to the chosen action.

Objects Setting >> File Extension Object

File Extension Object Profiles: | [Set to Factory Default](#) |

| Profile | Name | Profile | Name |
|-----------|------|-----------|------|
| <u>1.</u> | | <u>5.</u> | |
| <u>2.</u> | | <u>6.</u> | |
| <u>3.</u> | | <u>7.</u> | |
| <u>4.</u> | | <u>8.</u> | |

Available settings are explained as follows:

| Item | Description |
|-------------------------------|----------------------------------------------------|
| Set to Factory Default | Clear all profiles. |
| Index | Display the profile number that you can configure. |
| Name | Display the name of the object profile. |

To set a new profile, please do the steps listed below:

1. Click the number (e.g., #1) under Profile column for configuration in details.
2. The configuration page will be shown as follows:

Objects Setting >> File Extension Object Setup

Profile Index: 1 Profile Name:

| Categories | File Extensions |
|--------------------------------------------------------------------------------------------------------------------------------------------------------------------------------------------|--------------------------------------------------------------------------------------------------------------------------------------------------------------------------------------------------------------------------------------------------------------------------------------------------------------------------------------------------------------------------------------------------------------------------------------------|
| Image <input type="button" value="Select All"/> <input type="button" value="Clear All"/> | <input type="checkbox"/> .bmp <input type="checkbox"/> .dib <input type="checkbox"/> .gif <input type="checkbox"/> .jpeg <input type="checkbox"/> .jpg <input type="checkbox"/> .jpg2 <input type="checkbox"/> .jp2 <input type="checkbox"/> .pct <input type="checkbox"/> .pcx <input type="checkbox"/> .pic <input type="checkbox"/> .pict <input type="checkbox"/> .png <input type="checkbox"/> .tif <input type="checkbox"/> .tiff |
| Video <input type="button" value="Select All"/> <input type="button" value="Clear All"/> | <input type="checkbox"/> .asf <input type="checkbox"/> .avi <input type="checkbox"/> .mov <input type="checkbox"/> .mpe <input type="checkbox"/> .mpeg <input type="checkbox"/> .mpg <input type="checkbox"/> .mp4 <input type="checkbox"/> .qt <input type="checkbox"/> .rm <input type="checkbox"/> .wmv <input type="checkbox"/> .3gp <input type="checkbox"/> .3gpp <input type="checkbox"/> .3gpp2 <input type="checkbox"/> .3g2 |
| Audio <input type="button" value="Select All"/> <input type="button" value="Clear All"/> | <input type="checkbox"/> .aac <input type="checkbox"/> .aiff <input type="checkbox"/> .au <input type="checkbox"/> .mp3 <input type="checkbox"/> .m4a <input type="checkbox"/> .m4p <input type="checkbox"/> .ogg <input type="checkbox"/> .ra <input type="checkbox"/> .ram <input type="checkbox"/> .vox <input type="checkbox"/> .wav <input type="checkbox"/> .wma |
| Java <input type="button" value="Select All"/> <input type="button" value="Clear All"/> | <input type="checkbox"/> .class <input type="checkbox"/> .jad <input type="checkbox"/> .jar <input type="checkbox"/> .jav <input type="checkbox"/> .java <input type="checkbox"/> .jcm <input type="checkbox"/> .js <input type="checkbox"/> .jse <input type="checkbox"/> .jsp <input type="checkbox"/> .jtk |
| ActiveX <input type="button" value="Select All"/> <input type="button" value="Clear All"/> | <input type="checkbox"/> .alx <input type="checkbox"/> .apb <input type="checkbox"/> .axs <input type="checkbox"/> .ocx <input type="checkbox"/> .olb <input type="checkbox"/> .ole <input type="checkbox"/> .tlb <input type="checkbox"/> .viv <input type="checkbox"/> .vrm |
| Compression <input type="checkbox"/> <input type="checkbox"/> <input type="checkbox"/> <input type="checkbox"/> <input type="checkbox"/> <input type="checkbox"/> <input type="checkbox"/> | |

Available settings are explained as follows:

| Item | Description |
|---------------------|-------------------------------------------------------------------------------------------|
| Profile Name | Type a name for this profile. The maximum length of the name you can set is 7 characters. |

3. Type a name for such profile and check all the items of file extension that will be processed in the router. Finally, click **OK** to save this profile.

3.5.10 SMS/Mail Service Object

SMS Service Object

This page allows you to set ten profiles which will be applied in **Application>>SMS/Mail Alert Service**.

Object Settings >> SMS / Mail Service Object

| SMS Provider | | Mail Server | Set to Factory Default |
|--------------|--------------|--------------------|----------------------------------------|
| Index | Profile Name | SMS Provider | |
| <u>1.</u> | | kotsms.com.tw (TW) | |
| <u>2.</u> | | kotsms.com.tw (TW) | |
| <u>3.</u> | | kotsms.com.tw (TW) | |
| <u>4.</u> | | kotsms.com.tw (TW) | |
| <u>5.</u> | | kotsms.com.tw (TW) | |
| <u>6.</u> | | kotsms.com.tw (TW) | |
| <u>7.</u> | | kotsms.com.tw (TW) | |
| <u>8.</u> | | kotsms.com.tw (TW) | |
| <u>9.</u> | Custom 1 | | |
| <u>10.</u> | Custom 2 | | |

Each item is explained as follows:

| Item | Description |
|-------------------------------|-------------------------------------------------------------------|
| Set to Factory Default | Clear all of the settings and return to factory default settings. |
| Index | Display the profile number that you can configure. |
| Profile | Display the name for such SMS profile. |
| SMS Provider | Display the service provider which offers SMS service. |

To set a new profile, please do the steps listed below:

1. Click the **SMS Provider** tab, and click the number (e.g., #1) under Index column for configuration in details.

Object Settings >> SMS / Mail Service Object

| SMS Provider | | Mail Server |
|--------------|--------------|-------------|
| Index | Profile Name | |
| <u>1.</u> | | |
| <u>2.</u> | | |
| <u>3.</u> | | |
| <u>4.</u> | | |

- The configuration page will be shown as follows:

Object Settings >> SMS / Mail Service Object

Profile Index: 1

| | |
|------------------|-------------------------------------------------|
| Profile Name | <input type="text" value="Line_down"/> |
| Service Provider | <input type="text" value="kotsms.com.tw (TW)"/> |
| Username | <input type="text" value="line1"/> |
| Password | <input type="password" value="••••"/> |
| Quota | <input type="text" value="10"/> |
| Sending Interval | <input type="text" value="3"/> (seconds) |

Available settings are explained as follows:

| Item | Description |
|-------------------------|-----------------------------------------------------------------------------------------------------------------------------------------------------------------------|
| Profile Name | Type a name for such SMS profile. The maximum length of the name you can set is 31 characters. |
| Service Provider | Use the drop down list to specify the service provider which offers SMS service. |
| Username | Type a user name that the sender can use to register to selected SMS provider. The maximum length of the name you can set is 31 characters. |
| Password | Type a password that the sender can use to register to selected SMS provider. The maximum length of the password you can set is 31 characters. |
| Quota | Type the number of the credit that you purchase from the service provider chosen above. Note that one credit equals to one SMS text message on the standard route. |
| Sending Interval | To avoid quota being exhausted soon, type time interval for sending the SMS. |

- After finishing all the settings here, please click **OK** to save the configuration.

Object Settings >> SMS / Mail Service Object

| SMS Provider | Mail Server | Set to Factory Default |
|--------------|---------------------|----------------------------------------|
| Index | Profile Name | SMS Provider |
| 1. | Line_down | kotsms.com.tw (TW) |
| 2. | | kotsms.com.tw (TW) |
| 3. | | kotsms.com.tw (TW) |
| 4. | | kotsms.com.tw (TW) |

Customized SMS Service

Vigor router offers several SMS service provider to offer the SMS service. However, if your service provider cannot be found from the service provider list, simply use Index 9 and Index 10 to make customized SMS service. The profile name for Index 9 and Index 10 are fixed.

Object Settings >> SMS / Mail Service Object

| SMS Provider | Mail Server | Set to Factory Default |
|---------------------|--------------|----------------------------------------|
| Index | Profile Name | SMS Provider |
| 1. | | kotsms.com.tw (TW) |
| 2. | | kotsms.com.tw (TW) |
| 3. | | kotsms.com.tw (TW) |
| 4. | | kotsms.com.tw (TW) |
| 5. | | kotsms.com.tw (TW) |
| 6. | | kotsms.com.tw (TW) |
| 7. | | kotsms.com.tw (TW) |
| 8. | | kotsms.com.tw (TW) |
| 9. | Custom 1 | |
| 10. | Custom 2 | |

You can click the number (e.g., #9) under Index column for configuration in details.

Object Settings >> SMS / Mail Service Object

Profile Index: 9

| | |
|-------------------------------------------------------------------------------------------------------------------------------------------------------------------------------------------------------------------------------------------------------------------|------------------------------------------|
| Profile Name | <input type="text" value="Custom 1"/> |
| Service Provider | <input type="text"/> |
| <div style="border: 1px solid gray; height: 40px; width: 100%;"></div> | |
| <p>Please contact with your SMS provide to get the exact URL String eg:bulksms.vsms.net:5567/eapi/submission/send_sms/2/2.0?username=###txtUser### &password=###txtPwd###&msisdn=###txtDest###&message=###txtMsg###</p> | |
| Username | <input type="text"/> |
| Password | <input type="text"/> |
| Quota | <input type="text" value="10"/> |
| Sending Interval | <input type="text" value="3"/> (seconds) |

Available settings are explained as follows:

| Item | Description |
|-------------------------|----------------------------------------------------------------------------------------------------------------------------------------------------------------------------------------|
| Profile Name | Display the name of this profile. It cannot be modified. |
| Service Provider | Type the website of the service provider. Type the URL string in the box under the filed of Service Provider. You have to contact your SMS provider to obtain the exact URL string. |

| | |
|-------------------------|---------------------------------------------------------------------------------------------------------------------------------------------------|
| Username | Type a user name that the sender can use to register to selected SMS provider. The maximum length of the name you can set is 31 characters. |
| Password | Type a password that the sender can use to register to selected SMS provider. The maximum length of the password you can set is 31 characters. |
| Quota | Type the total number of the messages that the router will send out. |
| Sending Interval | Type the shortest time interval for the system to send SMS. |

After finishing all the settings here, please click **OK** to save the configuration.

Mail Service Object

This page allows you to set ten profiles which will be applied in **Application>>SMS/Mail Alert Service**.

Object Settings >> SMS / Mail Service Object

| SMS Provider | Mail Server | Set to Factory Default |
|--------------|---------------------|----------------------------------------|
| Index | Profile Name | |
| <u>1.</u> | | |
| <u>2.</u> | | |
| <u>3.</u> | | |
| <u>4.</u> | | |
| <u>5.</u> | | |
| <u>6.</u> | | |
| <u>7.</u> | | |
| <u>8.</u> | | |
| <u>9.</u> | | |
| <u>10.</u> | | |

Each item is explained as follows:

| Item | Description |
|-------------------------------|-------------------------------------------------------------------|
| Set to Factory Default | Clear all of the settings and return to factory default settings. |
| Index | Display the profile number that you can configure. |
| Profile | Display the name for such mail server profile. |

To set a new profile, please do the steps listed below:

1. Click the **Mail Server** tab, and click the number (e.g., #1) under Index column for configuration in details.

Object Settings >> SMS / Mail Service Object

| SMS Provider | Mail Server |
|--------------|-------------|
| Index | |
| <u>1.</u> | |
| <u>2.</u> | |
| <u>3.</u> | |
| <u>4.</u> | |

2. The configuration page will be shown as follows:

Object Settings >> SMS / Mail Service Object

Profile Index: 1

| | |
|----------------------------------------------------|----------------------------------------------------|
| Profile Name | <input type="text" value="Mail_Notify"/> |
| SMTP Server | <input type="text" value="192.168.1.98"/> |
| SMTP Port | <input type="text" value="25"/> |
| Sender Address | <input type="text" value="carrie_ni@draytek.com"/> |
| <input type="checkbox"/> Use SSL | |
| <input checked="" type="checkbox"/> Authentication | |
| Username | <input type="text" value="John"/> |
| Password | <input type="password" value="••••"/> |
| Sending Interval | <input type="text" value="0"/> (seconds) |

Available settings are explained as follows:

| Item | Description |
|-----------------------|-------------------------------------------------------------------------------------------------------------------------------------------------------------------------------------------------------------------------------------------------------------------------------------------------------------------------------------------------------------------------------------------------------------|
| Profile Name | Type a name for such mail service profile. The maximum length of the name you can set is 31 characters. |
| SMTP Server | Type the IP address of the mail server. The maximum length of the name you can set is 63 characters. |
| SMTP Port | Type the port number for SMTP server. |
| Sender Address | Type the e-mail address of the sender. |
| Use SSL | Check this box to use port 465 for SMTP server for some e-mail server uses https as the transmission method. |
| Authentication | <p>The mail server must be authenticated with the correct username and password to have the right of sending message out. Check the box to enable the function.</p> <p>Username – Type a name for authentication. The maximum length of the name you can set is 31 characters.</p> <p>Password – Type a password for authentication. The maximum length of the password you can set is 31</p> |

| | |
|-------------------------|---------------------------------------------------------|
| | characters. |
| Sending Interval | Define the interval for the system to send the SMS out. |

- After finishing all the settings here, please click **OK** to save the configuration.

Object Settings >> SMS / Mail Service Object

| SMS Provider | Mail Server | Set to Factory Default |
|--------------|---------------------|----------------------------------------|
| Index | Profile Name | |
| <u>1.</u> | Mail_Notify | |
| <u>2.</u> | | |
| <u>3.</u> | | |

3.5.11 Notification Object

This page allows you to set ten profiles which will be applied in **Application>>SMS/Mail Alert Service**.

You can set an object with different monitoring situation.

Object Settings >> Notification Object

| Index | Profile Name | Settings | Set to Factory Default |
|-----------|--------------|----------|----------------------------------------|
| <u>1.</u> | | | |
| <u>2.</u> | | | |
| <u>3.</u> | | | |
| <u>4.</u> | | | |
| <u>5.</u> | | | |
| <u>6.</u> | | | |
| <u>7.</u> | | | |
| <u>8.</u> | | | |

To set a new profile, please do the steps listed below:

- Open **Object Setting>>Notification Object**, and click the number (e.g., #1) under Index column for configuration in details.

Object Settings >> Notification Object

| Index | Profile Name |
|-----------|--------------|
| <u>1.</u> | |
| <u>2.</u> | |
| <u>3.</u> | |
| <u>4.</u> | |
| <u>5.</u> | |

- The configuration page will be shown as follows:

Object Settings >> Notification Object

Profile Index: 1

| | | |
|-----------------|---------------------------------------|--------------------------------------|
| Profile Name | Notify_attack | |
| Category | Status | |
| WAN | <input type="checkbox"/> Disconnected | <input type="checkbox"/> Reconnected |
| VPN Tunnel | <input type="checkbox"/> Disconnected | <input type="checkbox"/> Reconnected |

Available settings are explained as follows:

| Item | Description |
|---------------------|---------------------------------------------------------------------------------------------------------|
| Profile Name | Type a name for such notification profile. The maximum length of the name you can set is 15 characters. |
| Category | Display the types that will be monitored. |
| Status | Display the status for the category. You can check the box you want to be monitored. |

- After finishing all the settings here, please click **OK** to save the configuration.

Object Settings >> Notification Object

| Index | Profile Name | Settings |
|-------|---------------|----------|
| 1. | Notify_attack | WAN VPN |
| 2. | | |
| 3. | | |

[Set to Factory Default](#)

3.6 CSM Profile

Content Security Management (CSM)

CSM is an abbreviation of **Content Security Management** which is used to control IM/P2P usage, filter the web content and URL content to reach a goal of security management.

APP Enforcement Filter

As the popularity of all kinds of instant messenger application arises, communication cannot become much easier. Nevertheless, while some industry may leverage this as a great tool to connect with their customers, some industry may take reserve attitude in order to reduce employee misuse during office hour or prevent unknown security leak. It is similar situation for corporation towards peer-to-peer applications since file-sharing can be convenient but insecure at the same time. To address these needs, we provide CSM functionality.

URL Content Filter

To provide an appropriate cyberspace to users, Vigor router equips with **URL Content Filter** not only to limit illegal traffic from/to the inappropriate web sites but also prohibit other web feature where malicious code may conceal.

Once a user type in or click on an URL with objectionable keywords, URL keyword blocking facility will decline the HTTP request to that web page thus can limit user's access to the website. You may imagine **URL Content Filter** as a well-trained convenience-store clerk who won't sell adult magazines to teenagers. At office, **URL Content Filter** can also provide a job-related only environment hence to increase the employee work efficiency. How can URL Content Filter work better than traditional firewall in the field of filtering? Because it checks the URL strings or some of HTTP data hiding in the payload of TCP packets while legacy firewall inspects packets based on the fields of TCP/IP headers only.

On the other hand, Vigor router can prevent user from accidentally downloading malicious codes from web pages. It's very common that malicious codes conceal in the executable objects, such as ActiveX, Java Applet, compressed files, and other executable files. Once downloading these types of files from websites, you may risk bringing threat to your system. For example, an ActiveX control object is usually used for providing interactive web feature. If malicious code hides inside, it may occupy user's system.

Web Content Filter

We all know that the content on the Internet just like other types of media may be inappropriate sometimes. As a responsible parent or employer, you should protect those in your trust against the hazards. With Web filtering service of the Vigor router, you can protect your business from common primary threats, such as productivity, legal liability, network and security threats. For parents, you can protect your children from viewing adult websites or chat rooms.

Once you have activated your Web Filtering service in Vigor router and chosen the categories of website you wish to restrict, each URL address requested (e.g. www.bbc.co.uk) will be checked against our server database. This database is updated as frequent as daily by a global team of Internet researchers. The server will look up the URL and return a category to your router. Your Vigor router will then decide whether to allow access to this site according to the categories you have selected. Please note that this action will not introduce any delay in your Web surfing because each of multiple load balanced database servers can handle millions of requests for categorization.

Note: The priority of URL Content Filter is higher than Web Content Filter.

3.6.1 APP Enforcement Profile

You can define policy profiles for IM (Instant Messenger)/P2P (Peer to Peer)/Protocol/Misc application. This page allows you to set 32 profiles for different requirements. The APP Enforcement Profile will be applied in **Default Rule of Firewall>>General Setup** for filtering.

CSM >> APP Enforcement Profile

APP Enforcement Profile Table: [Set to Factory Default](#)

| Profile | Name | Profile | Name |
|---------------------|------|---------------------|------|
| 1. | | 17. | |
| 2. | | 18. | |
| 3. | | 19. | |
| 4. | | 20. | |
| 5. | | 21. | |
| 6. | | 22. | |
| 7. | | 23. | |
| 8. | | 24. | |
| 9. | | 25. | |
| 10. | | 26. | |
| 11. | | 27. | |
| 12. | | 28. | |
| 13. | | 29. | |
| 14. | | 30. | |
| 15. | | 31. | |
| 16. | | 32. | |

Available settings are explained as follows:

| Item | Description |
|-------------------------------|--------------------------------------------------------------------------------------|
| Set to Factory Default | Clear all profiles. |
| Profile | Display the number of the profile which allows you to click to set different policy. |
| Name | Display the name of the APP Enforcement Profile. |

Click the number under Index column for settings in detail.

There are four tabs IM, P2P, Protocol and Misc displayed on this page. Each tab will bring out different items that you can choose to disallow people using.

Below shows the items which are categorized under **Protocol**.

CSM >> APP Enforcement Profile

Profile Index : 1 Profile Name:

| IM | P2P | Protocol | OTHERS |
|-------------------------------------------|------------------------------------------|-----------------------------------------------|-----------------------------------|
| <input type="button" value="Select All"/> | <input type="button" value="Clear All"/> | Action : <input type="button" value="Block"/> | |
| Protocol | | | |
| <input type="checkbox"/> DNS | <input type="checkbox"/> FTP | <input type="checkbox"/> HTTP | <input type="checkbox"/> IMAP |
| <input type="checkbox"/> NNTP | <input type="checkbox"/> POP3 | <input type="checkbox"/> SMB | <input type="checkbox"/> SMTP |
| <input type="checkbox"/> SSH | <input type="checkbox"/> SSL/TLS | <input type="checkbox"/> TELNET | <input type="checkbox"/> MSSQL |
| <input type="checkbox"/> Oracle | <input type="checkbox"/> PostgreSQL | <input type="checkbox"/> Sybase | <input type="checkbox"/> DB2 |
| | | | <input type="checkbox"/> IRC |
| | | | <input type="checkbox"/> SNMP |
| | | | <input type="checkbox"/> MySQL |
| | | | <input type="checkbox"/> Informix |

Available settings are explained as follows:

| Item | Description |
|---------------------|-----------------------------------------------------------------------------------------------|
| Profile Name | Type a name for the CSM profile. The maximum length of the name you can set is 15 characters. |
| Select All | Click it to choose all of the items in this page. |
| Clear All | Uncheck all the selected boxes. |

The profiles configured here can be applied in the **Firewall>>General Setup** and **Firewall>>Filter Setup** pages as the standard for the host(s) to follow.

Below shows the items which are categorized under **IM**.

CSM >> APP Enforcement Profile

Profile Index : 1 Profile Name:

| IM | P2P | Protocol | OTHERS |
|-------------------------------------------|--------------------------------------------------------|-----------------------------------------------------------|------------------------------------------------------------|
| <input type="button" value="Select All"/> | <input type="button" value="Clear All"/> | Action : <input type="button" value="Block"/> | |
| Advanced Management | | | |
| Activity / Application | MSN | YahooIM | AIM(<= v5.9) |
| Login | <input type="checkbox"/> | <input type="checkbox"/> | <input type="checkbox"/> |
| Message | <input type="checkbox"/> | <input type="checkbox"/> | <input type="checkbox"/> |
| File Transfer | <input type="checkbox"/> | <input type="checkbox"/> | <input type="checkbox"/> |
| Game | <input type="checkbox"/> | <input type="checkbox"/> | <input type="checkbox"/> |
| Conference(Video/Voice) | <input type="checkbox"/> | <input type="checkbox"/> | <input type="checkbox"/> |
| Other Activities | <input type="checkbox"/> | <input type="checkbox"/> | <input type="checkbox"/> |
| IM Application | | | VoIP |
| <input type="checkbox"/> AIM6/7 | <input type="checkbox"/> QQ/TM | <input type="checkbox"/> iMessge | <input type="checkbox"/> Jabber/GoogleTalk |
| <input type="checkbox"/> GoogleChat | <input type="checkbox"/> XFire | <input type="checkbox"/> GaduGadu | <input type="checkbox"/> Paltalk |
| <input type="checkbox"/> Qnext | <input type="checkbox"/> POCO/PP365 | <input type="checkbox"/> AresChat | <input type="checkbox"/> AliWWW |
| <input type="checkbox"/> Lava-Lava | <input type="checkbox"/> ICU2 | <input type="checkbox"/> iSpQ | <input type="checkbox"/> UC |
| <input type="checkbox"/> MobileMSN | <input type="checkbox"/> BaiduHi | <input type="checkbox"/> Fetion | <input type="checkbox"/> LINE |
| | | | <input type="checkbox"/> Skype |
| | | | <input type="checkbox"/> Kubao |
| | | | <input type="checkbox"/> Gizmo |
| | | | <input type="checkbox"/> SIP/RTP |
| | | | <input type="checkbox"/> TelTel |
| | | | <input type="checkbox"/> TeamSpeak |
| | | | <input type="checkbox"/> RaidCall |
| Web IM (* = more than one address) | | | |
| <input type="checkbox"/> WebIM URLs | eMessenger ICQ Java' KoolIM | WebMSN ICQ Flash' MessengerFX' | meebo' goovv' Messenger Adictos |
| | | | eBuddy mabber' WebYahooIM |
| | | | ILoveIM' MSN2GO' |

The items categorized under P2P -----

CSM >> APP Enforcement Profile

Profile Index : 1 Profile Name:

| IM | P2P | Protocol | OTHERS |
|-------------------------------------------------------------------------|------------|---------------------------------------------|----------|
| <input type="button" value="Select All"/> | | <input type="button" value="Clear All"/> | |
| Protocol | | Applications | |
| <input type="checkbox"/> | SoulSeek | SoulSeek | |
| <input type="checkbox"/> | eDonkey | eDonkey, eMule, Shareaza | |
| <input type="checkbox"/> | FastTrack | KazaA, BearShare, iMesh | |
| <input type="checkbox"/> | OpenFT | KCeasy, FilePipe | |
| <input type="checkbox"/> | Gnutella | BearShare, Limewire, Shareaza, Foxy, KCeasy | |
| <input type="checkbox"/> | OpenNap | Lopster, XNap, WinLop | |
| <input type="checkbox"/> | BitTorrent | BitTorrent, BitSpirit, BitComet | |
| Other P2P Applications | | | |
| <input type="checkbox"/> | Xunlei | <input type="checkbox"/> | Vagaa |
| <input type="checkbox"/> | Ares | <input type="checkbox"/> | ezPeer |
| <input type="checkbox"/> | PP365 | <input type="checkbox"/> | POCO |
| <input type="checkbox"/> | Pando | <input type="checkbox"/> | Huntmine |
| <input type="checkbox"/> | Clubbox | <input type="checkbox"/> | Kuwo |
| <input type="button" value="OK"/> <input type="button" value="Cancel"/> | | | |

The items categorized under OTHERS-----

CSM >> APP Enforcement Profile

Profile Index : 1 Profile Name:

| IM | P2P | Protocol | OTHERS |
|-------------------------------------------------------------------------|------------------|------------------------------------------|-----------------|
| <input type="button" value="Select All"/> | | <input type="button" value="Clear All"/> | |
| Tunneling | | | |
| <input type="checkbox"/> | Socks4/5 | <input type="checkbox"/> | PGPNet |
| <input type="checkbox"/> | SoftEther | <input type="checkbox"/> | MS TEREDO |
| <input type="checkbox"/> | Ping Tunnel | <input type="checkbox"/> | TinyVPN |
| <input type="checkbox"/> | FreeU | <input type="checkbox"/> | Skyfire |
| <input type="checkbox"/> | HTTP Proxy | <input type="checkbox"/> | Wujie/UltraSurf |
| <input type="checkbox"/> | Tor | <input type="checkbox"/> | RealTunnel |
| <input type="checkbox"/> | VNN | <input type="checkbox"/> | Hotspot Shield |
| <input type="checkbox"/> | Hamachi | <input type="checkbox"/> | DynaPass |
| <input type="checkbox"/> | HTTP Tunnel | <input type="checkbox"/> | UltraVPN |
| Streaming | | | |
| <input type="checkbox"/> | MMS | <input type="checkbox"/> | RTSP |
| <input type="checkbox"/> | FeiDian | <input type="checkbox"/> | UUSee |
| <input type="checkbox"/> | SopCast | <input type="checkbox"/> | UDLiveX |
| <input type="checkbox"/> | FlashVideo | <input type="checkbox"/> | SilverLight |
| <input type="checkbox"/> | TVAnts | <input type="checkbox"/> | PPStream |
| <input type="checkbox"/> | NSPlayer | <input type="checkbox"/> | PCAST |
| <input type="checkbox"/> | TVUPlayer | <input type="checkbox"/> | MySee |
| <input type="checkbox"/> | Slingbox | <input type="checkbox"/> | QVOD |
| <input type="checkbox"/> | PPTV | <input type="checkbox"/> | TVKoo |
| <input type="checkbox"/> | Joost | | |
| Remote Control | | | |
| <input type="checkbox"/> | VNC | <input type="checkbox"/> | Radmin |
| <input type="checkbox"/> | TeamViewer | <input type="checkbox"/> | Gogrok |
| <input type="checkbox"/> | pcAnywhere | <input type="checkbox"/> | Timbuktu |
| <input type="checkbox"/> | SpyAnywhere | <input type="checkbox"/> | ShowMyPC |
| <input type="checkbox"/> | RemoteControlPro | <input type="checkbox"/> | CrossLoop |
| <input type="checkbox"/> | WindowsLiveSync | <input type="checkbox"/> | SharedView |
| <input type="checkbox"/> | LogMeIn | <input type="checkbox"/> | WindowsRDP |
| Web HD | | | |
| <input type="checkbox"/> | HTTP Upload | <input type="checkbox"/> | HiNet SafeBox |
| <input type="checkbox"/> | MyOtherDrive | <input type="checkbox"/> | Mozy |
| <input type="checkbox"/> | Google Service | <input type="checkbox"/> | iCloud |
| <input type="checkbox"/> | MS SkyDrive | <input type="checkbox"/> | GDoc Uploader |
| <input type="checkbox"/> | BoxNet | <input type="checkbox"/> | OfficeLive |
| <input type="checkbox"/> | ADrive | <input type="checkbox"/> | DropBox |
| <input type="button" value="OK"/> <input type="button" value="Cancel"/> | | | |

3.6.2 URL Content Filter Profile

To provide an appropriate cyberspace to users, Vigor router equips with **URL Content Filter** not only to limit illegal traffic from/to the inappropriate web sites but also prohibit other web feature where malicious code may conceal.

Once a user type in or click on an URL with objectionable keywords, URL keyword blocking facility will decline the HTTP request to that web page thus can limit user’s access to the website. You may imagine **URL Content Filter** as a well-trained convenience-store clerk who won’t sell adult magazines to teenagers. At office, **URL Content Filter** can also provide a job-related only environment hence to increase the employee work efficiency. How can URL Content Filter work better than traditional firewall in the field of filtering? Because it checks the URL strings or some of HTTP data hiding in the payload of TCP packets while legacy firewall inspects packets based on the fields of TCP/IP headers only.

On the other hand, Vigor router can prevent user from accidentally downloading malicious codes from web pages. It’s very common that malicious codes conceal in the executable objects, such as ActiveX, Java Applet, compressed files, and other executable files. Once downloading these types of files from websites, you may risk bringing threat to your system. For example, an ActiveX control object is usually used for providing interactive web feature. If malicious code hides inside, it may occupy user’s system.

For example, if you add key words such as “sex”, Vigor router will limit web access to web sites or web pages such as “www.sex.com”, ”www.backdoor.net/images/sex/p_386.html”. Or you may simply specify the full or partial URL such as “www.sex.com” or “sex.com”.

Also the Vigor router will discard any request that tries to retrieve the malicious code.

Click **CSM** and click **URL Content Filter Profile** to open the profile setting page.

CSM >> URL Content Filter Profile 

URL Content Filter Profile Table: [Set to Factory Default](#)

| Profile | Name | Profile | Name |
|-----------|------|-----------|------|
| <u>1.</u> | | <u>5.</u> | |
| <u>2.</u> | | <u>6.</u> | |
| <u>3.</u> | | <u>7.</u> | |
| <u>4.</u> | | <u>8.</u> | |

Administration Message (Max 255 characters) Default Message

```
<body><center><br><p>The requested Web page has been blocked by URL Content Filter.<p>Please contact your system administrator for further information.</center></body>
```

Each item is explained as follows:

| Item | Description |
|-------------------------------|--------------------------------------------------------------------------------------|
| Set to Factory Default | Clear all profiles. |
| Profile | Display the number of the profile which allows you to click to set different policy. |
| Name | Display the name of the URL Content Filter Profile. |

Administration Message

You can type the message manually for your necessity.

Default Message - You can type the message manually for your necessity or click this button to get the default message which will be displayed on the field of **Administration Message**.

You can set eight profiles as URL content filter. Simply click the index number under Profile to open the following web page.

CSM >> URL Content Filter Profile

Profile Index: 1

Profile Name:

Priority: Log:

1.URL Access Control

Enable URL Access Control Prevent web access from IP address

Action: Group/Object Selections:



2.Web Feature

Enable Restrict Web Feature

Action: Cookie Proxy Upload File Extension Profile:

Available settings are explained as follows:

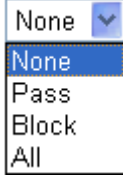
| Item | Description |
|---------------------|--------------------------------------------------------------------------------------------------------------------------------------------------------------------------------------------------------------------------------------------------------------------------------------------------------------------------------------------------------------------------------------------------------------------------------------------------------------------------------------------------------------------------------------------------------------------------------------------------------------------------------------------------------------------------------------------------------------------------------------------------------------------------------------------------------------------------------------------------------------------------------------------------------------------------------------------------------------------------------------------------------|
| Profile Name | Type a name for the CSM profile. The maximum length of the name you can set is 15 characters. |
| Priority | <p>It determines the action that this router will apply.</p> <p>Both: Pass – The router will let all the packages that match with the conditions specified in URL Access Control and Web Feature below passing through. When you choose this setting, both configuration set in this page for URL Access Control and Web Feature will be inactive.</p> <p>Both:Block –The router will block all the packages that match with the conditions specified in URL Access Control and Web Feature below. When you choose this setting, both configuration set in this page for URL Access Control and Web Feature will be inactive.</p> <p>Either: URL Access Control First – When all the packages matching with the conditions specified in URL Access Control and Web Feature below, such function can determine the priority for the actions executed. For this one, the router will process the packages with the conditions set below for URL first, then Web feature second.</p> |

| | |
|----------------------------------|---------------------------------------------------------------------------------------------------------------------------------------------------------------------------------------------------------------------------------------------------------------------------------------------------------------------------------------------------------------------------------------------------------------------------------------------------------------------------------------------------------------------------------------------------------------------------------------------------------------------------------------------------------------------------------------------------------------------------------------------------------------------------------------------------------------------------------------------------------------------------------------------------------------------------------------------------------------------------------------------------------------------------------------------------------------------------------------------------------------------------------------------------------------------------------------------------------------------------------------------------------------------------------------------------------------------------------------------------------------------------------------------------------------------------------------------------------------------------|
| | <p>Either: Web Feature First –When all the packages matching with the conditions specified in URL Access Control and Web Feature below, such function can determine the priority for the actions executed. For this one, the router will process the packages with the conditions set below for web feature first, then URL second.</p>  |
| <p>Log</p> | <p>None – There is no log file will be recorded for this profile. Pass – Only the log about Pass will be recorded in Syslog. Block – Only the log about Block will be recorded in Syslog. All – All the actions (Pass and Block) will be recorded in Syslog.</p>  |
| <p>URL Access Control</p> | <p>Enable URL Access Control - Check the box to activate URL Access Control. Note that the priority for URL Access Control is higher than Restrict Web Feature. If the web content match the setting set in URL Access Control, the router will execute the action specified in this field and ignore the action specified under Restrict Web Feature.</p> <p>Prevent web access from IP address - Check the box to deny any web surfing activity using IP address, such as http://202.6.3.2. The reason for this is to prevent someone dodges the URL Access Control. You must clear your browser cache first so that the URL content filtering facility operates properly on a web page that you visited before.</p> <p>Action – This setting is available only when Either : URL Access Control First or Either : Web Feature First is selected. Pass - Allow accessing into the corresponding webpage with the keywords listed on the box below. Block - Restrict accessing into the corresponding webpage with the keywords listed on the box below. If the web pages do not match with the keyword set here, it will be processed with reverse action.</p> <p>Action:</p>  <p>Group/Object Selections – The Vigor router provides several frames for users to define keywords and each frame</p> |

supports multiple keywords. The keyword could be a noun, a partial noun, or a complete URL string. Multiple keywords within a frame are separated by space, comma, or semicolon. In addition, the maximal length of each frame is 32-character long. After specifying keywords, the Vigor router will decline the connection request to the website whose URL string matched to any user-defined keyword. It should be noticed that the more simplified the blocking keyword list is, the more efficiently the Vigor router performs.

Object/Group Edit

| | |
|-------------------------|------|
| <u>Keyword Object</u> | None |
| or Keyword Object | None |
| or Keyword Object | None |
| or Keyword Object | None |
| or Keyword Object | None |
| or Keyword Object | None |
| or Keyword Object | None |
| or Keyword Object | None |
| or <u>Keyword Group</u> | None |
| or Keyword Group | None |
| or Keyword Group | None |
| or Keyword Group | None |
| or Keyword Group | None |
| or Keyword Group | None |
| or Keyword Group | None |
| or Keyword Group | None |
| or Keyword Group | None |

Web Feature

Enable Restrict Web Feature - Check this box to make the keyword being blocked or passed.

Action - This setting is available only when **Either: URL Access Control First** or **Either: Web Feature Firs** is selected. **Pass** allows accessing into the corresponding webpage with the keywords listed on the box below.

Pass - Allow accessing into the corresponding webpage with the keywords listed on the box below.

Block - Restrict accessing into the corresponding webpage with the keywords listed on the box below.

If the web pages do not match with the specified feature set here, it will be processed with reverse action.

Cookie - Check the box to filter out the cookie transmission from inside to outside world to protect the local user's privacy.

Proxy - Check the box to reject any proxy transmission. To control efficiently the limited-bandwidth usage, it will be of great value to provide the blocking mechanism that filters out the multimedia files downloading from web pages.

Upload - Check the box to block the file upload by way of web page.

File Extension Profile - Choose one of the profiles that you configured in **Object Setting>> File Extension**

Objects previously for passing or blocking the file downloading.

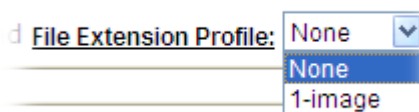

After finishing all the settings, please click **OK** to save the configuration.

3.6.3 Web Content Filter Profile

There are three ways to activate WCF on vigor router, using **Service Activation Wizard**, by means of **CSM>>Web Content Filter Profile** or via **System Maintenance>>Activation**.

Service Activation Wizard allows you to use trial version or update the license of WCF directly without accessing into the server (**MyVigor**) located on <http://myvigor.draytek.com>.

However, if you use the **Web Content Filter Profile** page to activate WCF feature, it is necessary for you to access into the server (**MyVigor**) located on <http://myvigor.draytek.com>. Therefore, you need to register an account on <http://myvigor.draytek.com> for using corresponding service. Please refer to section of creating MyVigor account.

Note: If you have used **Service Activation Wizard** to activate WCF service, you can skip this section.

WCF adopts the mechanism developed and offered by certain service provider (e.g., DrayTek). No matter activating WCF feature or getting a new license for web content filter, you have to click **Activate** to satisfy your request. Be aware that service provider matching with Vigor router currently offers a period of time for trial version for users to experiment. If you want to purchase a formal edition, simply contact with the channel partner or your dealer.

Click **CSM** and click **Web Content Filter Profile** to open the profile setting page. The default setting for Setup Query Server /Setup Test Server is **auto-selected**. You can choose another server for your necessity by clicking **Find more** to open <http://myvigor.draytek.com> for searching another qualified and suitable one.

Note 1: Web Content Filter (WCF) uses an external service powered by **Commtouch/Cyren**. If you want to use such service (trial or subscription), you have to activate the service first. For subscriptions, please contact your dealer.

Web-Filter License [Activate](#)
 [Status:Not Activated]

| | | |
|--------------------|--------------------------------------------|---------------------------|
| Setup Query Server | <input type="text" value="auto-selected"/> | Find more |
| Setup Test Server | <input type="text" value="auto-selected"/> | Find more |

Web Content Filter Profile Table: [Set to Factory Default](#)

| Profile | Name | Profile | Name |
|---------|---------|---------|------|
| 1. | Default | 5. | |
| 2. | | 6. | |
| 3. | | 7. | |
| 4. | | 8. | |

Administration Message (Max 255 characters) Cache :

```
<body><center><br><br><br><p>The requested Web page <br> from %SIP% <br>to %URL% <br>that is categorized with %CL% <br>has been blocked by %RNAME% Web Content Filter.<p>Please contact your system administrator for further information.</center></body>
```

Legend:
 %SIP% - Source IP , %DIP% - Destination IP , %URL% - URL
 %CL% - Category , %RNAME% - Router Name

Available settings are explained as follows:

| Item | Description |
|--------------------------------------------------------|--------------------------------------------------------------------------------------------------------------------------------------------------------------------------------------------------|
| Activate | Click it to access into MyVigor for activating WCF service. |
| Setup Query Server | It is recommended for you to use the default setting, auto-selected. You need to specify a server for categorize searching when you type URL in browser based on the web content filter profile. |
| Setup Test Server | It is recommended for you to use the default setting, auto-selected. |
| Find more | Click it to open http://myvigor.draytek.com for searching another qualified and suitable server. |
| Test a site to verify whether it is categorized | Click this link to do the verification. |
| Set to Factory Default | Click this link to retrieve the factory settings. |
| Default Message | You can type the message manually for your necessity or click this button to get the default message which will be displayed on the field of Administration Message . |

| | |
|--------------|-----------------------------------------------------------------------------------------------------------------------------------------------------------------------------------------------------------------------------------------------------------------------------------------------------------------------------------------------------------------------------------------------------------------------------------------------------------------------------------------------------------------------------------------------------------------------------------------------------------------------------------------------------------------------------------------------------------------------------------------------------------------------------------------------------------------------------------------------------------------------------------------------------------------------------------------------------------------------------------------------------------------------------------------------------------------------------------------------------------------|
| Cache | <p>None – the router will check the URL that the user wants to access via WCF precisely, however, the processing rate is normal. Such item can provide the most accurate URL matching.</p> <p>L1 – the router will check the URL that the user wants to access via WCF. If the URL has been accessed previously, it will be stored for a short time (about 1 second) in the router to be accessed quickly if required. Such item can provide accurate URL matching with faster rate.</p> <p>L2 – the router will check the URL that the user wants to access via WCF. If the data has been accessed previously, the IP addresses of source and destination IDs will be memorized for a short time (about 1 second) in the router. When the user tries to access the same destination ID, the router will check it by comparing the record stored. If it matches, the page will be retrieved quickly. Such item can provide URL matching with the fastest rate.</p> <p>L1+L2 Cache – the router will check the URL with fast processing rate combining the feature of L1 and L2.</p> |
|--------------|-----------------------------------------------------------------------------------------------------------------------------------------------------------------------------------------------------------------------------------------------------------------------------------------------------------------------------------------------------------------------------------------------------------------------------------------------------------------------------------------------------------------------------------------------------------------------------------------------------------------------------------------------------------------------------------------------------------------------------------------------------------------------------------------------------------------------------------------------------------------------------------------------------------------------------------------------------------------------------------------------------------------------------------------------------------------------------------------------------------------|

Eight profiles are provided here as Web content filters. Simply click the index number under Profile to open the following web page. The items listed in Categories will be changed according to the different service providers. If you have and activate another web content filter license, the items will be changed simultaneously. All of the configuration made for web content filter will be deleted automatically. Therefore, please backup your data before you change the web content filter license.

CSM >> Web Content Filter Profile

Profile Index: 1
Profile Name: Log:

Black/White List

Enable

Action: Group/Object Selections

Action:

| Groups | Categories | | |
|-----------------------------------------------------------------------------------------------------------|--------------------------------------------------------|-------------------------------------------------------|-----------------------------------------------|
| Child Protection <input type="button" value="Select All"/> <input type="button" value="Clear All"/> | <input checked="" type="checkbox"/> Alcohol & Tobacco | <input checked="" type="checkbox"/> Criminal Activity | <input checked="" type="checkbox"/> Gambling |
| | <input checked="" type="checkbox"/> Hate & Intolerance | <input checked="" type="checkbox"/> Illegal Drug | <input checked="" type="checkbox"/> Nudity |
| | <input checked="" type="checkbox"/> Porn & Sexually | <input checked="" type="checkbox"/> Violence | <input checked="" type="checkbox"/> Weapons |
| | <input checked="" type="checkbox"/> School Cheating | <input checked="" type="checkbox"/> Sex Education | <input checked="" type="checkbox"/> Tasteless |

| Categories | Categories | Categories |
|-----------------------------------------------|----------------------------------------------|-----------------------------------------|
| <input type="checkbox"/> News | <input type="checkbox"/> Non-profits & NGOs | <input type="checkbox"/> Personal Sites |
| <input type="checkbox"/> Politics | <input type="checkbox"/> Real Estate | <input type="checkbox"/> Religion |
| <input type="checkbox"/> Restaurants & Dining | <input type="checkbox"/> Shopping | <input type="checkbox"/> Translators |
| <input type="checkbox"/> General | <input type="checkbox"/> Cults | <input type="checkbox"/> Greeting cards |
| <input type="checkbox"/> Image Sharing | <input type="checkbox"/> Network Errors | <input type="checkbox"/> Parked Domains |
| <input type="checkbox"/> Private IP Addresses | <input type="checkbox"/> Uncategorised Sites | |

Available settings are explained as follows:

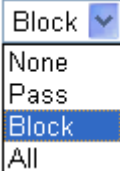
| Item | Description |
|-------------------------|-----------------------------------------------------------------------------------------------------------------------------------------------------------------------------------------------------------------------------------------------------------------------------------------------------------------------------------------------------------------------------------------------------------------------------------------------------------------------------------------------------------------------------------------------------------------------------------------------------------------------------------------------------------------------------------------------------------------------------------------------------------------------|
| Profile Name | Type a name for the CSM profile. The maximum length of the name you can set is 15 characters. |
| Black/White List | <p>Enable – Activate white/black list function for such profile.</p> <p>Group/Object Selections – Click Edit to choose the group or object profile as the content of white/black list.</p> <p>Pass - allow accessing into the corresponding webpage with the characters listed on Group/Object Selections. If the web pages do not match with the specified feature set here, they will be processed with the categories listed on the box below.</p> <p>Block - restrict accessing into the corresponding webpage with the characters listed on Group/Object Selections. If the web pages do not match with the specified feature set here, they will be processed with the categories listed on the box below.</p> |
| Action | <p>Pass - allow accessing into the corresponding webpage with the categories listed on the box below.</p> <p>Block - restrict accessing into the corresponding webpage with the categories listed on the box below.</p> <p>If the web pages do not match with the specified feature set here, it will be processed with reverse action.</p> |
| Log | <p>None – There is no log file will be recorded for this profile.</p> <p>Pass – Only the log about Pass will be recorded in Syslog.</p> <p>Block – Only the log about Block will be recorded in Syslog.</p> <p>All – All the actions (Pass and Block) will be recorded in Syslog.</p>  |

After finishing all the settings, please click **OK** to save the configuration.

3.6.4 DNS Filter

The DNS Filter monitors DNS queries on UDP port 53 and will pass the DNS query information to the WCF to help with categorizing HTTPS URL's.

Note: For DNS filter must use the WCF service profile to filter the packets, therefore WCF license must be activated first. Otherwise, DNS filter does not have any effect on packets.

CSM >> DNS Filter

DNS Filter

DNS Filter Enable

Syslog None

Service None

Cache Time(hour) 1

Administration Message (Max 255 characters) Default Message

```
<body><center><br><br><br><p>The requested Web page <br> from %SIP% <br>to %URL%
<br>that is categorized with %CL% <br>has been blocked by %RNAME% DNS Filter.<p>Please
contact your system administrator for further information.</center></body>
```

Legend:
 %SIP% - Source IP , %URL% - URL
 %CL% - Category , %RNAME% - Router Name

OK
Cancel

Available settings are explained as follows:

| Item | Description |
|------------|---------------------------------------------------------------------------------------------------------------------------------------------------------------------------------------------------------------------------------------------------------------------------------------------------------------------------------------------------------------------------------------------------------------------------------------------------------------------------------------------------------------------------------------------------------------------------------------------------------------------------------------------------------|
| DNS Filter | Check Enable to enable such feature. |
| Syslog | <p>The filtering result can be recorded according to the setting selected for Syslog.</p> <p>None – There is no log file will be recorded for this profile.</p> <p>Pass – Only the log about Pass will be recorded in Syslog.</p> <p>Block – Only the log about Block will be recorded in Syslog.</p> <p>All – All the actions (Pass and Block) will be recorded in Syslog.</p> <div style="border: 1px solid gray; padding: 5px; margin-top: 10px;"> Block <div style="border: 1px solid gray; padding: 2px;"> None Pass Block All </div> </div> |

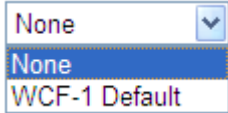
| | |
|-------------------------------|------------------------------------------------------------------------------------------------------------------------------------------------------------------------------------------------------------------------|
| Service | <p>Set the filtering conditions. Specify one of the WCF profiles as Service.</p>  <p>Choose the WCF profiles to apply DNS filter.</p> |
| Cache Time (hour) | Set the time for DNS query. |
| Administration Message | Type the words or sentences which will be displayed when a web page is blocked by Vigor router. |

After finishing all the settings, please click **OK** to save the configuration.

3.7 Bandwidth Management

Below shows the menu items for Bandwidth Management.



3.7.1 Sessions Limit

A PC with private IP address can access to the Internet via NAT router. The router will generate the records of NAT sessions for such connection. The P2P (Peer to Peer) applications (e.g., BitTorrent) always need many sessions for procession and also they will occupy over resources which might result in important accesses impacted. To solve the problem, you can use limit session to limit the session procession for specified Hosts.

In the **Bandwidth Management** menu, click **Sessions Limit** to open the web page.

Bandwidth Management >> Sessions Limit

Sessions Limit

Enable
 Disable

Default Max Sessions:

Limitation List

| Index | Start IP | End IP | Max Sessions |
|-------|----------|--------|--------------|
| | | | |

Specific Limitation

Start IP: End IP:

Maximum Sessions:

Administration Message (Max 256 characters)

Time Schedule

Index(1-15) in Schedule Setup: , , ,

Note: Action and Idle Timeout settings will be ignored.

To activate the function of limit session, simply click **Enable** and set the default session limit. Available settings are explained as follows:

| Item | Description |
|----------------------|------------------------------------------------------------------------------|
| Session Limit | Enable - Click this button to activate the function of limit session. |

| | |
|-------------------------------|------------------------------------------------------------------------------------------------------------------------------------------------------------------------------------------------------------------------------------------------------------------------------------------------------------------------------------------------------------------------------------------------------------------------------------------------------------------------------------------------------------------------------------------------------------------------------------------------------------------------------------------------------------------------------------|
| | <p>Disable - Click this button to close the function of limit session.</p> <p>Default session limit - Defines the default session number used for each computer in LAN.</p> |
| Limitation List | Displays a list of specific limitations that you set on this web page. |
| Specific Limitation | <p>Start IP- Defines the start IP address for limit session.</p> <p>End IP - Defines the end IP address for limit session.</p> <p>Maximum Sessions - Defines the available session number for each host in the specific range of IP addresses. If you do not set the session number in this field, the system will use the default session limit for the specific limitation you set for each index.</p> <p>Add - Adds the specific session limitation onto the list above.</p> <p>Edit - Allows you to edit the settings for the selected limitation.</p> <p>Delete - Remove the selected settings existing on the limitation list.</p> |
| Administration Message | <p>Type the words which will be displayed when reaches the maximum number of Internet sessions permitted.</p> <p>Default Message - Click this button to apply the default message offered by the router.</p> |
| Time Schedule | Index (1-15) in Schedule Setup - You can type in four sets of time schedule for your request. All the schedules can be set previously in Application >> Schedule web page and you can use the number that you have set in that web page. |

After finishing all the settings, please click **OK** to save the configuration.

3.7.2 Bandwidth Limit

The downstream or upstream from FTP, HTTP or some P2P applications will occupy large of bandwidth and affect the applications for other programs. Please use Limit Bandwidth to make the bandwidth usage more efficient.

In the **Bandwidth Management** menu, click **Bandwidth Limit** to open the web page.

Bandwidth Management >> Bandwidth Limit

Bandwidth Limit

Enable
 Disable

Default TX Limit: Kbps
 Default RX Limit: Kbps

Allow auto adjustment to make the best utilization of available bandwidth.

Limitation List

| Index | Start IP | End IP | TX limit | RX limit | Shared |
|-------|----------|--------|----------|----------|--------|
| | | | | | |

Specific Limitation

Start IP: End IP:

Each
 Shared
 TX Limit: Kbps
 RX Limit: Kbps

Smart Bandwidth Limit

For any LAN IP Not in Limitation List, when session number exceeds

TX Limit : Kbps
 RX Limit : Kbps

Note : For TX/RX, a setting of "0" means unlimited bandwidth.

Time Schedule

Index(1-15) in Schedule Setup: , , ,

Note: Action and Idle Timeout settings will be ignored.

To activate the function of limit bandwidth, simply click **Enable** and set the default upstream and downstream limit.

Available settings are explained as follows:

| Item | Description |
|------------------------|--------------------------------------------------------------------------------------------------------------------------------------------------------------------------------------------------------------------------------------------------------------------------------------------------------------------------------------------------------------------------------------------------------------------------------------------------------|
| Bandwidth Limit | <p>Enable - Click this button to activate the function of limit bandwidth.</p> <p>Disable - Click this button to close the function of limit bandwidth.</p> <p>Default TX limit - Define the default speed of the upstream for each computer in LAN.</p> <p>Default RX limit - Define the default speed of the downstream for each computer in LAN.</p> <p>Allow auto adjustment...- Check this box to make the</p> |

| | |
|------------------------------|-----------------------------------------------------------------------------------------------------------------------------------------------------------------------------------------------------------------------------------------------------------------------------------------------------------------------------------------------------------------------------------------------------------------------------------------------------------------------------------------------------------------------------------------------------------------------------------------------------------------------------------------------------------------------------------------------------------------------------------------------------------------------------------------------------------------------------------------------------------------------------------------------------------------------------------------------------------------------------------------------------------------------------------------------------------------------------------------------------------------------------------------------------------|
| | best utilization of available bandwidth. |
| Limitation List | Display a list of specific limitations that you set on this web page. |
| Specific Limitation | <p>Start IP - Define the start IP address for limit bandwidth.</p> <p>End IP - Define the end IP address for limit bandwidth.</p> <p>Each /Shared - Select Each to make each IP within the range of Start IP and End IP having the same speed defined in TX limit and RX limit fields; select Shared to make all the IPs within the range of Start IP and End IP share the speed defined in TX limit and RX limit fields.</p> <p>TX limit - Define the limitation for the speed of the upstream. If you do not set the limit in this field, the system will use the default speed for the specific limitation you set for each index.</p> <p>RX limit - Define the limitation for the speed of the downstream. If you do not set the limit in this field, the system will use the default speed for the specific limitation you set for each index.</p> <p>Add - Add the specific speed limitation onto the list above.</p> <p>Edit - Allow you to edit the settings for the selected limitation.</p> <p>Delete - Remove the selected settings existing on the limitation list.</p> |
| Smart Bandwidth Limit | <p>Check this box to have the bandwidth limit determined by the system automatically.</p> <p>TX limit - Define the limitation for the speed of the upstream. If you do not set the limit in this field, the system will use the default speed for the specific limitation you set for each index.</p> <p>RX limit - Define the limitation for the speed of the downstream. If you do not set the limit in this field, the system will use the default speed for the specific limitation you set for each index.</p> |
| Time Schedule | Index (1-15) in Schedule Setup - You can type in four sets of time schedule for your request. All the schedules can be set previously in Application >> Schedule web page and you can use the number that you have set in that web page. |

3.7.3 Quality of Service

Deploying QoS (Quality of Service) management to guarantee that all applications receive the service levels required and sufficient bandwidth to meet performance expectations is indeed one important aspect of modern enterprise network.

One reason for QoS is that numerous TCP-based applications tend to continually increase their transmission rate and consume all available bandwidth, which is called TCP slow start. If other applications are not protected by QoS, it will detract much from their performance in the overcrowded network. This is especially essential to those are low tolerant of loss, delay or jitter (delay variation).

Another reason is due to congestions at network intersections where speeds of interconnected circuits mismatch or traffic aggregates, packets will queue up and traffic can be throttled back to a lower speed. If there's no defined priority to specify which packets should be discarded (or in another term "dropped") from an overflowing queue, packets of sensitive applications mentioned above might be the ones to drop off. How this will affect application performance?

There are two components within Primary configuration of QoS deployment:

- **Classification:** Identifying low-latency or crucial applications and marking them for high-priority service level enforcement throughout the network.
- **Scheduling:** Based on classification of service level to assign packets to queues and associated service types

The basic QoS implementation in Vigor routers is to classify and schedule packets based on the service type information in the IP header. For instance, to ensure the connection with the headquarter, a teleworker may enforce an index of QoS Control to reserve bandwidth for HTTPS connection while using lots of application at the same time.

One more larger-scale implementation of QoS network is to apply DSCP (Differentiated Service Code Point) and IP Precedence disciplines at Layer 3. Compared with legacy IP Precedence that uses Type of Service (ToS) field in the IP header to define 8 service classes, DSCP is a successor creating 64 classes possible with backward IP Precedence compatibility. In a QoS-enabled network, or Differentiated Service (DiffServ or DS) framework, a DS domain owner should sign a Service License Agreement (SLA) with other DS domain owners to define the service level provided toward traffic from different domains. Then each DS node in these domains will perform the priority treatment. This is called per-hop-behavior (PHB). The definition of PHB includes Expedited Forwarding (EF), Assured Forwarding (AF), and Best Effort (BE). AF defines the four classes of delivery (or forwarding) classes and three levels of drop precedence in each class.

Vigor routers as edge routers of DS domain shall check the marked DSCP value in the IP header of bypassing traffic, thus to allocate certain amount of resource execute appropriate policing, classification or scheduling. The core routers in the backbone will do the same checking before executing treatments in order to ensure service-level consistency throughout the whole QoS-enabled network.

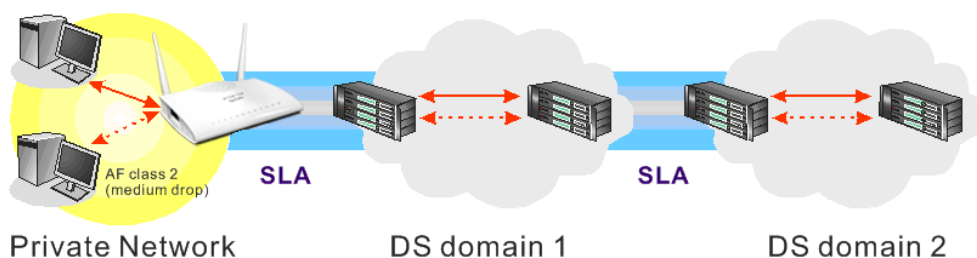

However, each node may take different attitude toward packets with high priority marking since it may bind with the business deal of SLA among different DS domain owners. It's not easy to achieve deterministic and consistent high-priority QoS traffic throughout the whole network with merely Vigor router's effort.

In the **Bandwidth Management** menu, click **Quality of Service** to open the web page.

Bandwidth Management >> Quality of Service

| General Setup | | | | | | | | | | Set to Factory Default |
|---------------|---------|-----------------------|-----------|---------|---------|---------|--------|-----------------------|-------------------|----------------------------------------|
| Index | Status | Bandwidth | Direction | Class 1 | Class 2 | Class 3 | Others | UDP Bandwidth Control | Online Statistics | |
| WAN1 | Disable | --Kbps/--Kbps | | 25% | 25% | 25% | 25% | Inactive | Status | Setup |
| WAN2 | Disable | 100000Kbps/100000Kbps | | 25% | 25% | 25% | 25% | Inactive | Status | Setup |
| WAN3 | Disable | 100000Kbps/100000Kbps | | 25% | 25% | 25% | 25% | Inactive | Status | Setup |

| Class Rule | | | |
|------------|------|----------------------|----------------------|
| Index | Name | Rule | Service Type |
| Class 1 | | Edit | |
| Class 2 | | Edit | Edit |
| Class 3 | | Edit | |

Enable the First Priority for VoIP SIP/RTP:
 SIP UDP Port: (Default:5060)

Available settings are explained as follows:

| Item | Description |
|----------------------------------|--------------------------------------------------------------------------------------------------------------------------------------------------------------------------------------------------------------------------------------------------------------------------------------------------------------------------------------------------------------------------------------------------------------------------------------------------------------------------------------------------------------------------------------------------------------------------------------------------------------------------------------------------------------------------------------------------------------------------------------------------|
| General Setup | <p>Index - Display the WAN interface number that you can edit.</p> <p>Status - Display if the WAN interface is available for such function or not.</p> <p>Bandwidth - Display the inbound and outbound bandwidth setting for the WAN interface.</p> <p>Direction - Display which direction that such function will influence.</p> <p>Class 1/Class2/Class 3/Others - Display the bandwidth percentage for each class.</p> <p>UDP Bandwidth Control - Display the UDP bandwidth control is enabled or not.</p> <p>Online Statistics - Display an online statistics for quality of service for your reference</p> <p>Setup - Allow to configure general QoS setting for WAN interface.</p> |
| Class Rule | <p>Index - Display the class number that you can edit.</p> <p>Name - Display the name of the class.</p> <p>Rule - Allow to configure detailed settings for the selected Class.</p> <p>Service Type - Allow to configure detailed settings for the service type.</p> |
| Enable the First Priority | When this feature is enabled, the VoIP SIP/UDP packets will |

| Item | Description |
|------------------|-----------------------------------------------------------------------------------------|
| for VoIP SIP/RTP | be sent with highest priority. SIP UDP Port – Set a port number used for SIP. |

This page displays the QoS settings result of the WAN interface. Click the **Setup** link to access into next page for the general setup of WAN interface. As to class rule, simply click the **Edit** link to access into next for configuration.

You can configure general setup for the WAN interface, edit the Class Rule, and edit the Service Type for the Class Rule for your request.

Online Statistics

Display an online statistics for quality of service for your reference. This feature is available only when the Quality of Service for WAN interface is enabled.

Bandwidth Management >> Quality of Service

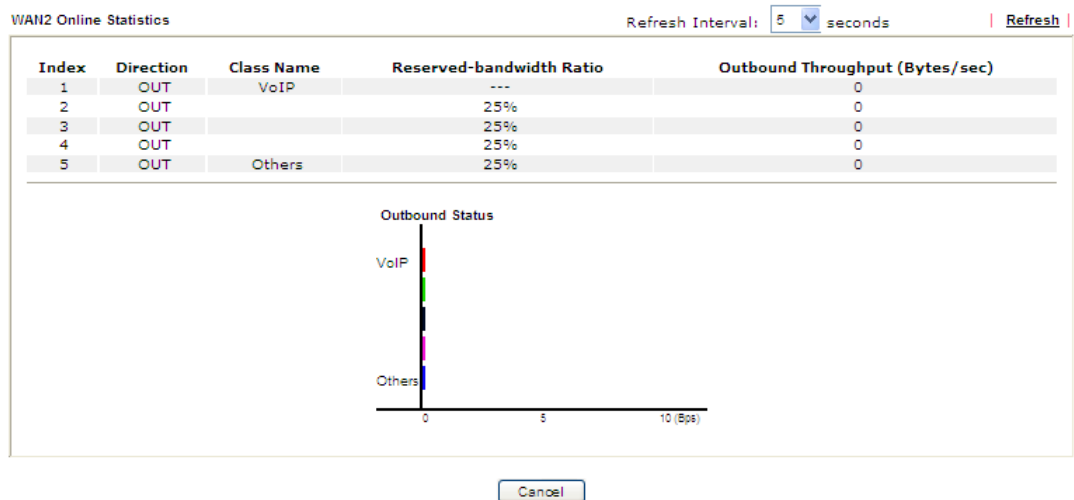

General Setup for WAN Interface

When you click **Setup**, you can configure the bandwidth ratio for QoS of the WAN interface. There are four queues allowed for QoS control. The first three (Class 1 to Class 3) class rules can be adjusted for your necessity. Yet, the last one is reserved for the packets which are not suitable for the user-defined class rules.

WAN2 General Setup

Enable the QoS Control OUT

| WAN Inbound Bandwidth | <input type="text" value="100"/> | <input type="radio"/> Kbps | <input checked="" type="radio"/> Mbps | |
|-------------------------------------------------------|----------------------------------|-----------------------------------------------------------|---------------------------------------|--|
| WAN Outbound Bandwidth | <input type="text" value="100"/> | <input type="radio"/> Kbps | <input checked="" type="radio"/> Mbps | |
| Index | Class Name | Reserved_bandwidth Ratio | | |
| Class 1 | | <input type="text" value="25"/> | % | |
| Class 2 | | <input type="text" value="25"/> | % | |
| Class 3 | | <input type="text" value="25"/> | % | |
| | Others | <input type="text" value="25"/> | % | |
| <input type="checkbox"/> Enable UDP Bandwidth Control | | Limited_bandwidth Ratio <input type="text" value="25"/> % | | |
| <input type="checkbox"/> Outbound TCP ACK Prioritize | | | | |

Note:1.Before enable QoS, you should test the real bandwidth first. QoS may not work properly if the bandwidth is not accurate.

2.You can do speed test by <http://speedtest.net> or contact with your ISP for speed test program.

Available settings are explained as follows:

| Item | Description |
|-------------------------------------|---------------------------------------------------------------------------------------------------------------------------------------------------------------------------------------------------------------------------------------------------------------------------------------------------------------------------------------------------------------------------------------------------------------------------------------------------------------------|
| Enable the QoS Control | <p>The factory default for this setting is checked.</p> <p>Please also define which traffic the QoS Control settings will apply to.</p> <p>IN- apply to incoming traffic only.</p> <p>OUT- apply to outgoing traffic only.</p> <p>BOTH- apply to both incoming and outgoing traffic.</p> <p>Check this box and click OK, then click Setup link again. You will see the Online Statistics link appearing on this page.</p> |
| WAN Inbound Bandwidth | It allows you to set the connecting rate of data input for WAN2/WAN3. For example, if your ADSL supports 1M of downstream and 256K upstream, please set 1000kbps for this box. The default value is 10000kbps. |
| WAN Outbound Bandwidth | It allows you to set the connecting rate of data output for WAN2/WAN3. For example, if your ADSL supports 1M of downstream and 256K upstream, please set 256kbps for this box. The default value is 10000kbps. |
| Reserved Bandwidth Ratio | It is reserved for the group index in the form of ratio of reserved bandwidth to upstream speed and reserved bandwidth to downstream speed . |
| Enable UDP Bandwidth Control | Check this and set the limited bandwidth ratio on the right field. This is a protection of TCP application traffic since UDP application traffic such as streaming video will exhaust lots of bandwidth. |

| | |
|------------------------------------|-----------------------------------------------------------------------------------------------------------------------------------------------------------------------------------------------------------------------------------------------|
| Outbound TCP ACK Prioritize | The difference in bandwidth between download and upload are great in ADSL2+ environment. For the download speed might be impacted by the uploading TCP ACK, you can check this box to push ACK of upload faster to speed the network traffic. |
| Limited_bandwidth Ratio | The ratio typed here is reserved for limited bandwidth of UDP application. |

Note: The rate of outbound/inbound must be smaller than the real bandwidth to ensure correct calculation of QoS. It is suggested to set the bandwidth value for inbound/outbound as 80% - 85% of physical network speed provided by ISP to maximize the QoS performance.

Edit the Class Rule for QoS

- The first three (Class 1 to Class 3) class rules can be adjusted for your necessity. To add, edit or delete the class rule, please click the **Edit** link of that one.

Bandwidth Management >> Quality of Service

General Setup | [Set to Factory Default](#) |

| Index | Status | Bandwidth | Direction | Class 1 | Class 2 | Class 3 | Others | UDP Bandwidth Control | Online Statistics |
|-------|---------|-----------------------|-----------|---------|---------|---------|--------|-----------------------|------------------------------|
| WAN1 | Disable | --Kbps/--Kbps | | 25% | 25% | 25% | 25% | Inactive | Status Setup |
| WAN2 | Disable | 100000Kbps/100000Kbps | | 25% | 25% | 25% | 25% | Inactive | Status Setup |
| WAN3 | Disable | 100000Kbps/100000Kbps | | 25% | 25% | 25% | 25% | Inactive | Status Setup |

Class Rule

| Index | Name | Rule | Service Type |
|---------|------|----------------------|----------------------|
| Class 1 | | Edit | |
| Class 2 | | Edit | Edit |
| Class 3 | | Edit | |

Enable the First Priority for VoIP SIP/RTP:
 SIP UDP Port: (Default:5060)

- After you click the **Edit** link, you will see the following page. Now you can define the name for that Class. In this case, "Test" is used as the name of Class Index #1.

Bandwidth Management >> Quality of Service

Class Index #1

Name Tag packets as:

| NO | Status | Local Address | Remote Address | DiffServ CodePoint | Service Type |
|----|--------|---------------|----------------|--------------------|--------------|
| 1 | Empty | - | - | - | - |

3. For adding a new rule, click **Add** to open the following page.

Bandwidth Management >> Quality of Service

Rule Edit

| | |
|-----------------------------------------------------------------|------------------------------------------------------------------|
| <input checked="" type="checkbox"/> ACT | |
| Ethernet Type | <input checked="" type="radio"/> IPv4 <input type="radio"/> IPv6 |
| Local Address | Any <input type="button" value="Edit"/> |
| Remote Address | Any <input type="button" value="Edit"/> |
| DiffServ CodePoint | ANY <input type="button" value="v"/> |
| Service Type | ---Predefined--- <input type="button" value="v"/> |
| Note: Please choose/setup the Service Type first. | |

Available settings are explained as follows:

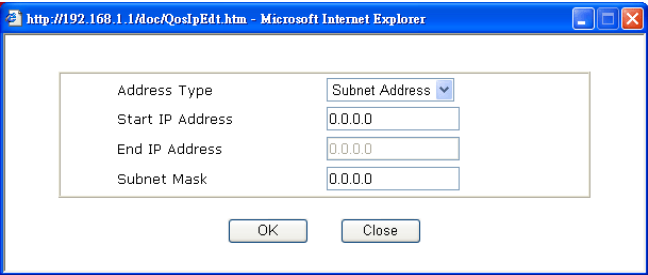
| Item | Description |
|---------------------------|---------------------------------------------------------------------------------------------------------------------------------------------------------------------------------------------------------------------------------------------------------------------------------------------------------------------------|
| ACT | Check this box to invoke these settings. |
| Ethernet Type | Please specify which protocol (IPv4 or IPv6) will be used for this rule. |
| Local Address | Click the Edit button to set the local IP address (on LAN) for the rule. |
| Remote Address | Click the Edit button to set the remote IP address (on LAN/WAN) for the rule.  |
| | Address Type – Determine the address type for the source address. For Single Address , you have to fill in Start IP address. For Range Address , you have to fill in Start IP address and End IP address. For Subnet Address , you have to fill in Start IP address and Subnet Mask. |
| DiffServ CodePoint | All the packets of data will be divided with different levels and will be processed according to the level type by the system. Please assign one of the levels of the data for processing with QoS control. |
| Service Type | It determines the service type of the data for processing with QoS control. It can also be edited. You can choose the predefined service type from the Service Type drop down list. Those types are predefined in factory. Simply choose the one that you want for using by current QoS. |

4. After finishing all the settings here, please click **OK** to save the configuration.

By the way, you can set up to 20 rules for one Class. If you want to edit an existed rule, please select the radio button of that one and click **Edit** to open the rule edit page for modification.

Bandwidth Management >> Quality of Service

Class Index #1

Name Tag packets as:

| NO | Status | Local Address | Remote Address | DiffServ CodePoint | Service Type |
|-------------------------|--------|---------------|----------------|--------------------|--------------|
| 1 <input type="radio"/> | Active | Any | Any | ANY | ANY |

Edit the Service Type for Class Rule

1. To add a new service type, edit or delete an existed service type, please click the Edit link under Service Type field.

Bandwidth Management >> Quality of Service

General Setup

[Set to Factory Default](#)

| Index | Status | Bandwidth | Direction | Class 1 | Class 2 | Class 3 | Others | UDP Bandwidth Control | Online Statistics |
|-------|---------|-----------------------|-----------|---------|---------|---------|--------|-----------------------|------------------------------|
| WAN1 | Disable | --Kbps/--Kbps | | 25% | 25% | 25% | 25% | Inactive | Status Setup |
| WAN2 | Disable | 100000Kbps/100000Kbps | | 25% | 25% | 25% | 25% | Inactive | Status Setup |
| WAN3 | Disable | 100000Kbps/100000Kbps | | 25% | 25% | 25% | 25% | Inactive | Status Setup |

Class Rule

| Index | Name | Rule | Service Type |
|---------|------|----------------------|----------------------|
| Class 1 | Test | Edit | Edit |
| Class 2 | | Edit | |
| Class 3 | | Edit | |

Enable the First Priority for VoIP SIP/RTP:
 SIP UDP Port: (Default: 5060)

2. After you click the **Edit** link, you will see the following page.

Bandwidth Management >> Quality of Service

User Defined Service Type

| NO | Name | Protocol | Port |
|----|-------|----------|------|
| 1 | Empty | - | - |

- For adding a new service type, click **Add** to open the following page.

Bandwidth Management >> Quality of Service

Service Type Edit

| | |
|--------------------|---------------------------------------------------------------------|
| Service Name | <input type="text"/> |
| Service Type | TCP <input type="button" value="v"/> <input type="text" value="6"/> |
| Port Configuration | |
| Type | <input checked="" type="radio"/> Single <input type="radio"/> Range |
| Port Number | <input type="text" value="0"/> - <input type="text" value="0"/> |

Available settings are explained as follows:

| Item | Description |
|---------------------------|-------------------------------------------------------------------------------------------------------------------------------------------------------------------------------------------------------------------------------------------------------------------------------------------------------------------------------------------|
| Service Name | Type in a new service for your request. The maximum length of the name you can set is 11 characters. |
| Service Type | Choose the type (TCP, UDP or TCP/UDP or other) for the new service. |
| Port Configuration | <p>Type - Click Single or Range as the Type. If you select Range, you have to type in the starting port number and the end porting number on the boxes below.</p> <p>Port Number – Type in the starting port number and the end porting number here if you choose Range as the type.</p> |

- After finishing all the settings here, please click **OK** to save the configuration.

By the way, you can set up to 10 service types. If you want to edit/delete an existed service type, please select the radio button of that one and click **Edit/Edit** for modification.

Retag the Packets for Identification

Packets coming from LAN IP can be retagged through QoS setting. When the packets sent out through WAN interface, all of them will be tagged with certain header and that will be easily to be identified by server on ISP.

For example, in the following illustration, the VoIP packets in LAN go into Vigor router without any header. However, when they go forward to the Server on ISP through Vigor router, all of the packets are tagged with AF (configured in Bandwidth >>QoS>>Class) automatically.

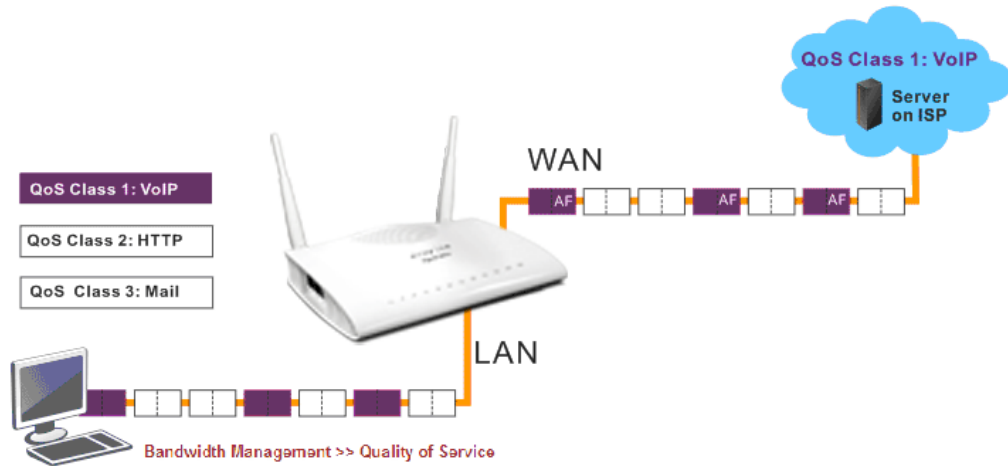

Class Index #1
Name Tag packets as:

| NO | Status | Local Address | Remote Address | DiffServ CodePoint | Service Type |
|----|--------|---------------|----------------|--------------------|--------------|
| 1 | Active | Any | Any | ANY | ANY |

3.7.4 APP QoS

The QoS function is used to do bandwidth management for the services with certain IP or port number. However, there is no effect of bandwidth management on the service such as VNC or PPTV without fixed IP or port number.

APP QoS employs the function of APP Enforcement to detect the types of software in application layer. By combining the function of QoS (adjustment on Inbound/Outbound bandwidth and bandwidth ratio), Vigor router can perform the bandwidth management for the protocols, streaming, remote control, web HD and so on.

Click **Bandwidth Management>>APP QoS** to open the following page.

Bandwidth Management >> APP QoS

APP QoS

Enable Disable

Traceable **Untraceable**

 Apply to all: QoS Class 1 (High)

| Enable | Protocol | Action |
|--------------------------|----------|----------------------|
| <input type="checkbox"/> | DNS | QoS Other (Lowest) ▼ |
| <input type="checkbox"/> | FTP | QoS Other (Lowest) ▼ |
| <input type="checkbox"/> | HTTP | QoS Other (Lowest) ▼ |
| <input type="checkbox"/> | IMAP | QoS Other (Lowest) ▼ |
| <input type="checkbox"/> | IRC | QoS Other (Lowest) ▼ |
| <input type="checkbox"/> | NNTP | QoS Other (Lowest) ▼ |
| <input type="checkbox"/> | POP3 | QoS Other (Lowest) ▼ |
| <input type="checkbox"/> | SMB | QoS Other (Lowest) ▼ |
| <input type="checkbox"/> | SMTP | QoS Other (Lowest) ▼ |
| <input type="checkbox"/> | SNMP | QoS Other (Lowest) ▼ |
| <input type="checkbox"/> | SSH | QoS Other (Lowest) ▼ |
| <input type="checkbox"/> | SSL/TLS | QoS Other (Lowest) ▼ |
| <input type="checkbox"/> | TELNET | QoS Other (Lowest) ▼ |

Note: Please remember to adjust Inbound/Outbound bandwidth of your network in "Quality of Service". This will help QoS to work more efficient.

Available settings are explained as follows:

| Item | Description |
|-----------------------|--------------------------------------------------------------------------------------------------------------------------------------|
| Enable/Disable | Click Enable to activate APP QoS function. Click Disable to deactivate APP QoS function. |
| Traceable | The protocol listed below is traceable by Vigor router. Each tab offers different types of protocols to fit your request. |
| Untraceable | The protocol listed below is not easy to trace by Vigor router. Each tab offers different types of protocols to fit your request. |
| Select All | Click it to select all of the protocols. |

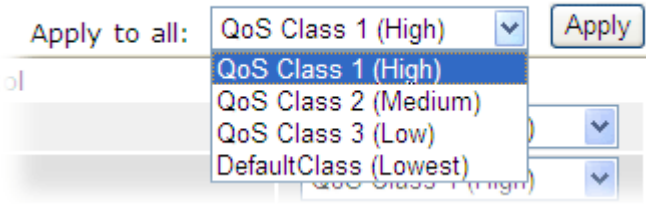
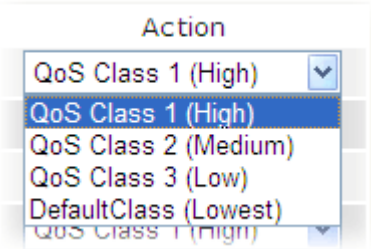
| | |
|---------------------|-------------------------------------------------------------------------------------------------------------------------------------------------------------------------------------------------------------------------------------------------------------------------------------------------------------|
| Clear All | Click it to de-select all of the protocols. |
| Apply to all | <p>Choose one of the actions from the drop down list. It is prepared for applying to all protocols.</p>  <p>Apply – Click it to make the selected action be applied all of the selected protocols immediately.</p> |
| Action | <p>There are many protocols which can be specified with different QoS Class.</p>  |

After finishing all the settings here, please click **OK** to save the configuration.

3.8 Applications

Below shows the menu items for Applications.



3.8.1 Dynamic DNS

The ISP often provides you with a dynamic IP address when you connect to the Internet via your ISP. It means that the public IP address assigned to your router changes each time you access the Internet. The Dynamic DNS feature lets you assign a domain name to a dynamic WAN IP address. It allows the router to update its online WAN IP address mappings on the specified Dynamic DNS server. Once the router is online, you will be able to use the registered domain name to access the router or internal virtual servers from the Internet. It is particularly helpful if you host a web server, FTP server, or other server behind the router.

Before you use the Dynamic DNS feature, you have to apply for free DDNS service to the DDNS service providers. The router provides up to three accounts from three different DDNS service providers. Basically, Vigor routers are compatible with the DDNS services supplied by most popular DDNS service providers such as www.dyndns.org, www.no-ip.com, www.dtdns.com, www.changeip.com, www.dynamic-nameserver.com. You should visit their websites to register your own domain name for the router.

Enable the Function and Add a Dynamic DNS Account

1. Assume you have a registered domain name from the DDNS provider, say *hostname.dyndns.org*, and an account with username: *test* and password: *test*.
2. In the DDNS setup menu, check **Enable Dynamic DNS Setup**.

Applications >> Dynamic DNS Setup

Dynamic DNS Setup | [Set to Factory Default](#) |

Enable Dynamic DNS Setup [View Log](#) [Force Update](#)

Auto-Update interval Min(s) (1~14400)

Accounts:

| Index | Domain Name | Active |
|-----------|-------------|--------|
| <u>1.</u> | | x |
| <u>2.</u> | | x |
| <u>3.</u> | | x |

[OK](#) [Clear All](#)

Available settings are explained as follows:

| Item | Description |
|---------------------------------|-----------------------------------------------------------------------------------------------|
| Set to Factory Default | Clear all profiles and recover to factory settings. |
| Enable Dynamic DNS Setup | Check this box to enable DDNS function. |
| Auto-Update interval | Set the time for the router to perform auto update for DDNS service. |
| View Log | Display DDNS log status. |
| Force Update | Force the router updates its information to DDNS server. |
| Index | Click the number below Index to access into the setting page of DDNS setup to set account(s). |
| Domain Name | Display the domain name that you set on the setting page of DDNS setup. |
| Active | Display if this account is active or inactive. |

- Select Index number 1 to add an account for the router. Check **Enable Dynamic DNS Account**, and choose correct Service Provider: dyndns.org, type the registered hostname: *hostname* and domain name suffix: dyndns.org in the **Domain Name** block. The following two blocks should be typed your account Login Name: *test* and Password: *test*.

Applications >> Dynamic DNS Setup >> Dynamic DNS Account Setup

Index : 1

Enable Dynamic DNS Account
 Service Provider:
 Service Type:
 Domain Name: .
 Login Name: (max. 64 characters)
 Password: (max. 23 characters)
 Wildcards
 Backup MX
 Mail Extender:
 Determine Real WAN IP:

Available settings are explained as follows:

| Item | Description |
|-----------------------------------|----------------------------------------------------------------------------------------------------------------------------------------------------------------------|
| Enable Dynamic DNS Account | Check this box to enable the current account. If you did check the box, you will see a check mark appeared on the Active column of the previous web page in step 2). |
| Service Provider | Select the service provider for the DDNS account. |
| Service Type | Select a service type (Dynamic, Custom or Static). If you choose Custom, you can modify the domain that is chosen in the Domain Name field. |

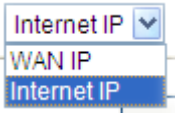
| Item | Description |
|-------------------------------|----------------------------------------------------------------------------------------------------------------------------------------------------------------------------------------------------------------------------------------------------------------------------------------------------------------------------------------------------------------------------------------------------------------------------------------------------------------------------------------------------------------------------------------------------------------------------------------------------------------------------------------------------------------------------------------------------------------------------------|
| Domain Name | Type in one domain name that you applied previously. Use the drop down list to choose the desired domain. |
| Login Name | Type in the login name that you set for applying domain. |
| Password | Type in the password that you set for applying domain. |
| Wildcard and Backup MX | The Wildcard and Backup MX (Mail Exchange) features are not supported for all Dynamic DNS providers. You could get more detailed information from their websites. |
| Mail Extender | If the mail server is defined with another name, please type the name in this area. Such mail server will be used as backup mail exchange. |
| Determine Real WAN IP | <p>If a Vigor router is installed behind any NAT router, you can enable such function to locate the real WAN IP.</p> <p>When the WAN IP used by Vigor router is private IP, this function can detect the public IP used by the NAT router and use the detected IP address for DDNS update.</p> <p>There are two methods offered for you to choose:</p>  <p>WAN IP - If it is selected and the WAN IP of Vigor router is private, DDNS update will take place right away.</p> <p>Internet IP – If it is selected and the WAN IP of Vigor router is private, it will be converted to public IP before DDNS update takes place.</p> |

- Click **OK** button to activate the settings. You will see your setting has been saved.

Disable the Function and Clear all Dynamic DNS Accounts

In the DDNS setup menu, uncheck **Enable Dynamic DNS Setup**, and push **Clear All** button to disable the function and clear all accounts from the router.

Delete a Dynamic DNS Account

In the DDNS setup menu, click the **Index** number you want to delete and then push **Clear All** button to delete the account.

3.8.2 LAN DNS

LAN DNS is a simple version of DNS server. It is not necessary for the user to build another DNS server in LAN. With such feature, the user can configure some services (such as ftp, www or database) with domain name which is easy to be accessed.

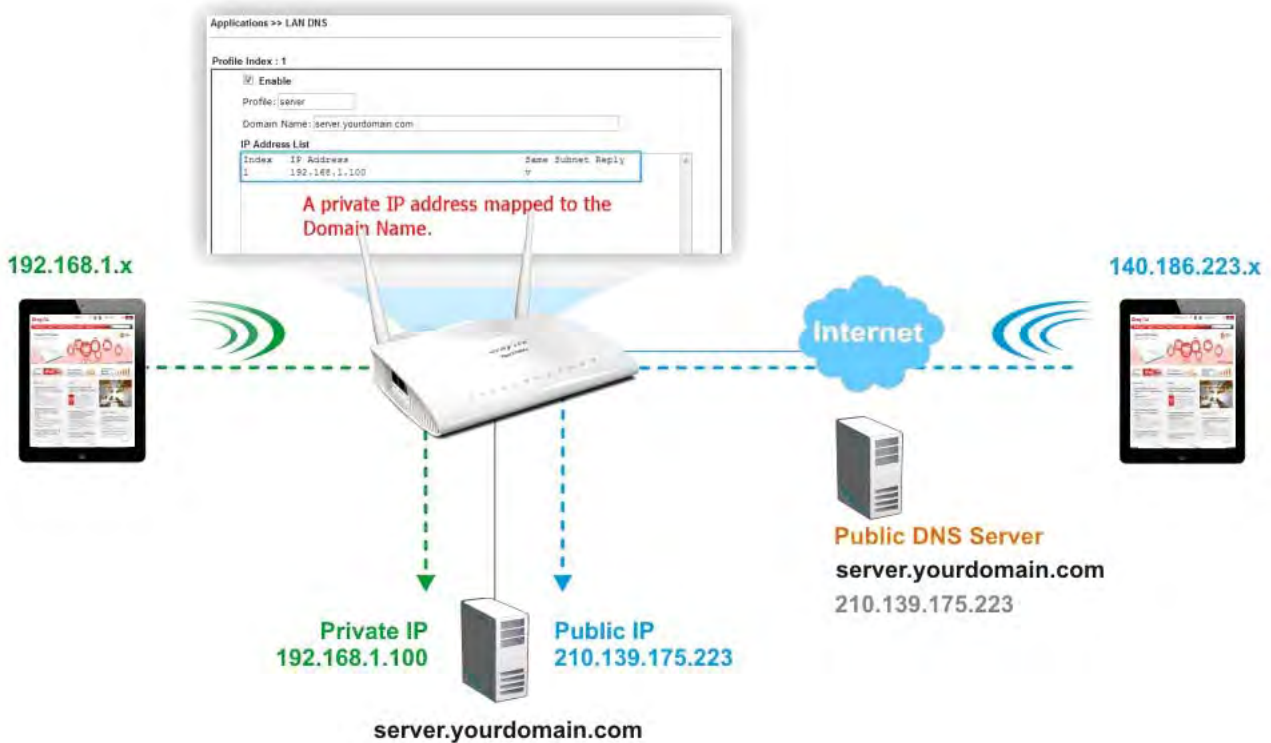

Simply click **Application>>LAN DNS** to open the following page.

Applications >> LAN DNS

| LAN DNS Resolution | | | | Set to Factory Default |
|--------------------------|-------|---------|-------------|------------------------|
| Enable | Index | Profile | Domain Name | |
| <input type="checkbox"/> | 1. | | | |
| <input type="checkbox"/> | 2. | | | |
| <input type="checkbox"/> | 3. | | | |
| <input type="checkbox"/> | 4. | | | |
| <input type="checkbox"/> | 5. | | | |
| <input type="checkbox"/> | 6. | | | |
| <input type="checkbox"/> | 7. | | | |
| <input type="checkbox"/> | 8. | | | |
| <input type="checkbox"/> | 9. | | | |
| <input type="checkbox"/> | 10. | | | |

<< 1-10 | 11-20 >>

OK

Each item is explained as follows:

| Item | Description |
|------------------------|-----------------------------------------------------|
| Set to Factory Default | Clear all profiles and recover to factory settings. |
| Enable | Check the box to enable the selected profile. |

| | |
|--------------------|---------------------------------------------------------------|
| Index | Click the number below Index to access into the setting page. |
| Profile | Display the name of the LAN DNS profile. |
| Domain Name | Display the domain name of the LAN DNS profile. |

You can set up to 20 LAN DNS profiles.

To create a LAN DNS profile:

1. Click any index, say Index No. 1.
2. The detailed settings with index 1 are shown below.

Applications >> LAN DNS

Profile Index : 1

Enable

Profile:

Domain Name:

IP Address List

| Index | IP Address | Same Subnet Reply |
|-------|------------|-------------------|
| 1 | 172.16.3.8 | |

Available settings are explained as follows:

| Item | Description |
|------------------------|------------------------------------------------------------------------------------------------------------------------------------------------------------------------------------------------------------------------------------------------------------------------------------------------------------------------|
| Enable | Check this box to enable such profile. |
| Profile | Type a name for such profile. |
| Domain Name | Type the domain name for such profile. |
| IP Address List | <p>The IP address listed here will be used for mapping with the domain name specified above. In general, one domain name maps with one IP address. If required, you can configure two IP addresses mapping with the same domain name.</p> <p>Add – Click it to open a dialog to type the host's IP address.</p> |

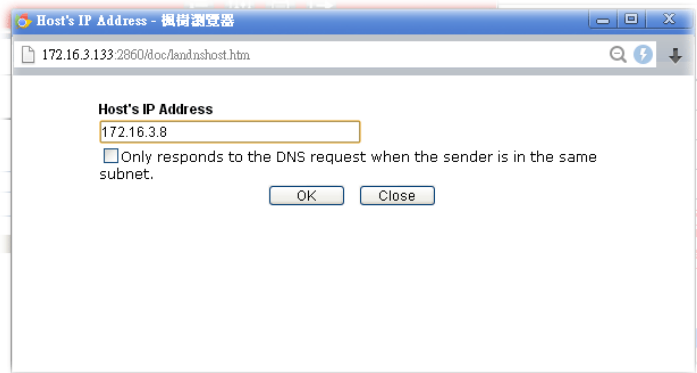

- **Only responds to the DNS....** – Different LAN PCs can share the same domain name. However, you have to check this box to make the router identify & respond the IP address for the DNS query coming from different LAN PC.

Delete – Click it to remove an existed IP address on the list.

3. Click **OK** button to save the settings.
4. A new LAN DNS profile has been created.

Applications >> LAN DNS

LAN DNS Resolution | [Set to Factory Default](#) |

| Enable | Index | Profile | Domain Name |
|-------------------------------------|-------|---------|----------------|
| <input checked="" type="checkbox"/> | 1. | MAIL | ms.draytek.com |
| <input type="checkbox"/> | 2. | | |
| <input type="checkbox"/> | 3. | | |
| <input type="checkbox"/> | 4. | | |
| <input type="checkbox"/> | 5. | | |
| <input type="checkbox"/> | 6. | | |
| <input type="checkbox"/> | 7. | | |
| <input type="checkbox"/> | 8. | | |
| <input type="checkbox"/> | 9. | | |
| <input type="checkbox"/> | 10. | | |

<< 1-10 | 11-20 >>

OK

3.8.3 Schedule

The Vigor router has a built-in clock which can update itself manually or automatically by means of Network Time Protocols (NTP). As a result, you can not only schedule the router to dialup to the Internet at a specified time, but also restrict Internet access to certain hours so that users can connect to the Internet only during certain hours, say, business hours. The schedule is also applicable to other functions.

You have to set your time before set schedule. In **System Maintenance>> Time and Date** menu, press **Inquire Time** button to set the Vigor router's clock to current time of your PC. The clock will reset once if you power down or reset the router. There is another way to set up time. You can inquiry an NTP server (a time server) on the Internet to synchronize the router's clock. This method can only be applied when the WAN connection has been built up.

Applications >> Schedule

Schedule: | [Set to Factory Default](#) |

| Index | Status | Index | Status |
|--------------------|--------|---------------------|--------|
| 1. | x | 9. | x |
| 2. | x | 10. | x |
| 3. | x | 11. | x |
| 4. | x | 12. | x |
| 5. | x | 13. | x |
| 6. | x | 14. | x |
| 7. | x | 15. | x |
| 8. | x | | |

Status: v --- Active, x --- Inactive

Available settings are explained as follows:

| Item | Description |
|-------------------------------|---------------------------------------------------------------------------|
| Set to Factory Default | Clear all profiles and recover to factory settings. |
| Index | Click the number below Index to access into the setting page of schedule. |
| Status | Display if this schedule setting is active or inactive. |

You can set up to 15 schedules. Then you can apply them to your **Internet Access** or **VPN and Remote Access >> LAN-to-LAN** settings.

To add a schedule:

1. Click any index, say Index No. 1.
2. The detailed settings of the call schedule with index 1 are shown below.

Index No. 1

Enable Schedule Setup

Start Date (yyyy-mm-dd) 2000 1 1

Start Time (hh:mm) 0 : 0

Duration Time (hh:mm) 0 : 0

Action Force On

Idle Timeout 0 minute(s).(max. 255, 0 for default)

How Often

Once

Weekdays

Sun Mon Tue Wed Thu Fri Sat

OK Clear Cancel

Available settings are explained as follows:

| Item | Description |
|--------------------------------|--------------------------------------------------------------------------------------------------------------------------------------------------------------------------------------------------------------------------------------------------------------------------------------------------------------------------------------------------------------------------------------------------------------------------------------------------------------------------------------------------------------------------------------------------------------------------------------------|
| Enable Schedule Setup | Check to enable the schedule. |
| Start Date (yyyy-mm-dd) | Specify the starting date of the schedule. |
| Start Time (hh:mm) | Specify the starting time of the schedule. |
| Duration Time (hh:mm) | Specify the duration (or period) for the schedule. |
| Action | Specify which action Call Schedule should apply during the period of the schedule. Force On -Force the connection to be always on. Force Down -Force the connection to be always down. Enable Dial-On-Demand -Specify the connection to be dial-on-demand and the value of idle timeout should be specified in Idle Timeout field. Disable Dial-On-Demand -Specify the connection to be up when it has traffic on the line. Once there is no traffic over idle timeout, the connection will be down and never up again during the schedule. |
| Idle Timeout | Specify the duration (or period) for the schedule. How often -Specify how often the schedule will be applied Once -The schedule will be applied just once Weekdays -Specify which days in one week should perform the schedule. |

- Click **OK** button to save the settings.

Example

Suppose you want to control the PPPoE Internet access connection to be always on (Force On) from 9:00 to 18:00 for whole week. Other time the Internet access connection should be disconnected (Force Down).

Office

Hour:

(Force On)



Mon - Sun 9:00 am to 6:00 pm

1. Make sure the PPPoE connection and **Time Setup** is working properly.
2. Configure the PPPoE always on from 9:00 to 18:00 for whole week.
3. Configure the **Force Down** from 18:00 to next day 9:00 for whole week.
4. Assign these two profiles to the PPPoE Internet access profile. Now, the PPPoE Internet connection will follow the schedule order to perform **Force On** or **Force Down** action according to the time plan that has been pre-defined in the schedule profiles.

3.8.4 UPnP

The **UPnP** (Universal Plug and Play) protocol is supported to bring to network connected devices the ease of installation and configuration which is already available for directly connected PC peripherals with the existing Windows 'Plug and Play' system. For NAT routers, the major feature of UPnP on the router is "NAT Traversal". This enables applications inside the firewall to automatically open the ports that they need to pass through a router. It is more reliable than requiring a router to work out by itself which ports need to be opened. Further, the user does not have to manually set up port mappings or a DMZ. **UPnP is available on Windows XP** and the router provide the associated support for MSN Messenger to allow full use of the voice, video and messaging features.

Applications >> UPnP

UPnP

| |
|------------------------------------------------------------------------------------------------------------------------------------------------------------------------------------|
| <input checked="" type="checkbox"/> Enable UPnP Service <input type="checkbox"/> Enable Connection Control Service <input type="checkbox"/> Enable Connection Status Service |
|------------------------------------------------------------------------------------------------------------------------------------------------------------------------------------|

Note: To allow NAT pass-through to a UPnP-enabled client on the LAN, enable UPnP service above and ensure that the used connection service is also ticked.

Available settings are explained as follows:

| Item | Description |
|---------------------|----------------------------------------------------------------------------------------------------------------|
| Enable UPnP Service | Accordingly, you can enable either the Connection Control Service or Connection Status Service . |

After setting **Enable UPnP Service** setting, an icon of **IP Broadband Connection on Router** on Windows XP/Network Connections will appear. The connection status and control status will be able to be activated. The NAT Traversal of UPnP enables the multimedia features of your applications to operate. This has to manually set up port mappings or use other similar methods. The screenshots below show examples of this facility.

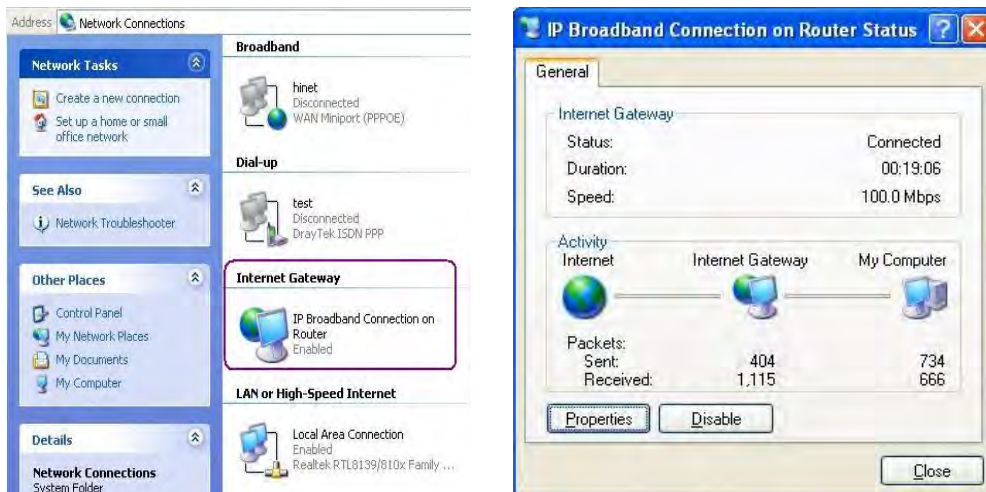

The UPnP facility on the router enables UPnP aware applications such as MSN Messenger to discover what are behind a NAT router. The application will also learn the external IP address and configure port mappings on the router. Subsequently, such a facility forwards packets from the external ports of the router to the internal ports used by the application.

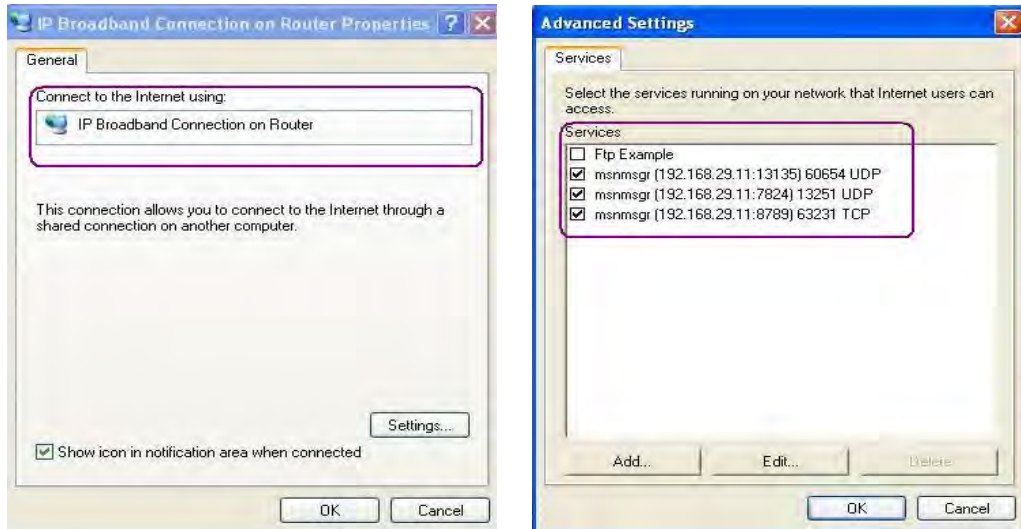

The reminder as regards concern about Firewall and UPnP

Can't work with Firewall Software

Enabling firewall applications on your PC may cause the UPnP function not working properly. This is because these applications will block the accessing ability of some network ports.

Security Considerations

Activating the UPnP function on your network may incur some security threats. You should consider carefully these risks before activating the UPnP function.

- Some Microsoft operating systems have found out the UPnP weaknesses and hence you need to ensure that you have applied the latest service packs and patches.
- Non-privileged users can control some router functions, including removing and adding port mappings.

The UPnP function dynamically adds port mappings on behalf of some UPnP-aware applications. When the applications terminate abnormally, these mappings may not be removed.

3.8.5 IGMP

IGMP is the abbreviation of *Internet Group Management Protocol*. It is a communication protocol which is mainly used for managing the membership of Internet Protocol multicast groups.

Applications >> IGMP

IGMP

Enable IGMP Proxy WAN1 ▾
 IGMP Proxy is to act as a multicast proxy for hosts on the LAN side. Enable IGMP Proxy, if you will access any multicast group. But this function **take no effect when Bridge Mode is enabled**.

Enable IGMP Snooping
 Enable IGMP Snooping, multicast traffic is only forwarded to ports that have members of that group. Disable IGMP snooping, multicast traffic is treated in the same manner as broadcast traffic.

[Refresh](#)

| Working Multicast Groups | | | | | |
|--------------------------|----------|----|----|----|----|
| Index | Group ID | P1 | P2 | P3 | P4 |
| | | | | | |

Available settings are explained as follows:

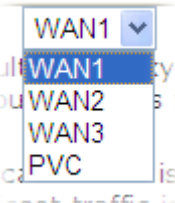
| Item | Description |
|-----------------------------|---------------------------------------------------------------------------------------------------------------------------------------------------------------------------------------------------------------------------------------------------------|
| Enable IGMP Proxy | Check this box to enable this function. The application of multicast will be executed through WAN port. In addition, such function is available in NAT mode.  |
| Enable IGMP Snooping | Check this box to enable this function. Multicast traffic will be forwarded to ports that have members of that group. Disabling IGMP snooping will make multicast traffic treated in the same manner as broadcast traffic. |
| Refresh | Click this link to renew the working multicast group status. |
| Group ID | This field displays the ID port for the multicast group. The available range for IGMP starts from 224.0.0.0 to 239.255.255.254. |
| P1 to P4 | It indicates the LAN port used for the multicast group. |

After finishing all the settings here, please click **OK** to save the configuration.

3.8.6 Wake on LAN

A PC client on LAN can be woken up by the router it connects. When a user wants to wake up a specified PC through the router, he/she must type correct MAC address of the specified PC on this web page of **Wake on LAN (WOL)** of this router.

In addition, such PC must have installed a network card supporting WOL function. By the way, WOL function must be set as “Enable” on the BIOS setting.

Application >> Wake on LAN

Wake on LAN

Note: Wake on LAN integrates with **Bind IP to MAC** function, only binded PCs can wake up through IP.

Wake by:

IP Address:

MAC Address:

Result

Available settings are explained as follows:

| Item | Description |
|--------------------|---------------------------------------------------------------------------------------------------------------------------------------------------------------------------------------------------------------------------------------------------------------------------------------------------------------------------------------------------------------------------------------------------------------------------------------------------------------------------------------------------------------------------------------|
| Wake by | Two types provide for you to wake up the bound IP. If you choose Wake by MAC Address, you have to type the correct MAC address of the host in MAC Address boxes. If you choose Wake by IP Address, you have to choose the correct IP address. <div style="text-align: right;"> Wake by: <input type="text" value="MAC Address"/> <div style="border: 1px solid #ccc; padding: 2px; display: inline-block;"> MAC Address MAC Address IP Address </div> </div> |
| IP Address | The IP addresses that have been configured in Firewall>>Bind IP to MAC will be shown in this drop down list. Choose the IP address from the drop down list that you want to wake up. |
| MAC Address | Type any one of the MAC address of the bound PCs. |
| Wake Up | Click this button to wake up the selected IP. See the following figure. The result will be shown on the box. |

Wake on LAN

Note: Wake on LAN integrates with [Bind IP to MAC](#) function, only binded PCs can wake up through IP.

Wake by: MAC Address

IP Address: ---

MAC Address: : : : : :

Result

Send command to client done.

3.8.7 SMS / Mail Alert Service

The function of SMS (Short Message Service)/Mail Alert is that Vigor router sends a message to user's mobile or e-mail box through specified service provider to assist the user knowing the real-time abnormal situations.

Vigor router allows you to set up to **10** SMS profiles which will be sent out according to different conditions.

SMS Provider

This page allows you to specify SMS provider, who will get the SMS, what the content is and when the SMS will be sent.

| | SMS Provider | Mail Server | Set to Factory Default |
|---------------------------------------|------------------------------------------------|----------------------|----------------------------------------------------|
| Index | SMS Provider | Recipient | Notify Profile |
| 1 <input checked="" type="checkbox"/> | 1 - Line_down <input type="button" value="v"/> | <input type="text"/> | 1 - Notify_attack <input type="button" value="v"/> |
| 2 <input type="checkbox"/> | 1 - Line_down <input type="button" value="v"/> | <input type="text"/> | 1 - Notify_attack <input type="button" value="v"/> |
| 3 <input type="checkbox"/> | 1 - Line_down <input type="button" value="v"/> | <input type="text"/> | 1 - Notify_attack <input type="button" value="v"/> |
| 4 <input type="checkbox"/> | 1 - Line_down <input type="button" value="v"/> | <input type="text"/> | 1 - Notify_attack <input type="button" value="v"/> |
| 5 <input type="checkbox"/> | 1 - Line_down <input type="button" value="v"/> | <input type="text"/> | 1 - Notify_attack <input type="button" value="v"/> |
| 6 <input type="checkbox"/> | 1 - Line_down <input type="button" value="v"/> | <input type="text"/> | 1 - Notify_attack <input type="button" value="v"/> |
| 7 <input type="checkbox"/> | 1 - Line_down <input type="button" value="v"/> | <input type="text"/> | 1 - Notify_attack <input type="button" value="v"/> |
| 8 <input type="checkbox"/> | 1 - Line_down <input type="button" value="v"/> | <input type="text"/> | 1 - Notify_attack <input type="button" value="v"/> |
| 9 <input type="checkbox"/> | 1 - Line_down <input type="button" value="v"/> | <input type="text"/> | 1 - Notify_attack <input type="button" value="v"/> |
| 10 <input type="checkbox"/> | 1 - Line_down <input type="button" value="v"/> | <input type="text"/> | 1 - Notify_attack <input type="button" value="v"/> |

Available settings are explained as follows:

| Item | Description |
|---------------------|-------------------------------------------------------------------------------------------------------------------------|
| Index | Check the box to enable such profile. |
| SMS Provider | Use the drop down list to choose SMS service provider. You can click SMS Provider link to define the SMS server. |

| | |
|------------------|---------------------------------------------------------------------------------------------------------------------------------------------------------------------------------------------------------|
| Recipient | Type the name of the one who will receive the SMS. |
| Notify | Use the drop down list to choose a message profile. The recipient will get the content stated in the message profile. You can click the Notify Profile link to define the content of the SMS. |
| Schedule | Type the schedule number that the SMS will be sent out. You can click the Schedule(1-15) link to define the schedule. |

After finishing all the settings here, please click **OK** to save the configuration.

Mail Server

This page allows you to specify Mail Server profile, who will get the notification e-mail, what the content is and when the message will be sent.

Application >> SMS / Mail Alert Service

| SMS Provider | | Mail Server | | | Set to Factory Default | |
|---------------------------------------|-----------------|----------------------|-------------------|----------------------|------------------------|--|
| Index | Mail Service | Recipient | Notify Profile | Schedule(1-15) | | |
| 1 <input checked="" type="checkbox"/> | 1 - Mail_Notify | <input type="text"/> | 1 - Notify_attack | <input type="text"/> | <input type="text"/> | |
| 2 <input type="checkbox"/> | 1 - Mail_Notify | <input type="text"/> | 1 - Notify_attack | <input type="text"/> | <input type="text"/> | |
| 3 <input type="checkbox"/> | 1 - Mail_Notify | <input type="text"/> | 1 - Notify_attack | <input type="text"/> | <input type="text"/> | |
| 4 <input type="checkbox"/> | 1 - Mail_Notify | <input type="text"/> | 1 - Notify_attack | <input type="text"/> | <input type="text"/> | |
| 5 <input type="checkbox"/> | 1 - Mail_Notify | <input type="text"/> | 1 - Notify_attack | <input type="text"/> | <input type="text"/> | |
| 6 <input type="checkbox"/> | 1 - Mail_Notify | <input type="text"/> | 1 - Notify_attack | <input type="text"/> | <input type="text"/> | |
| 7 <input type="checkbox"/> | 1 - Mail_Notify | <input type="text"/> | 1 - Notify_attack | <input type="text"/> | <input type="text"/> | |
| 8 <input type="checkbox"/> | 1 - Mail_Notify | <input type="text"/> | 1 - Notify_attack | <input type="text"/> | <input type="text"/> | |
| 9 <input type="checkbox"/> | 1 - Mail_Notify | <input type="text"/> | 1 - Notify_attack | <input type="text"/> | <input type="text"/> | |
| 10 <input type="checkbox"/> | 1 - Mail_Notify | <input type="text"/> | 1 - Notify_attack | <input type="text"/> | <input type="text"/> | |

Available settings are explained as follows:

| Item | Description |
|---------------------|------------------------------------------------------------------------------------------------------------------------------------------------------------------------------------------------------------------|
| Index | Check the box to enable such profile. |
| Mail Service | Use the drop down list to choose mail service provider. You can click Mail Service link to define the mail server. |
| Recipient | Type the e-mail address of the one who will receive the notification message. |
| Notify | Use the drop down list to choose a message profile. The recipient will get the content stated in the message profile. You can click the Notify Profile link to define the content of the mail message. |

| | |
|-----------------|------------------------------------------------------------------------------------------------------------------------------------------|
| Schedule | Type the schedule number that the notification will be sent out. You can click the Schedule(1-15) link to define the schedule. |
|-----------------|------------------------------------------------------------------------------------------------------------------------------------------|

After finishing all the settings here, please click **OK** to save the configuration.

3.8.8 Bonjour

Bonjour is a service discovery protocol which is a built-in service in Mac OS X; for Windows or Linux platform, there are correspondent software to enable this function for free.

Usually, users have to configure the router or personal computers to use above services. Sometimes, the configuration (e.g., IP settings, port number) is complicated and not easy to complete. The purpose of Bonjour is to decrease the settings configuration (e.g., IP setting). If the host and user's computer have the plug-in Bonjour driver install, they can utilize the service offered by the router by clicking the router name icon. In short, what the Clients/users need to know is the name of the router only.

To enable the Bonjour service, click **Application>>Bonjour** to open the following page. Check the box(es) of the server service(s) that you want to share to the LAN clients.

Applications >> Bonjour

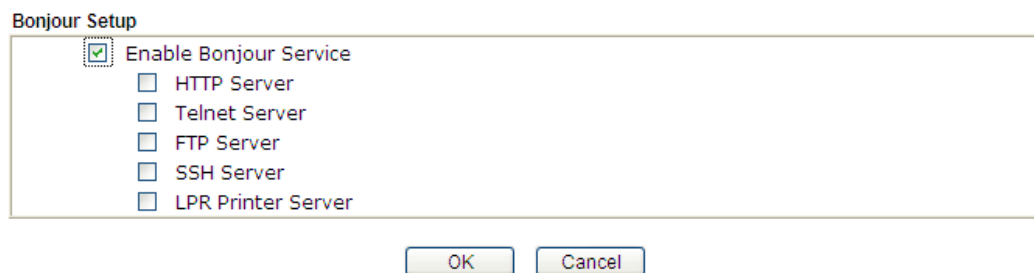

Below shows an example for applying the Bonjour feature that Vigor router can be used as the FTP server.

1. Here, we use Firefox and DNSSD to discover the service in such case. Therefore, just ensure the Bonjour client program and DNSSD for Firefox have been installed on the computer.

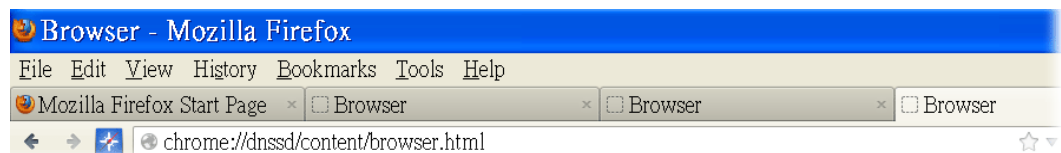

- Open the web browser, Firefox. If Bonjour and DNSSD have been installed, you can open the web page (DNSSD) and see the following results.

| Interface | Name | Type | Domain | Service Info |
|-----------|---------------------------------------------|--------------------|--------|-------------------------------------------------------|
| 2 | DS1010Plus | _http._tcp. | local. | Select a service on the left to view further details. |
| 2 | DS1010Plus(WebDAV) | _http._tcp. | local. | |
| 2 | HP LaserJet 1300 | _ipp._tcp. | local. | |
| 2 | tctseng-virtual-machine | _udisks-ssh._tcp. | local. | |
| 2 | tctseng-virtual-machine [00:0c:29:78:bc:24] | _workstation._tcp. | local. | |
| 2 | tomkao-desktop [00:0c:29:26:09:5d] | _workstation._tcp. | local. | |

- Open **System Maintenance >> Management**. Type a name (e.g., Dray_2925) as the Router Name and click **OK**.

System Maintenance >> Management

OK

- Next, open **Applications >> Bonjour**. Check the service that you want to use via Bonjour.

Applications >> Bonjour

OK

Cancel

- Open the DNSSD page again. The available items will be changed as the follows. It means the Vigor router (based on Bonjour protocol) is ready to be used as a printer server, FTP server, SSH Server, Telnet Server, and HTTP Server.

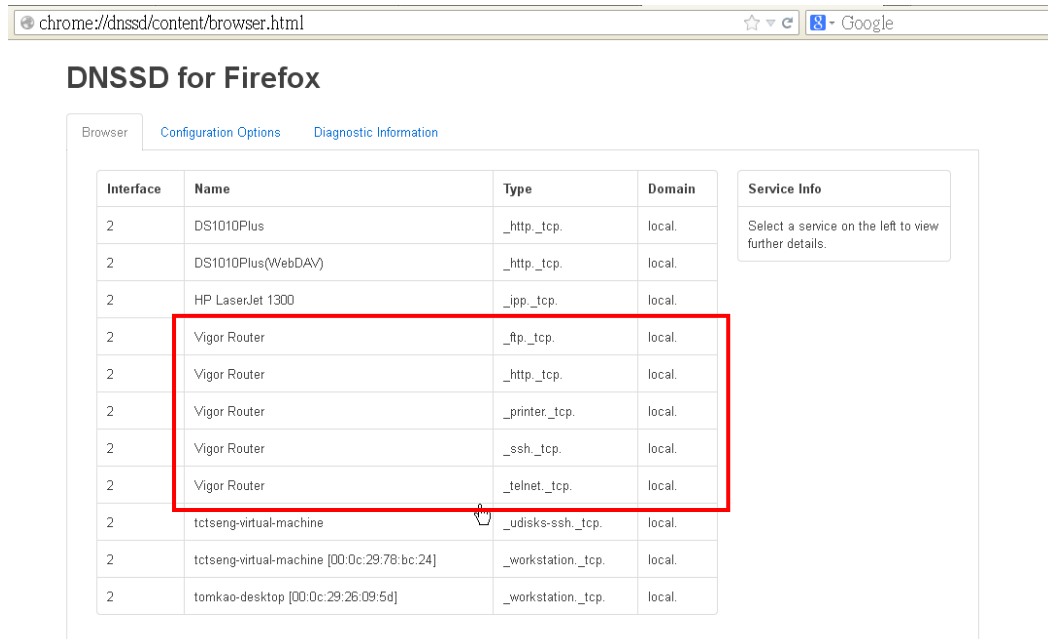

- Now, any page or document can be printed out through Vigor router (installed with a printer).

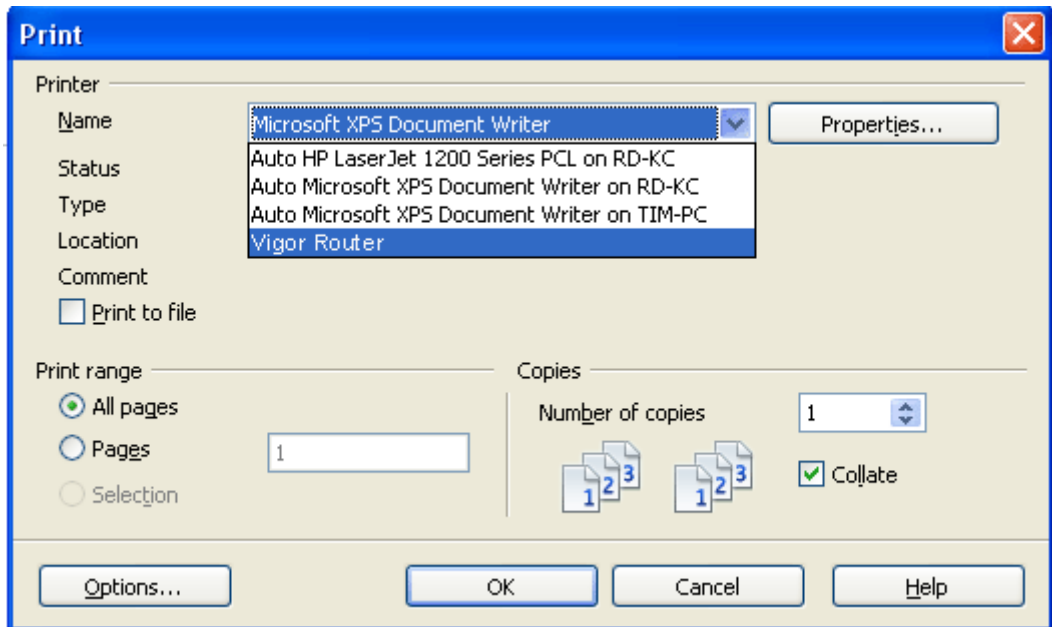

3.9 VPN and Remote Access

A Virtual Private Network (VPN) is the extension of a private network that encompasses links across shared or public networks like the Internet. In short, by VPN technology, you can send data between two computers across a shared or public network in a manner that emulates the properties of a point-to-point private link. The Vigor 2760 allows dial-out to any compatible VPN server/network using L2TP, IPsec or PPTP.

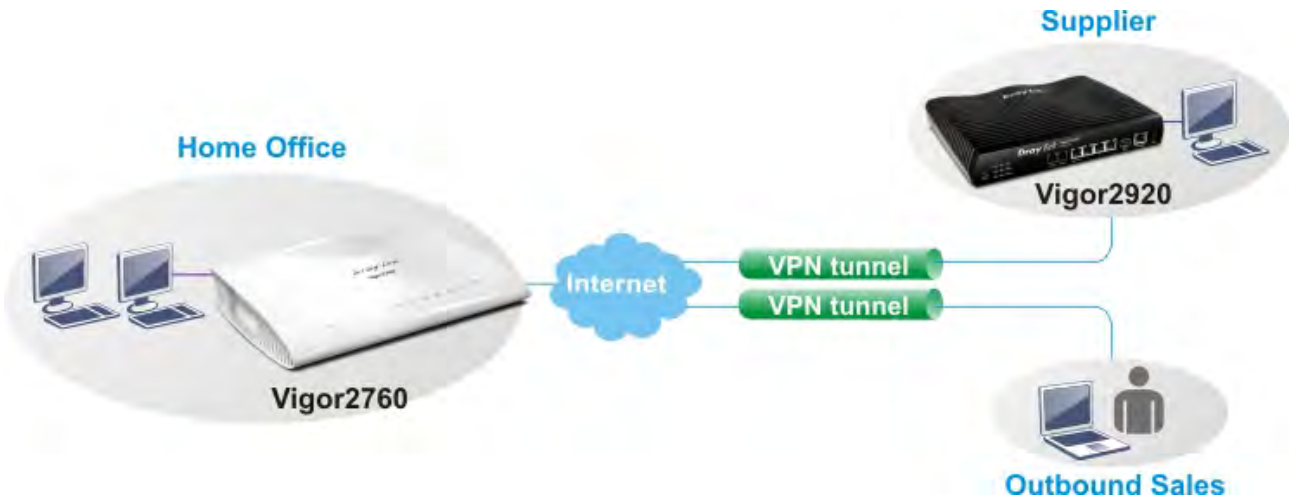

3.9.1 LAN to LAN

Here you can manage LAN-to-LAN connections by maintaining a table of connection profiles. You may set parameters including connection peer ID, connection type (VPN connection - including PPTP, IPsec Tunnel, and L2TP by itself or over IPsec) and corresponding security methods, etc.

The router supports up to 2 outgoing VPN tunnels simultaneously. The following figure shows the summary table.

VPN and Remote Access >> LAN to LAN ?

LAN-to-LAN Profiles: | [Set to Factory Default](#) |

| Index | Name | Active | Status | Index | Name | Active | Status |
|-----------|------|--------------------------|--------|-----------|------|--------------------------|--------|
| <u>1.</u> | ??? | <input type="checkbox"/> | --- | <u>5.</u> | ??? | <input type="checkbox"/> | --- |
| <u>2.</u> | ??? | <input type="checkbox"/> | --- | <u>6.</u> | ??? | <input type="checkbox"/> | --- |
| <u>3.</u> | ??? | <input type="checkbox"/> | --- | <u>7.</u> | ??? | <input type="checkbox"/> | --- |
| <u>4.</u> | ??? | <input type="checkbox"/> | --- | <u>8.</u> | ??? | <input type="checkbox"/> | --- |

Available settings are explained as follows:

| Item | Description |
|-------------------------------|---------------------------------------------------------------------------------------------------|
| Set to Factory Default | Click to clear all indexes. |
| Name | Indicate the name of the LAN-to-LAN profile. The symbol ??? represents that the profile is empty. |
| Active | V – means the profile has been enabled. X – mans the profile has not been enabled. |

| | |
|---------------|-------------------------------------------------------------------------------------------------------------------------------|
| Status | Indicate the status of individual profiles. The symbol V and X represent the profile to be active and inactive, respectively. |
|---------------|-------------------------------------------------------------------------------------------------------------------------------|

To edit each profile:

1. Click each index to edit each profile and you will get the following page. Each LAN-to-LAN profile includes 4 subgroups. If the fields gray out, it means you may leave it untouched. The following explanations will guide you to fill all the necessary fields.

For the web page is too long, we divide the page into several sections for explanation.

VPN and Remote Access >> LAN to LAN

Profile Index : 1

1. Common Settings

| | |
|---------------------------------------------------------------------------------------------------------------------------------------------------------------------------------------------------------------------------------------------|--------------------------------------------------------------------------------------------------------------------------------------------------------------------------------------------|
| Profile Name <input type="text" value="???"/> <input type="checkbox"/> Enable this profile | <input type="checkbox"/> Always on Idle Timeout <input type="text" value="300"/> second(s) <input type="checkbox"/> Enable PING to keep alive PING to the IP <input type="text"/> |
| Netbios Naming Packet <input checked="" type="radio"/> Pass <input type="radio"/> Block Multicast via VPN <input type="radio"/> Pass <input checked="" type="radio"/> Block <small>(for some IGMP,IP-Camera,DHCP Relay..etc.)</small> | |

2. Dial-Out Settings

| | |
|-----------------------------------------------------------------------------------------------------------------------------------------------------------------------------------------------------|----------------------------------------------------------------------------------------------------------------------------------------------------------------------------------------------------------------------------------------------------------------------------------------------------------------------------------------------------------|
| Type of Server I am calling <input checked="" type="radio"/> PPTP <input type="radio"/> IPsec Tunnel <input type="radio"/> L2TP with IPsec Policy <input type="text" value="None"/> | Username <input type="text" value="???"/> Password(Max 15 char) <input type="text"/> PPP Authentication <input type="text" value="PAP/CHAP/MS-CHAP/MS-CHAPv2"/> VJ Compression <input checked="" type="radio"/> On <input type="radio"/> Off |
| Server IP/Host Name for VPN. (such as draytek.com or 123.45.67.89) <input type="text"/> | IKE Authentication Method <input checked="" type="radio"/> Pre-Shared Key IKE Pre-Shared Key <input type="text"/> <input type="radio"/> Digital Signature(X.509) Peer ID <input type="text" value="None"/> Local ID <input checked="" type="radio"/> Alternative Subject Name First <input type="radio"/> Subject Name First |
| | IPsec Security Method <input checked="" type="radio"/> Medium(AH) <input type="radio"/> High(ESP) <input type="text" value="DES without Authentication"/> <input type="button" value="Advanced"/> |
| | Index(1-15) in Schedule Setup: <input type="text"/> , <input type="text"/> , <input type="text"/> , <input type="text"/> |

3. TCP/IP Network Settings

| | |
|-----------------------------------------------------------------------------------------------------------------------------------------------------------------------------------------------------------------------------------------------------------------------------------------------------------------------------------------------------------------------------------------------------------|-------------------------------------------------------------------------------------------------------------------------------------------------------------------------------------------------------------------------------------------------------|
| My WAN IP <input type="text" value="0.0.0.0"/> Remote Gateway IP <input type="text" value="0.0.0.0"/> Remote Network IP <input type="text" value="0.0.0.0"/> Remote Network Mask <input type="text" value="255.255.255.0"/> Local Network IP <input type="text" value="192.168.1.1"/> Local Network Mask <input type="text" value="255.255.255.0"/> <input type="button" value="More"/> | RIP Direction <input type="text" value="Disable"/> From first subnet to remote network, you have to do <input type="text" value="Route"/> <input type="checkbox"/> Change default route to this VPN tunnel (Only single WAN supports this) |
|-----------------------------------------------------------------------------------------------------------------------------------------------------------------------------------------------------------------------------------------------------------------------------------------------------------------------------------------------------------------------------------------------------------|-------------------------------------------------------------------------------------------------------------------------------------------------------------------------------------------------------------------------------------------------------|

Available settings are explained as follows:

| Item | Description |
|---------------------------------|----------------------------------------------------------------------------------------------------------------------------------------------------------------------------------------------------------------------------------------------------------------------------------------------------------------------------------------------------------------------------------------------------------------------------------------------------------------------------------------------------------------------------------------------------------------------------------------------------------------------------------------------------------------------------------------------------------------------------------------------------------------------------------------------------------------------------------------------------------------------------------------------------------------------------------------------------------------------------------------------------------------------------------------------------------------------------------------------------------------------------------------------------------------------------------------------------------------------------------------------------------------------------------------------------------------------------------------------------------------------------------------------------------------------------------------------------------------------------------------------------------------------------------------------------------------------------------------------------------------------------------------------------------------------------------------------------------------------------------------------------------------------------------------------------------------------------------------------------------------------------------------------------------------------------------------------------------------------------------------------------------------------------------------------------------------------------------------------------------------------------------------------------------------------------------------------------------------------------------------------------------------------------------------------------------------------------------------------------------------|
| <p>Common Settings</p> | <p>Profile Name – Specify a name for the profile of the LAN-to-LAN connection.</p> <p>Enable this profile - Check here to activate this profile.</p> <p>Netbios Naming Packet</p> <ul style="list-style-type: none"> ● Pass – click it to have an inquiry for data transmission between the hosts located on both sides of VPN Tunnel while connecting. ● Block – When there is conflict occurred between the hosts on both sides of VPN Tunnel in connecting, such function can block data transmission of Netbios Naming Packet inside the tunnel. <p>Multicast via VPN - Some programs might send multicast packets via VPN connection.</p> <ul style="list-style-type: none"> ● Pass – Click this button to let multicast packets pass through the router. ● Block – This is default setting. Click this button to let multicast packets be blocked by the router. <p>Always On-Check to enable router always keep VPN connection.</p> <p>Idle Timeout: The default value is 300 seconds. If the connection has been idled over the value, the router will drop the connection.</p> <p>Enable PING to keep alive - This function is to help the router to determine the status of IPsec VPN connection, especially useful in the case of abnormal VPN IPsec tunnel disruption. For details, please refer to the note below. Check to enable the transmission of PING packets to a specified IP address.</p> <p>Enable PING to keep alive is used to handle abnormal IPsec VPN connection disruption. It will help to provide the state of a VPN connection for router’s judgment of redial. Normally, if any one of VPN peers wants to disconnect the connection, it should follow a serial of packet exchange procedure to inform each other. However, if the remote peer disconnect without notice, Vigor router will by no where to know this situation. To resolve this dilemma, by continuously sending PING packets to the remote host, the Vigor router can know the true existence of this VPN connection and react accordingly. This is independent of DPD (dead peer detection).</p> <p>PING to the IP - Enter the IP address of the remote host that located at the other-end of the VPN tunnel.</p> |
| <p>Dial-Out Settings</p> | <p>Type of Server I am calling - PPTP - Build a PPTP VPN connection to the server through the Internet. You should set the identity like User Name and Password below for the authentication of remote server.</p> <p>IPsec Tunnel - Build an IPsec VPN connection to the</p> |

server through Internet.

L2TP with IPsec Policy - Build a L2TP VPN connection through the Internet. You can select to use L2TP alone or with IPsec. Select from below:

- **None:** Do not apply the IPsec policy. Accordingly, the VPN connection employed the L2TP without IPsec policy can be viewed as one pure L2TP connection.
- **Nice to Have:** Apply the IPsec policy first, if it is applicable during negotiation. Otherwise, the dial-out VPN connection becomes one pure L2TP connection.

Must: Specify the IPsec policy to be definitely applied on the L2TP connection.

User Name - This field is applicable when you select, PPTP or L2TP with or without IPsec policy above. The length of the name is limited to 49 characters.

Password - This field is applicable when you select PPTP or L2TP with or without IPsec policy above. The length of the password is limited to 15 characters.

PPP Authentication - This field is applicable when you select, PPTP or L2TP with or without IPsec policy above. PAP/CHAP is the most common selection due to wild compatibility.

VJ compression - This field is applicable when you select PPTP or L2TP with or without IPsec policy above. VJ Compression is used for TCP/IP protocol header compression. Normally set to **Yes** to improve bandwidth utilization.

IKE Authentication Method - This group of fields is applicable for IPsec Tunnels and L2TP with IPsec Policy.

- **Pre-Shared Key** - Input 1-63 characters as pre-shared key.
- **Digital Signature (X.509)** - Select one predefined Profiles set in the **VPN and Remote Access >>IPsec Peer Identity**.

Peer ID - Select one of the predefined Profiles set in **VPN and Remote Access >>IPsec Peer Identity**.

Local ID - This item is optional and can be used only in IKE aggressive mode.

- **Local Certificate** - Select one of the profiles set in **Certificate Management>>Local Certificate**.

IPsec Security Method - This group of fields is a must for IPsec Tunnels and L2TP with IPsec Policy.

- **Medium AH (Authentication Header)** means data will be authenticated, but not be encrypted. By default, this option is active.
 - **High (ESP-Encapsulating Security Payload)**- means payload (data) will be encrypted and authenticated. Select from below:
 - **DES without Authentication** -Use DES encryption algorithm and not apply any authentication scheme.
-

- **DES with Authentication**-Use DES encryption algorithm and apply MD5 or SHA-1 authentication algorithm.
- **3DES without Authentication**-Use triple DES encryption algorithm and not apply any authentication scheme.
- **3DES with Authentication**-Use triple DES encryption algorithm and apply MD5 or SHA-1 authentication algorithm.
- **AES without Authentication**-Use AES encryption algorithm and not apply any authentication scheme.
- **AES with Authentication**-Use AES encryption algorithm and apply MD5 or SHA-1 authentication algorithm.

Advanced - Specify mode, proposal and key life of each IKE phase, Gateway, etc.

The window of advance setup is shown as below:

IKE phase 1 mode -Select from **Main** mode and **Aggressive** mode. The ultimate outcome is to exchange security proposals to create a protected secure channel. **Main** mode is more secure than **Aggressive** mode since more exchanges are done in a secure channel to set up the IPsec session. However, the **Aggressive** mode is faster. The default value in Vigor router is Main mode.

- **IKE phase 1 proposal**-To propose the local available authentication schemes and encryption algorithms to the VPN peers, and get its feedback to find a match. Two combinations are available for Aggressive mode and nine for **Main** mode. We suggest you select the combination that covers the most schemes.
- **IKE phase 2 proposal**-To propose the local available algorithms to the VPN peers, and get its feedback to find a match. Three combinations are available for both modes. We suggest you select the combination that covers the most algorithms.
- **IKE phase 1 key lifetime**-For security reason, the lifetime of key should be defined. The default value is 28800 seconds. You may specify a value in between 900 and 86400 seconds.
- **IKE phase 2 key lifetime**-For security reason, the lifetime of key should be defined. The default value is 3600 seconds. You may specify a value in between 600 and 86400 seconds.
- **Perfect Forward Secret (PFS)**-The IKE Phase 1 key

| | |
|---------------------------------------|--------------------------------------------------------------------------------------------------------------------------------------------------------------------------------------------------------------------------------------------------------------------------------------------------------------------------------------------------------------------------------------------------------------------------------------------------------------------------------------------------------------------------------------------------------------------------------------------------------------------------------------------------------------------------------------------------------------------------------------------------------------------------------------------------------------------------------------------------------------------------------------------------------------------------------------------------------------------------------------------------------------------------------------------------------------------------------------------------------------------------------------------------------------------------------------------------------------------------------------------------------------------------------------------------------------------------------------------------------------------------------------------------------------------------------------------------------------------------------------------------------------------------------------------------------------------------|
| | <p>will be reused to avoid the computation complexity in phase 2. The default value is inactive this function.</p> <p>Local ID-In Aggressive mode, Local ID is on behalf of the IP address while identity authenticating with remote VPN server. The length of the ID is limited to 47 characters.</p> <p>Index(1-15) - Set the wireless LAN to work at certain time interval only. You may choose up to 4 schedules out of the 15 schedules pre-defined in Applications >> Schedule setup. The default setting of this field is blank and the function will always work.</p> |
| <p>TCP/IP Network Settings</p> | <p>My WAN IP –This field is only applicable when you select PPTP or L2TP with or without IPsec policy above. The default value is 0.0.0.0, which means the Vigor router will get a PPP IP address from the remote router during the IPCP negotiation phase. If the PPP IP address is fixed by remote side, specify the fixed IP address here. Do not change the default value if you do not select PPTP or L2TP.</p> <p>Remote Gateway IP - This field is only applicable when you select PPTP or L2TP with or without IPsec policy above. The default value is 0.0.0.0, which means the Vigor router will get a remote Gateway PPP IP address from the remote router during the IPCP negotiation phase. If the PPP IP address is fixed by remote side, specify the fixed IP address here. Do not change the default value if you do not select PPTP or L2TP.</p> <p>Remote Network IP/ Remote Network Mask - Add a static route to direct all traffic destined to this Remote Network IP Address/Remote Network Mask through the VPN connection. For IPsec, this is the destination clients IDs of phase 2 quick mode.</p> <p>Local Network IP / Local Network Mask - Display the local network IP and mask for TCP / IP configuration. You can modify the settings if required.</p> <p>More - Add a static route to direct all traffic destined to more Remote Network IP Addresses/ Remote Network Mask through the VPN connection. This is usually used when you find there are several subnets behind the remote VPN router.</p> |

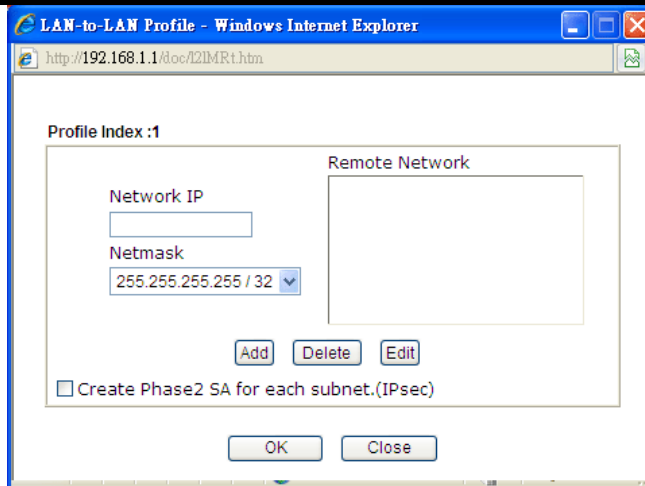

RIP Direction - The option specifies the direction of RIP (Routing Information Protocol) packets. You can enable/disable one of direction here. Herein, we provide four options: TX/RX Both, TX Only, RX Only, and Disable.

From first subnet to remote network, you have to do - If the remote network only allows you to dial in with single IP, please choose **NAT**, otherwise choose **Route**.

Change default route to this VPN tunnel - Check this box to change the default route with this VPN tunnel.

2. After finishing all the settings here, please click **OK** to save the configuration.

3.9.2 Connection Management

You can find the summary table of all outgoing VPN connections. You may disconnect any VPN connection by clicking **Drop** button. You may also intigate dial-out by using Dial-out Tool and clicking **Dial** button.

VPN and Remote Access >> Connection Management

Dial-out Tool Refresh Seconds : 10

VPN Connection Status

Current Page: 1 Page No.

| VPN | Type | Remote IP | Virtual Network | Tx Pkts | Tx Rate(Bps) | Rx Pkts | Rx Rate(Bps) | UpTime |
|-----|------|-----------|-----------------|---------|--------------|---------|--------------|--------|
|-----|------|-----------|-----------------|---------|--------------|---------|--------------|--------|

xxxxxxxx : Data is encrypted.
 xxxxxxxx : Data isn't encrypted.

Available settings are explained as follows:

| Item | Description |
|----------------------|--------------------------------------------------------------------------------------------------------------------------------------------------------------------------------------------------------------------------------------------------------------|
| Dial-out Tool | <p>Dial - Click this button to execute dial out function.</p> <p>Refresh Seconds - Choose the time for refresh the dial information among 5, 10, and 30.</p> <p>Refresh - Click this button to refresh the whole connection status.</p> |

3.10 Certificate Management

A digital certificate works as an electronic ID, which is issued by a certification authority (CA). It contains information such as your name, a serial number, expiration dates etc., and the digital signature of the certificate-issuing authority so that a recipient can verify that the certificate is real. Here Vigor router support digital certificates conforming to standard X.509.

Any entity wants to utilize digital certificates should first request a certificate issued by a CA server. It should also retrieve certificates of other trusted CA servers so it can authenticate the peer with certificates issued by those trusted CA servers. Certificates are valid for dial-out VPN connections.

Here you can manage generate and manage the local digital certificates, and set trusted CA certificates. Remember to adjust the time of Vigor router before using the certificate so that you can get the correct valid period of certificate.

Below shows the menu items for Certificate Management.



3.10.1 Local Certificate

Certificate Management >> Local Certificate

X509 Local Certificate Configuration

| Name | Subject | Status | Modify |
|-------|---------|--------|---------------------------------------------------------------------------|
| Local | --- | --- | <input type="button" value="View"/> <input type="button" value="Delete"/> |

X509 Local Certificate

Available settings are explained as follows:

| Item | Description |
|-----------------|-----------------------------------------------------------------------|
| Generate | Click this button to open Generate Certificate Request window. |

| Certificate Management >> Local Certificate | |
|-----------------------------------------------------------------------------------------------------------------------------------------------------------------------------------------------------------------------------------------------------------------------------------------------------------------------------------------------------------------------------------------------------------------------------------------------------------------------------------------------------------------------------------------------------------------------------------------------------------------------------------------------------------------------------------------------------------------------------------------------------------------------------------------------------------------------------------------------------------------------------------------------------------------------------------------------------------------------------------------------------------------|----------------------------------------------------------------------------|
| <p>Generate Certificate Signing Request</p> <p>Subject Alternative Name</p> <p>Type <input type="text" value="IP Address"/> <input type="button" value="v"/> IP <input type="text"/></p> <hr/> <p>Subject Name</p> <p>Country (C) <input type="text"/> State (ST) <input type="text"/> Location (L) <input type="text"/> Organization (O) <input type="text"/> Organization Unit (OU) <input type="text"/> Common Name (CN) <input type="text"/> Email (E) <input type="text"/></p> <hr/> <p>Key Type <input type="text" value="RSA"/> <input type="button" value="v"/> Key Size <input type="text" value="1024 Bit"/> <input type="button" value="v"/></p> <p style="text-align: center;"><input type="button" value="Generate"/></p> <p>Note: Please be noted that “Common Name” must be configured with rotuer’s WAN IP or domain name. Type in all the information that the window requests. Then click Generate again.</p> | |
| Import | Click this button to import a saved file as the certification information. |
| Refresh | Click this button to refresh the information listed below. |
| View | Click this button to view the detailed settings for certificate request. |
| Delete | Click this button to delete selected name with certification information. |

After clicking **GENERATE**, the generated information will be displayed on the window below:

Certificate Management >> Local Certificate

X509 Local Certificate Configuration

| Name | Subject | Status | Modify |
|-------|---------------------------------|------------|---------------------------------------------------------------------------|
| Local | /C=TW/ST=HC/L=HC/O=Draytek/O... | Requesting | <input type="button" value="View"/> <input type="button" value="Delete"/> |

X509 Local Certificate

```

-----BEGIN CERTIFICATE REQUEST-----
MIIBqjCCARMCQAQAwajELMAkGA1UEBhMCVFcxHzAUBgNVBAGTAkhDMQswCQYDVQQH
EwJlIQzEQMA4GA1UEChMHRHJheXRlay5jb20wgZ8wDQYJKoZIhvcNAQEBBQADgYOA
MIGJAoGBALMJdTsqfF97FEpYy+IqeJVJGuSRtqG6EtW8yTU5HQvXpAzczrgJBGr1k
TUBXa1X//EgnEccQA2LPSQIQ85Qychwq07Bm0EDf10wHwCa1A2QoGvIiODMC7f5w9x
A8m6+0f4xZ4QqnjXXgciCOBj1iAa6MLSce1synZhkgQ1QN5uFAgMBAAGGADANBgkq
hkiG9wOBAQUFAAOBgQCq3sdwVc21t9qn4U6X2BJsVzu7JHafSSeUnaYDZefCmGfX
9yojHpstNsmWsMRuAwGeKCWc8S/gLtHhr6iccMoToQFx/LWdaEPU5LqryBKKgC9t
eorpDa1/rC9ZwCra0t8XUmPqNoiytq8BxStTE8vULiIxmwaBvc1hWFSXKVLU7g==
-----END CERTIFICATE REQUEST-----

```

3.10.2 Trusted CA Certificate

Trusted CA certificate lists three sets of trusted CA certificate.

Certificate Management >> Trusted CA Certificate

X509 Trusted CA Certificate Configuration

| Name | Subject | Status | Modify | |
|--------------|---------|--------|-------------------------------------|---------------------------------------|
| Trusted CA-1 | --- | --- | <input type="button" value="View"/> | <input type="button" value="Delete"/> |
| Trusted CA-2 | --- | --- | <input type="button" value="View"/> | <input type="button" value="Delete"/> |
| Trusted CA-3 | --- | --- | <input type="button" value="View"/> | <input type="button" value="Delete"/> |

To import a pre-saved trusted CA certificate, please click **IMPORT** to open the following window. Use **Browse...** to find out the saved text file. Then click **Import**. The one you imported will be listed on the Trusted CA Certificate window. Then click **Import** to use the pre-saved file.

Certificate Management >> Trusted CA Certificate

Import X509 Trusted CA Certificate

Select a trusted CA certificate file.

Click **Import** to upload the certification.

For viewing each trusted CA certificate, click **View** to open the certificate detail information window. If you want to delete a CA certificate, choose the one and click **Delete** to remove all the certificate information.

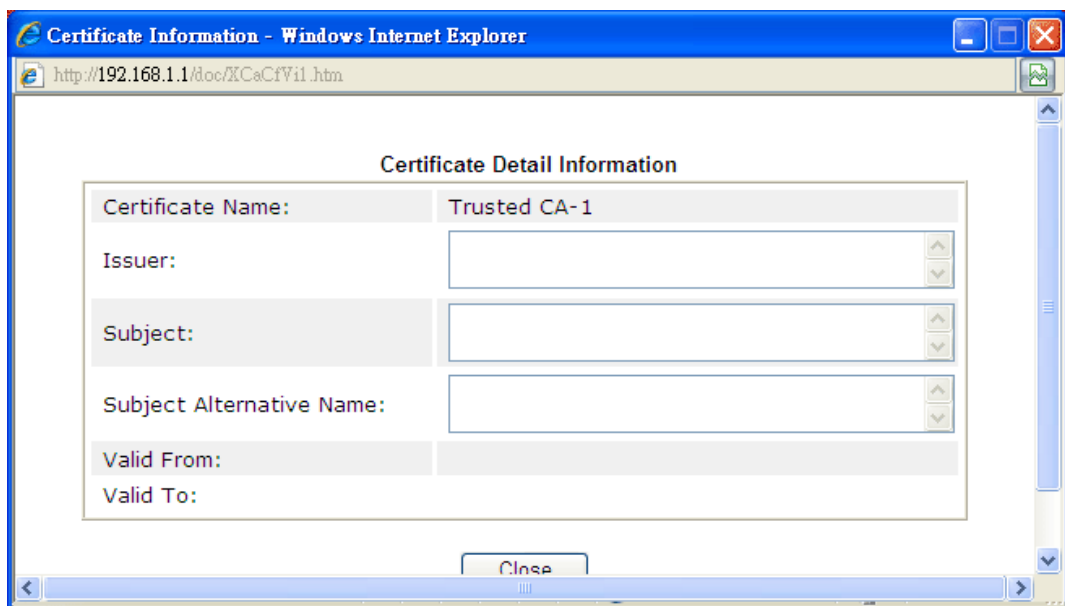

3.10.3 Certificate Backup

Local certificate and Trusted CA certificate for this router can be saved within one file. Please click **Backup** on the following screen to save them. If you want to set encryption password for these certificates, please type characters in both fields of **Encrypt password** and **Retype password**.

Also, you can use **Restore** to retrieve these two settings to the router whenever you want.

Certificate Management >> Certificate Backup

Certificate Backup / Restoration

| |
|-------------------------------------------------------------------------------------------------------------------------------------------------------------------------------------------------------------------------------------------------------------|
| <p>Backup</p> <p>Encrypt password: <input type="text"/></p> <p>Confirm password: <input type="text"/></p> <p>Click <input type="button" value="Backup"/> to download certificates to your local PC as a file.</p> |
| <p>Restoration</p> <p>Select a backup file to restore.</p> <p><input type="text"/> <input type="button" value="Browse.."/></p> <p>Decrypt password: <input type="text"/></p> <p>Click <input type="button" value="Restore"/> to upload the file.</p> |

3.11 VoIP

Note: This function is available Vigor2760Vn only. As with any online service, VoIP/SIP service providers and your account is at risk from fraud. Always use strong passwords for your SIP accounts and regularly check your bill for abnormal activity.

Voice over IP network (VoIP) enables you to use your broadband Internet connection to make toll quality voice calls over the Internet.

There are many different call signaling protocols, methods by which VoIP devices can talk to each other. The most popular protocols are SIP, MGCP, Megaco and H.323. These protocols are not all compatible with each other (except via a soft-switch server).

The Vigor V models support the SIP protocol as this is an ideal and convenient deployment for the ITSP (Internet Telephony Service Provider) and softphone and is widely supported. SIP is an end-to-end, signaling protocol that establishes user presence and mobility in VoIP structure. Every one who wants to talk using his/her SIP Uniform Resource Identifier, "SIP Address". The standard format of SIP URI is

sip: user:password @ host: port

Some fields may be optional in different use. In general, "host" refers to a domain. The "userinfo" includes the user field, the password field and the @ sign following them. This is very similar to a URL so some may call it "SIP URL". SIP supports peer-to-peer direct calling and also calling via a SIP proxy server (a role similar to the gatekeeper in H.323 networks), while the MGCP protocol uses client-server architecture, the calling scenario being very similar to the current PSTN network.

After a call is setup, the voice streams transmit via RTP (Real-Time Transport Protocol). Different codecs (methods to compress and encode the voice) can be embedded into RTP packets. Vigor V models provide various codecs, including G.711 A/ μ -law, G.723, G.726 and G.729 A & B. Each codec uses a different bandwidth and hence provides different levels of voice quality. The more bandwidth a codec uses the better the voice quality, however the codec used must be appropriate for your Internet bandwidth.

Usually there will be two types of calling scenario, as illustrated below:

- **Calling via SIP Servers**

First, the Vigor V models of yours will have to register to a SIP Registrar by sending registration messages to validate. Then, both parties' SIP proxies will forward the sequence of messages to caller to establish the session.

If you both register to the same SIP Registrar, then it will be illustrated as below:

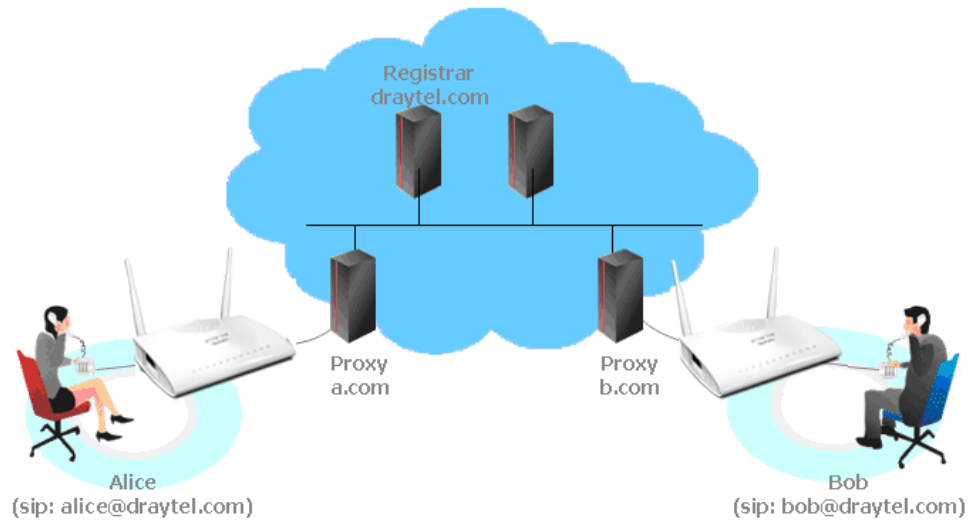

The major benefit of this mode is that you don't have to memorize your friend's IP address, which might change very frequently if it's dynamic. Instead of that, you will only have to use **dial plan** or directly dial your friend's **account name** if you are with the same SIP Registrar.

- **Peer-to-Peer**

Before calling, you have to know your friend's IP Address. The Vigor VoIP Routers will build connection between each other.

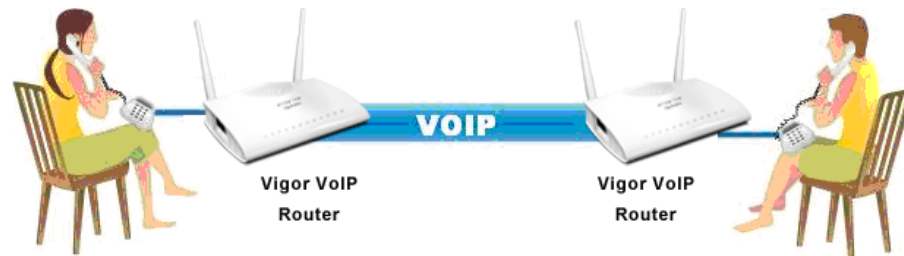

- Our Vigor V models firstly apply efficient codecs designed to make the best use of available bandwidth, but Vigor V models also equip with automatic QoS assurance. QoS Assurance assists to assign high priority to voice traffic via Internet. You will always have the required inbound and outbound bandwidth that is prioritized exclusively for Voice traffic over Internet but you just get your data a little slower and it is tolerable for data traffic.



3.11.1 DialPlan

This page allows you to set phone book, digit map, call barring, regional settings and PSTN setup for the VoIP function. Click the links on this page to access into next pages for detailed settings.

VoIP >> DialPlan Setup

DialPlan Configuration

| |
|---------------------------------------------------------------------------------------------------------------------------------------------------|
| Phone Book Digit Map Call Barring Regional PSTN Setup |
|---------------------------------------------------------------------------------------------------------------------------------------------------|

Phone Book

In this section, you can set your VoIP contacts in the “phonebook”. It can help you to make calls quickly and easily by using “speed-dial” **Phone Number**. There are total 60 index entries in the phonebook for you to store all your friends and family members’ SIP addresses. **Loop through** and **Backup Phone Number** will be displayed if you are using Vigor2830Vn for setting the phone book.

VoIP >> DialPlan Setup

Phone Book

| Index | Phone number | Display Name | SIP URL | Dial Out Account | Loop through | Backup Phone Number | Status |
|---------------------|--------------|--------------|---------|------------------|--------------|---------------------|--------|
| 1. | | | | Default | None | | x |
| 2. | | | | Default | None | | x |
| 3. | | | | Default | None | | x |
| 4. | | | | Default | None | | x |
| 5. | | | | Default | None | | x |
| 6. | | | | Default | None | | x |
| 7. | | | | Default | None | | x |
| 8. | | | | Default | None | | x |
| 9. | | | | Default | None | | x |
| 10. | | | | Default | None | | x |
| 11. | | | | Default | None | | x |
| 12. | | | | Default | None | | x |
| 13. | | | | Default | None | | x |
| 14. | | | | Default | None | | x |
| 15. | | | | Default | None | | x |
| 16. | | | | Default | None | | x |
| 17. | | | | Default | None | | x |
| 18. | | | | Default | None | | x |
| 19. | | | | Default | None | | x |
| 20. | | | | Default | None | | x |

<< [1-20](#) | [21-40](#) | [41-60](#) >>

[Next](#) >>

Status: v --- Active, x --- Inactive

Click any index number to display the dial plan setup page.

Phone Book Index No. 1

Enable

Phone Number:

Display Name:

SIP URL: @

Dial Out Account:

Loop through:

Backup Phone Number:

OK Clear Cancel

Available settings are explained as follows:

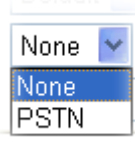
| Item | Description |
|----------------------------|---------------------------------------------------------------------------------------------------------------------------------------------------------------------------------------------------------------------------------------------------------------------------------------------------------------------------------------------------------------------------------------------------------------------------------------------------------------------------------------------------------------------------------------------------------|
| Enable | Click this to enable this entry. |
| Phone Number | The speed-dial number of this index. This can be any number you choose, using digits 0-9 and * . |
| Display Name | The Caller-ID that you want to be displayed on your friend's screen. This let your friend can easily know who's calling without memorizing lots of SIP URL Address. |
| SIP URL | Enter your friend's SIP Address. |
| Dial Out Account | Choose one of the SIP accounts for this profile to dial out. It is useful for both sides (caller and callee) that registered to different SIP Registrar servers. If caller and callee do not use the same SIP server, sometimes, the VoIP phone call connection may not succeed. By using the specified dial out account, the successful connection can be assured. |
| Loop through | Choose PSTN to enable loop through function.  |
| Backup Phone Number | When the VoIP phone is obstructs or the Internet breaks down for some reasons, the backup phone will be dialed out to replace the VoIP phone number. At this time, the phone call will be changed from VoIP phone into PSTN call according to the loop through direction chosen. Note that, during the phone switch, the blare of phone will appear for a short time. And when the VoIP phone is switched into the PSTN phone, the telecom co. might charge you for the connection fee. Please type in backup phone number for this VoIP phone setting. |

After finishing all the settings here, please click **OK** to save the configuration.

Note: If the incoming or outgoing calls do not match any entry on the phonebook, the router will try to make the call "being protected". But, if the call ends up "unprotected"(e.g. peer side does not support ZRTP+SRTP), the router will not play out a warning message.

Digit Map

For the convenience of user, this page allows users to edit prefix number for the SIP account with adding number, stripping number or replacing number. It is used to help user having a quick and easy way to dial out through VoIP interface.

VoIP >> DialPlan Setup i

Digit Map Setup

| # | Enable | Match Prefix | Mode | OP Number | Min Len | Max Len | Route | Move Up | Move Down |
|----|-------------------------------------|--------------|---------|-----------|---------|---------|-------|---------|-----------|
| 1 | <input checked="" type="checkbox"/> | 03 | Replace | 8863 | 7 | 8 | PSTN | | Down |
| 2 | <input checked="" type="checkbox"/> | 886 | Strip | 886 | 9 | 10 | PSTN | UP | Down |
| 3 | <input type="checkbox"/> | | None | | 0 | 0 | PSTN | UP | Down |
| 4 | <input type="checkbox"/> | | None | | 0 | 0 | PSTN | UP | Down |
| 5 | <input type="checkbox"/> | | None | | 0 | 0 | PSTN | UP | Down |
| 6 | <input type="checkbox"/> | | None | | 0 | 0 | PSTN | UP | Down |
| 7 | <input type="checkbox"/> | | None | | 0 | 0 | PSTN | UP | Down |
| 8 | <input type="checkbox"/> | | None | | 0 | 0 | PSTN | UP | Down |
| 9 | <input type="checkbox"/> | | None | | 0 | 0 | PSTN | UP | Down |
| 10 | <input type="checkbox"/> | | None | | 0 | 0 | PSTN | UP | Down |
| 11 | <input type="checkbox"/> | | None | | 0 | 0 | PSTN | UP | Down |
| 12 | <input type="checkbox"/> | | None | | 0 | 0 | PSTN | UP | Down |
| 13 | <input type="checkbox"/> | | None | | 0 | 0 | PSTN | UP | Down |
| 14 | <input type="checkbox"/> | | None | | 0 | 0 | PSTN | UP | Down |
| 15 | <input type="checkbox"/> | | None | | 0 | 0 | PSTN | UP | Down |
| 16 | <input type="checkbox"/> | | None | | 0 | 0 | PSTN | UP | Down |
| 17 | <input type="checkbox"/> | | None | | 0 | 0 | PSTN | UP | Down |
| 18 | <input type="checkbox"/> | | None | | 0 | 0 | PSTN | UP | Down |
| 19 | <input type="checkbox"/> | | None | | 0 | 0 | PSTN | UP | Down |
| 20 | <input type="checkbox"/> | | None | | 0 | 0 | PSTN | UP | Down |

Note:

1. The length for Min Len and Max Len fields should be between 0~25.
2. Wildcard '?' is supported.

Available settings are explained as follows:

| Item | Description |
|---------------------|--------------------------------------------------------------------------------------------------------------------------------------------------------------------------------------------------------------------------------------------------------------------------------------------------------------------------------------------------------------------------------------------------------------------------------------------------------------------------------------------------|
| Enable | Check this box to invoke this setting. |
| Match Prefix | It is used to match with the number you dialed and can be modified with the OP Number by the mode (add, strip or replace). |
| Mode | <p>None - No action.</p> <p>Add - When you choose this mode, the OP number will be added with the prefix number for calling out through the specific VoIP interface.</p> <p>Strip - When you choose this mode, the OP number will be deleted by the prefix number for calling out through the specific VoIP interface. Take the above picture (Prefix Table Setup web page) as an example, the OP number of 886 will be deleted completely for the prefix number is set</p> |

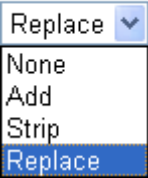
| | |
|---------------------------|--------------------------------------------------------------------------------------------------------------------------------------------------------------------------------------------------------------------------------------------------------------------------------------------------------------------------------------------------------------------------------------------------------------------------------------------------------------------------------------------------|
| | <p>with 886.</p> <p>Replace - When you choose this mode, the OP number will be replaced by the prefix number for calling out through the specific VoIP interface. Take the above picture (Prefix Table Setup web page) as an example, the prefix number of 03 will be replaced by 8863. For example: dial number of “031111111” will be changed to “8863111111” and sent to SIP server.</p> <p>Mode</p>  |
| OP Number | The front number you type here is the first part of the account number that you want to execute special function (according to the chosen mode) by using the prefix number. |
| Min Len | Set the minimal length of the dial number for applying the prefix number settings. Take the above picture (Prefix Table Setup web page) as an example, if the dial number is between 7 and 9, that number can apply the prefix number settings here. |
| Max Len | Set the maximum length of the dial number for applying the prefix number settings. |
| Route | Choose the one that you want to enable the prefix number settings from the saved SIP accounts. Please set up one SIP account first to make this interface available. This item will be changed according to the port settings configured in VoIP>> Phone Settings . |
| Move UP /Move Down | Click the link to move the selected entry up or down. |

After finishing all the settings here, please click **OK** to save the configuration.

Call Barring

Call barring is used to block phone calls coming from the one that is not welcomed.

VoIP >> DialPlan Setup



Call Barring Setup

[Set to Factory Default](#)

| Index | Call Direction | Barring Type | Barring Number/URL/URI | Route | Schedule | Status |
|-------|----------------|--------------|------------------------|-------|----------|--------|
| 1. | | | | | | x |
| 2. | | | | | | x |
| 3. | | | | | | x |
| 4. | | | | | | x |
| 5. | | | | | | x |
| 6. | | | | | | x |
| 7. | | | | | | x |
| 8. | | | | | | x |
| 9. | | | | | | x |
| 10. | | | | | | x |

<< 1-10 | 11-20 >>

[Next >>](#)

Advanced:

[Block Anonymous](#)

[Block Unknown Domain](#)

[Block IP Address](#)

Click any index number to display the dial plan setup page.

VoIP >> DialPlan Setup

Call Barring Index No. 1

Enable

Call Direction: IN

Barring Type: Specific URI/URL

Specific URI/URL:

Route: All

Index(1-15) in **Schedule** Setup: , , ,

Note: Wildcard '?' is supported.

OK

Cancel

Available settings are explained as follows:

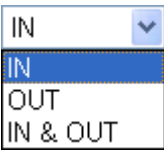
| Item | Description |
|-----------------------|------------------------------------------------------------------------------------------------------------------------------------------------------------------------------------------------------------------------|
| Enable | Check it to enable this entry. |
| Call Direction | Determine the direction for the phone call, IN – incoming call, OUT-outgoing call, IN & OUT – both incoming and outgoing calls.  |

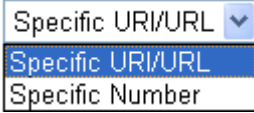
| | |
|--------------------------------------------|---------------------------------------------------------------------------------------------------------------------------------------------------------------------------------------------|
| Barring Type | Determine the type of the VoIP phone call, URI/URL or number.  |
| Specific URI/URL or Specific Number | This field will be changed based on the type you selected for barring Type. |
| Route | All means all the phone calls will be blocked with such mechanism. |
| Index (1-15) in Schedule | Enter the index of schedule profiles to control the call barring according to the preconfigured schedules. Refer to section Applications>>Schedule for detailed configuration. |

Additionally, you can set advanced settings for call barring such as **Block Anonymous**, **Block Unknown Domain** or **Block IP Address**. Simply click the relational links to open the web page.

For **Block Anonymous** – this function can block the incoming calls without caller ID on the interface (Phone port) specified in the following window. Such control also can be done based on preconfigured schedules.

VoIP >> DialPlan Setup

Call Barring Block Anonymous

| | | |
|--------------------------------------|---------------------------------|--------------------------------------------------------------------|
| Route | <input type="checkbox"/> Phone1 | <input type="checkbox"/> Phone2 |
| Index(1-15) in Schedule Setup | <input type="text"/> | <input type="text"/> , <input type="text"/> , <input type="text"/> |

Note:Block the incoming calls which do not have the caller ID.

For **Block Unknown Domain** – this function can block incoming calls (through Phone port) from unrecognized domain that is not specified in SIP accounts. Such control also can be done based on preconfigured schedules.

VoIP >> DialPlan Setup

Call Barring Block Unknown Domain

| | | |
|--------------------------------------|---------------------------------|--------------------------------------------------------------------|
| Route | <input type="checkbox"/> Phone1 | <input type="checkbox"/> Phone2 |
| Index(1-15) in Schedule Setup | <input type="text"/> | <input type="text"/> , <input type="text"/> , <input type="text"/> |

Note:If the domain of the incoming call is different from the domain found in SIP accounts,the call should be blocked.

For **Block IP Address** – this function can block incoming calls (through Phone port) coming from IP address. Such control also can be done based on preconfigured schedules.

VoIP >> DialPlan Setup

Call Barring Block IP Address

| | | |
|--------------------------------------|---------------------------------|-------------------------------------------------------------------------------------------|
| Route | <input type="checkbox"/> Phone1 | <input type="checkbox"/> Phone2 |
| Index(1-15) in Schedule Setup | <input type="text"/> | <input type="text"/> , <input type="text"/> , <input type="text"/> , <input type="text"/> |

Note: The incoming calls by means of IP dialing (e.g. #192*168*1*1#) should be blocked.

Regional

This page allows you to process incoming or outgoing phone calls by regional. Default values (common used in most areas) will be shown on this web page. You *can change* the number based on the region that the router is placed.

VoIP >> DialPlan Setup

Enable Regional | [Set to Factory Default](#) |

| | | | |
|----------------------------|-----------------------------------------------|------------------------------|-----------------------------------------------|
| Last Call Return [Miss]: | <input type="text" value="*69"/> | Last Call Return [Out]: | <input type="text" value="*14"/> |
| Last Call Return [In]: | <input type="text" value="*12"/> | | |
| Call Forward [All] [Act]: | <input type="text" value="*72"/> +number+# | Call Forward [Deact]: | <input type="text" value="*73"/> + # |
| Call Forward [Busy] [Act]: | <input type="text" value="*90"/> +number+# | Call Forward [No Ans] [Act]: | <input type="text" value="*92"/> +number+# |
| Do Not Disturb [Act]: | <input type="text" value="*78"/> + # | Do Not Disturb [Deact]: | <input type="text" value="*79"/> + # |
| Hide caller ID [Act]: | <input type="text" value="*67"/> + # | Hide caller ID [Deact]: | <input type="text" value="*68"/> + # |
| Call Waiting [Act]: | <input type="text" value="*56"/> + # | Call Waiting [Deact]: | <input type="text" value="*57"/> + # |
| Block Anonymous [Act]: | <input type="text" value="*77"/> + # | Block Anonymous [Deact]: | <input type="text" value="*87"/> + # |
| Block Unknow Domain [Act]: | <input type="text" value="*40"/> + # | Block Unknow Domain [Deact]: | <input type="text" value="*04"/> + # |
| Block IP Calls [Act]: | <input type="text" value="*50"/> + # | Block IP Calls [Deact]: | <input type="text" value="*05"/> + # |
| Block Last Calls [Act]: | <input type="text" value="*60"/> + # | | |

Available settings are explained as follows:

| Item | Description |
|--------------------------------|---------------------------------------------------------------------------------------------------------------------------------------------------------------|
| Enable Regional | Check this box to enable this function. |
| Last Call Return [Miss] | Sometimes, people might miss some phone calls. Please dial number typed in this field to know where the last phone call comes from and call back to that one. |
| Last Call Return [In] | You have finished an incoming phone call, however you want to call back again for some reason. Please dial number |

| | |
|-------------------------------------|-----------------------------------------------------------------------------------------------------------------------------------------------|
| | typed in this field to call back to that one. |
| Last Call Return [Out] | Dial the number typed in this field to call the previous outgoing phone call again. |
| Call Forward [All][Act] | Dial the number typed in this field to forward all the incoming calls to the specified place. |
| Call Forward [Deact] | Dial the number typed in this field to release the call forward function. |
| Call Forward [Busy][Act] | Dial the number typed in this field to forward all the incoming calls to the specified place while the phone is busy. |
| Call Forward [No Ans][Act] | Dial the number typed in this field to forward all the incoming calls to the specified place while there is no answer of the connected phone. |
| Do Not Disturb [Act] | Dial the number typed in this field to invoke the function of DND. |
| Do Not Distrub [Deact] | Dial the number typed in this field to release the DND function. |
| Hide caller ID [Act] | Dial the number typed in this field to make your phone number (ID) not displayed on the display panel of remote end. |
| Hide caller ID [Deact] | Dial the number typed in this field to release this function. |
| Call Waiting [Act] | Dial the number typed in this field to make all the incoming calls waiting for your answer. |
| Call Waiting [Deact] | Dial the number typed in this field to release this function. |
| Block Anonymous[Act] | Dial the number typed in this field to block all the incoming calls with unknown ID. |
| Block Anonymous[Deact] | Dial the number typed in this field to release this function. |
| Block Unknown Domain [Act] | Dial the number typed in this field to block all the incoming calls from unknown domain. |
| Block Unknown Domain [Deact] | Dial the number typed in this field to release this function. |
| Block IP Calls [Act] | Dial the number typed in this filed to block all the incoming calls from IP address. |
| Block IP Calls [Deact] | Dial the number typed in this field to release this function. |
| Block Last Calls [Act] | Dial the number typed in this field to block the last incoming phone call. |

After finishing all the settings here, please click **OK** to save the configuration.

PSTN Setup

Some emergency phone (e.g., 911) or special phone cannot be dialed out by using VoIP and can be called out through PSTN line only. To solve this problem, this page allows you to set five sets of PSTN number for dialing without passing through Internet. Check the **Enable** box to make the PSTN number available for dial whenever you need and type the number in the field of **phone number for PSTN relay**.

VoIP >> PSTN Setup

Default phone number for PSTN relay

| Enable | phone number for PSTN relay |
|-------------------------------------|-----------------------------|
| <input checked="" type="checkbox"/> | <input type="text"/> |
| <input type="checkbox"/> | <input type="text"/> |
| <input type="checkbox"/> | <input type="text"/> |
| <input type="checkbox"/> | <input type="text"/> |
| <input type="checkbox"/> | <input type="text"/> |

OK

Cancel

After finishing all the settings here, please click **OK** to save the configuration.

3.11.2 SIP Accounts

In this section, you set up your own SIP settings. When you apply for an account, your SIP service provider will give you an **Account Name** or user name, **SIP Registrar**, **Proxy**, and **Domain name**. (The last three might be the same in some case). Then you can tell your folks your SIP Address as in **Account Name@ Domain name**

As Vigor VoIP Router is turned on, it will first register with Registrar using AuthorizationUser@Domain/Realm. After that, your call will be bypassed by SIP Proxy to the destination using AccountName@Domain/Realm as identity.

Note: Selection items for **Ring Port** will differ according to the router you have.

VoIP >> SIP Accounts ?

SIP Accounts List Refresh

| Index | Profile | Domain/Realm | Proxy | Account Name | Codec | Ring Port | Status |
|-------|---------|--------------|-------|--------------|----------|-----------------------------------------------------------------|--------|
| 1 | | | | --- | G.729A/B | <input type="checkbox"/> Phone1 <input type="checkbox"/> Phone2 | - |
| 2 | | | | --- | G.729A/B | <input type="checkbox"/> Phone1 <input type="checkbox"/> Phone2 | - |
| 3 | | | | --- | G.729A/B | <input type="checkbox"/> Phone1 <input type="checkbox"/> Phone2 | - |
| 4 | | | | --- | G.729A/B | <input type="checkbox"/> Phone1 <input type="checkbox"/> Phone2 | - |
| 5 | | | | --- | G.729A/B | <input type="checkbox"/> Phone1 <input type="checkbox"/> Phone2 | - |
| 6 | | | | --- | G.729A/B | <input type="checkbox"/> Phone1 <input type="checkbox"/> Phone2 | - |

R: success registered on SIP server
 -: fail to register on SIP server

NAT Traversal Setting

| | |
|--------------------|--------------------------------------|
| STUN Server: | <input type="text"/> |
| External IP: | <input type="text"/> |
| SIP PING Interval: | <input type="text" value="150"/> sec |

OK

Available settings are explained as follows:

| Item | Description |
|---------------------|------------------------------------------------------------------------------------------------------------------------------------------------------------------------------------------|
| Index | Click this link to access into next page for setting SIP account. |
| Profile | Display the profile name of the account. |
| Domain/Realm | Display the domain name or IP address of the SIP registrar server. |
| Proxy | Display the domain name or IP address of the SIP proxy server. |
| Account Name | Display the account name of SIP address before @. |
| Codec | Display the codec type for the account. |
| Ring Port | Specify which port will ring when receiving a phone call. |
| Status | Show the status for the corresponding SIP account. R means such account is registered on SIP server successfully. - means the account is failed to register on SIP server. |

| | |
|--------------------------|-----------------------------------------------------------------------------------------|
| STUN Server | Type in the IP address or domain of the STUN server. |
| External IP | Type in the gateway IP address. |
| SIP PING interval | The default value is 150 (sec). It is useful for a Nortel server NAT Traversal Support. |

Click any index link to access into the following page for configuring SIP account.

VoIP >> SIP Accounts

SIP Account Index No. 1

| | |
|------------------------------------------------|-----------------------------------------------------------------|
| Profile Name | <input type="text"/> (11 char max.) |
| Register via | None <input type="checkbox"/> Call without Registration |
| SIP Port | <input type="text" value="5060"/> |
| Domain/Realm | <input type="text"/> (63 char max.) |
| Proxy | <input type="text"/> (63 char max.) |
| <input type="checkbox"/> Act as outbound proxy | |
| Display Name | <input type="text"/> (23 char max.) |
| Account Number/Name | <input type="text" value="---"/> (63 char max.) |
| <input type="checkbox"/> Authentication ID | <input type="text"/> (63 char max.) |
| Password | <input type="text"/> (63 char max.) |
| Expiry Time | 1 hour <input type="text" value="3600"/> sec |
| NAT Traversal Support | None <input type="checkbox"/> |
| Call Forwarding | Disable <input type="checkbox"/> |
| SIP URL | <input type="text"/> |
| Time Out | <input type="text" value="30"/> sec |
| Ring Port | <input type="checkbox"/> Phone1 <input type="checkbox"/> Phone2 |
| Ring Pattern | 1 <input type="checkbox"/> |
| Prefer Codec | G.729A/B (8Kbps) <input type="checkbox"/> Single Codec |
| Packet Size | 20ms <input type="checkbox"/> |
| Voice Active Detector | Off <input type="checkbox"/> |

OK Cancel Clear

Available settings are explained as follows:

| Item | Description |
|---------------------|--------------------------------------------------------------------------------------------------------------------------------------------------------------------------------------------------------------------------------------------------------------------------------------------------------------------------------------------------------------------------------------|
| Profile Name | Assign a name for this profile for identifying. You can type similar name with the domain. For example, if the domain name is <i>draytel.org</i> , then you might set <i>draytel-1</i> in this field. |
| Register via | If you want to make VoIP call without register personal information, please choose None and check the box to achieve the goal. Some SIP server allows user to use VoIP function without registering. For such server, please check the box of Call without Registration . Choosing Auto is recommended. The system will select a proper way for your VoIP call. |

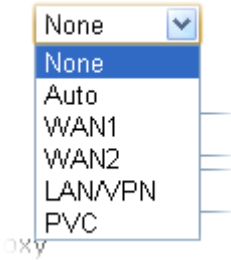
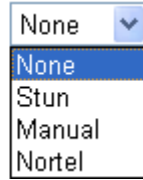
| | |
|------------------------------|---------------------------------------------------------------------------------------------------------------------------------------------------------------------------------------------------------------------------------------------------------------------------------------------------------------------------------------------------------------------------------------------------------------------------------------------------------------------------------------------------------------------------------------------------------------------------------------------------------------------------------------|
| |  |
| SIP Port | Set the port number for sending/receiving SIP message for building a session. The default value is 5060 . Your peer must set the same value in his/her Registrar. |
| Domain/Realm | Set the domain name or IP address of the SIP Registrar server. |
| Proxy | Set domain name or IP address of SIP proxy server. By the time you can type :port number after the domain name to specify that port as the destination of data transmission (e.g., nat.draytel.org:5065) |
| Act as Outbound Proxy | Check this box to make the proxy acting as outbound proxy. |
| Display Name | The caller-ID that you want to be displayed on your friend's screen. |
| Account Number/Name | Enter your account name of SIP Address, e.g. every text before @. |
| Authentication ID | Check the box to invoke this function and enter the name or number used for SIP Authorization with SIP Registrar. If this setting value is the same as Account Name, it is not necessary for you to check the box and set any value in this field. |
| Password | The password provided to you when you registered with a SIP service. |
| Expiry Time | The time duration that your SIP Registrar server keeps your registration record. Before the time expires, the router will send another register request to SIP Registrar again. |
| NAT Traversal Support | <p>If the router (e.g., broadband router) you use connects to internet by other device, you have to set this function for your necessity.</p> <p>NAT Traversal Support </p> <p>None – Disable this function. Stun – Choose this option if there is Stun server provided for your router. Manual – Choose this option if you want to specify an external IP address as the NAT transversal support. Nortel – If the soft-switch that you use supports Nortel solution, you can choose this option.</p> |

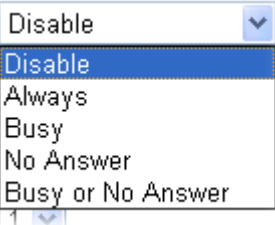
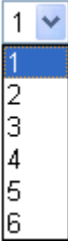
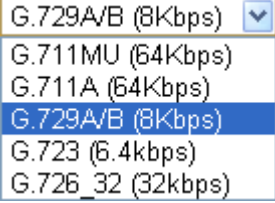
| | |
|-------------------------------|-------------------------------------------------------------------------------------------------------------------------------------------------------------------------------------------------------------------------------------------------------------------------------------------------------------------------------------------------------------------------------------------------------------------------------------------------------------------------------------------------------------------------------------------------------------------------------------------------------------------------------------------------------------------------------------------------------------------------------------------------------|
| <p>Call Forwarding</p> | <p>There are four options for you to choose. Disable is to close call forwarding function. Always means all the incoming calls will be forwarded into SIP URL without any reason. Busy means the incoming calls will be forwarded into SIP URL only when the local system is busy. No Answer means if the incoming calls do not receive any response, they will be forwarded to the SIP URL by the time out.</p>  <p>SIP URL – Type in the SIP URL (e.g., aaa@draytel.org or abc@iptel.org) as the site for call forwarded.</p> <p>Time Out – Set the time out for the call forwarding. The default setting is 30 sec.</p> |
| <p>Ring Port</p> | <p>Set Phone 1 and/or Phone 2 as the default ring port(s) for this SIP account.</p> |
| <p>Ring Pattern</p> | <p>Choose a ring tone type for the VoIP phone call.</p> <p>Ring Pattern </p> |
| <p>Prefer Codec</p> | <p>Select one of five codecs as the default for your VoIP calls. The codec used for each call will be negotiated with the peer party before each session, and so may not be your default choice. The default codec is G.729A/B; it occupies little bandwidth while maintaining good voice quality.</p> <p>If your upstream speed is only 64Kbps, do not use G.711 codec. It is better for you to have at least 256Kbps upstream if you would like to use G.711.</p>  <p>Single Codec – If the box is checked, only the selected Codec will be applied.</p> |
| <p>Packet Size</p> | <p>The amount of data contained in a single packet. The default value is 20 ms, which means the data packet will contain 20 ms voice information.</p> |

| | | |
|------------------------------|----------------------------------------------------------------------------------------------------------------------------------------------------------------------------------------------------------------------------------------------------------|-------------------------------------------------------------------------------------------------------------------------------------------------------------------------------------------------------------------------------------------------------------------------------------------------------------------------------------------------------------------------------------------------------------|
| | Packet Size | <div style="border: 1px solid black; padding: 2px;"> <div style="background-color: #e0e0e0; padding: 2px;">20ms ▾</div> <div style="padding: 2px;">10ms</div> <div style="background-color: #000080; color: white; padding: 2px;">20ms</div> <div style="padding: 2px;">30ms</div> <div style="padding: 2px;">40ms</div> <div style="padding: 2px;">50ms</div> <div style="padding: 2px;">60ms</div> </div> |
| Voice Active Detector | <p>This function can detect if the voice on both sides is active or not. If not, the router will do something to save the bandwidth for other using. Click On to invoke this function; click off to close the function.</p> <p>Voice Active Detector</p> | <div style="border: 1px solid black; padding: 2px;"> <div style="background-color: #e0e0e0; padding: 2px;">Off ▾</div> <div style="background-color: #000080; color: white; padding: 2px;">Off</div> <div style="padding: 2px;">On</div> </div> |

After finishing all the settings here, please click **OK** to save the configuration.

3.11.3 Phone Settings

This page allows user to set phone settings for Phone 1 and Phone 2 respectively. However, it changes slightly according to different model you have.

VoIP >> Phone Settings

| Index | Port | Call Feature | Tone | Gain (Mic/Speaker) | Default SIP Account | DTMF Relay |
|-------|--------|--------------|--------------|--------------------|---------------------|------------|
| 1 | Phone1 | CW,CT, | User Defined | 5/5 | | OutBand |
| 2 | Phone2 | CW,CT, | User Defined | 5/5 | | OutBand |

RTP

Symmetric RTP

Dynamic RTP Port Start

Dynamic RTP Port End

RTP TOS

Available settings are explained as follows:

| Item | Description |
|-------------------|--------------------------------------------------------------------------------------------------------------------------------------------------------------------------------------------------------------------------------------------------------------------------------------------------------------------------------------------------------------------------------------------------------------------------------------------------------------------------------------------------------------------------------------------------------------------------------------------------------------------------------------------------------------|
| Phone List | <p>Port – there are two phone ports provided here for you to configure. Phone1/Phone2 allows you to set general settings for PSTN phones.</p> <p>Call Feature – A brief description for call feature will be shown in this field for your reference.</p> <p>Tone - Display the tone settings that configured in the advanced settings page of Phone Index.</p> <p>Gain - Display the volume gain settings for Mic/Speaker that configured in the advanced settings page of Phone Index.</p> <p>Default SIP Account – “draytel_1” is the default SIP account. You can click the number below the Index field to</p> |

| | |
|-------------------|------------------------------------------------------------------------------------------------------------------------------------------------------------------------------------------------------------------------------------------------------------------------------------------------------------------------------------------------------------------------------------------------------------------------------------------------------------------------------------------------------------------------------------------------------------------------------------------------------------------------------------------------------------------------------------------------------------------------------------------------------------------------------------------------------------------------------------------------------------------------------------------------------------------------------------------------------------------------------------------------------------------------------------------------------------------------------------------------------------------------------------------------------------------------------------------------------------------------------------------------------------------------------------------------------------------------------------------------------------------------------------------------------------------------------------------------------------------------------------------------------------------------------------------------------------------------------------------------------------------------------------------------------------------------------------------------------------------------|
| | <p>change SIP account for each phone port.</p> <p>DTMF Relay – Display DTMF mode that configured in the advanced settings page of Phone Index.</p> |
| <p>RTP</p> | <p>Symmetric RTP – Check this box to invoke the function. To make the data transmission going through on both ends of local router and remote router not misleading due to IP lost (for example, sending data from the public IP of remote router to the private IP of local router), you can check this box to solve this problem.</p> <p>Dynamic RTP Port Start - Specifies the start port for RTP stream. The default value is 10050.</p> <p>Dynamic RTP Port End - Specifies the end port for RTP stream. The default value is 15000.</p> <p>RTP TOS – It decides the level of VoIP package. Use the drop down list to choose any one of them.</p> <div style="display: flex; align-items: center;"> <div style="margin-right: 10px;">RTP TOS</div> <div style="border: 1px solid black; padding: 2px;"> <div style="background-color: #4a7ebb; color: white; padding: 2px;">Manual</div> <ul style="list-style-type: none"> IP precedence 1 IP precedence 2 IP precedence 3 IP precedence 4 IP precedence 5 IP precedence 6 IP precedence 7 AF Class1 (Low Drop) AF Class1 (Medium Drop) AF Class1 (High Drop) AF Class2 (Low Drop) AF Class2 (Medium Drop) AF Class2 (High Drop) AF Class3 (Low Drop) AF Class3 (Medium Drop) AF Class3 (High Drop) AF Class4 (Low Drop) AF Class4 (Medium Drop) AF Class4 (High Drop) EF Class <div style="background-color: #4a7ebb; color: white; padding: 2px; text-align: right;">Manual ▼</div> </div> </div> |

After finishing all the settings here, please click **OK** to save the configuration.

Detailed Settings for Phone Port

Click the number link for Phone port, you can access into the following page for configuring Phone settings.

VoIP >> Phone Settings

Phone1

| | |
|-----------------------------------------------------------------------------------------------------------------------------------------------------------------------------------------------------------------------------------------------------------------------------------------------------------------------------------------------------------------------------------------------------------------------------------------------------------------------------------------------------------------------------------------------------------------------------------------------------------------------------------------------------------------------------------------------------------------------------------------------------------------------------------------------------------------------------------------------------------------------------------------------------------------------------------------|----------------------------------------------------------------------------------------------------------------------------------------------|
| <p>Call Feature</p> <p><input type="checkbox"/> Hotline <input type="text"/></p> <p><input type="checkbox"/> Session Timer <input type="text" value="90"/> sec</p> <p><input type="checkbox"/> T.38 Fax Function</p> <p>Error Correction Mode <input type="text" value="REDUNDANCY"/></p> <p><input type="checkbox"/> DND(Do Not Disturb) Mode</p> <p>Index(1-15) in Schedule Setup:</p> <p><input type="text"/> , <input type="text"/> , <input type="text"/> , <input type="text"/></p> <p>Note: Action and Idle Timeout settings will be ignored.</p> <p>Index(1-60) in Phone Book as Exception List:</p> <p><input type="text"/> , <input type="text"/> , <input type="text"/> , <input type="text"/> , <input type="text"/></p> <p><input type="checkbox"/> CLIR (hide caller ID)</p> <p><input checked="" type="checkbox"/> Call Waiting</p> <p><input checked="" type="checkbox"/> Call Transfer</p> | <p>Default SIP Account <input type="text" value="v"/></p> <p><input type="checkbox"/> Play dial tone only when account registered</p> |
|-----------------------------------------------------------------------------------------------------------------------------------------------------------------------------------------------------------------------------------------------------------------------------------------------------------------------------------------------------------------------------------------------------------------------------------------------------------------------------------------------------------------------------------------------------------------------------------------------------------------------------------------------------------------------------------------------------------------------------------------------------------------------------------------------------------------------------------------------------------------------------------------------------------------------------------------|----------------------------------------------------------------------------------------------------------------------------------------------|

Available settings are explained as follows:

| Item | Description |
|----------------------------------|-------------------------------------------------------------------------------------------------------------------------------------------------------------------------------------------------------------------------------------------------------------------------------------------------------------------------------------------------------------------------------------------------------------------------------------------------------------------------------------------------------------------------------------------------------------------------------------------------------|
| Hotline | Check the box to enable it. Type in the SIP URL in the field for dialing automatically when you pick up the phone set. |
| Session Timer | Check the box to enable the function. In the limited time that you set in this field, if there is no response, the connecting call will be closed automatically. |
| T.38 Fax Function | Check the box to enable T.38 fax function. Error Correction Mode – choose a mode for error correction. |
| DND (Do Not Disturb) mode | Set a period of peace time without disturbing by VoIP phone call. During the period, the one who dial in will listen busy tone, yet the local user will not listen any ring tone. Index (1-15) in Schedule - Enter the index of schedule profiles to control when the phone will ring and when will not according to the preconfigured schedules. Refer to section Application >>Schedule for detailed configuration. Index (1-60) in Phone Book - Enter the index of phone book profiles. Refer to section DialPlan – Phone Book for detailed configuration. |
| CLIR (hide caller ID) | Check this box to hide the caller ID on the display panel of the phone set. |
| Call Waiting | Check this box to invoke this function. A notice sound will appear to tell the user new phone call is waiting for your |

| | |
|----------------------------|---------------------------------------------------------------------------------------------------------------------------------------------------------------------------------------------------------------------------------------------------------------------------------------|
| | response. Click hook flash to pick up the waiting phone call. |
| Call Transfer | Check this box to invoke this function. Click hook flash to initiate another phone call. When the phone call connection succeeds, hang up the phone. The other two sides can communicate, then. |
| Default SIP Account | You can set SIP accounts (up to six groups) on SIP Account page. Use the drop down list to choose one of the profile names for the accounts as the default one for this phone setting. Play dial tone only when account registered - Check this box to invoke the function. |

In addition, you can press the **Advanced** button to configure tone settings, volume gain, MISC and DTMF mode. **Advanced** setting is provided for fitting the telecommunication custom for the local area of the router installed. Wrong tone settings might cause inconvenience for users. To set the sound pattern of the phone set, simply choose a proper region to let the system find out the preset tone settings and caller ID type automatically. Or you can adjust tone settings manually if you choose User Defined. TOn1, TOff1, TOn2 and TOff2 mean the cadence of the tone pattern. TOn1 and TOn2 represent sound-on; TOff1 and TOff2 represent the sound-off.

VoIP >> Phone Settings

Advance Settings >> Phone 1

| Tone Settings | | | | | | |
|----------------------------------------|--------------|---------------|-----------------------------------|----------------|--------------------|----------------|
| Region | User Defined | | Caller ID Type | | | |
| | | | | | | |
| | Low Freq(Hz) | High Freq(Hz) | T on 1 (msec) | T off 1 (msec) | T on 2 (msec) | T off 2 (msec) |
| Dial tone | 350 | 440 | 0 | 0 | 0 | 0 |
| Ringing tone | 400 | 450 | 400 | 200 | 400 | 2000 |
| Busy tone | 400 | 0 | 375 | 375 | 0 | 0 |
| Congestion tone | 0 | 0 | 0 | 0 | 0 | 0 |
| Volume Gain | | | DTMF | | | |
| Mic Gain(1-10) | 5 | | DTMF Mode | | OutBand (RFC2833) | |
| Speaker Gain(1-10) | 5 | | Payload Type (RFC2833) (96 - 127) | | 101 | |
| MISC | | | | | | |
| Dial Tone Power Level (1 - 50) | 27 | | | | | |
| Ring Frequency (10 - 50HZ) | 25 | | | | | |
| Call Waiting Tone Power Level (1 - 30) | 13 | | | | | |
| Interdigit Timeout (1 - 10 sec) | 4 | | | | | |

OK Cancel

Available settings are explained as follows:

| Item | Description |
|---------------|----------------------------------------------------------------------------------------------------------------------------------------------------------------------------------------------------------------------------------------------------------------|
| Region | Select the proper region which you are located. The common settings of Caller ID Type , Dial tone , Ringing tone , Busy tone and Congestion tone will be shown automatically on the page. If you cannot find out a suitable |

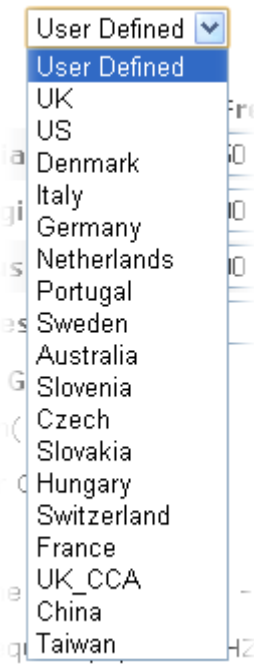
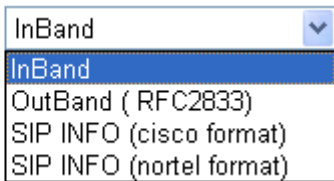
| | |
|---------------------------|------------------------------------------------------------------------------------------------------------------------------------------------------------------------------------------------------------------------------------------------------------------------------------------------------------------------------------------------------------------------------------------------------------------------------------------------------------------------------------------------------------------------------------------------------------------------------------------------------------------------------------------------------------------------------------------------------|
| | <p>one, please choose User Defined and fill out the corresponding values for dial tone, ringing tone, busy tone, congestion tone by yourself for VoIP phone.</p>  <p>Also, you can specify each field for your necessity. It is recommended for you to use the default settings for VoIP communication.</p> |
| <p>Volume Gain</p> | <p>Mic Gain (1-10)/Speaker Gain (1-10) - Adjust the volume of microphone and speaker by entering number from 1- 10. The larger of the number, the louder the volume is.</p> |
| <p>MISC</p> | <p>Dial Tone Power Level - This setting is used to adjust the loudness of the dial tone. The smaller the number is, the louder the dial tone is. It is recommended for you to use the default setting.</p> <p>Ring Frequency - This setting is used to drive the frequency of the ring tone. It is recommended for you to use the default setting.</p> <p>Call Waiting Tone Power Level - This setting is used to adjust the loudness of the call waiting tone. The smaller the number is, the louder the tone is. It is recommended for you to use the default setting.</p> <p>Interdigit Timeout –Type a value in this field to specify time limit for interdigit.</p> |
| <p>DTMF</p> | <p>DTMF Mode – There are four DTMF modes for you to choose.</p> <p>DTMF mode</p>  |

| | |
|--|-----------------------------------------------------------------------------------------------------------------------------------------------------------------------------------------------------------------------------------------------------------------------------------------------------------------------------------------------------------------------------------------------------------------------------------------------------------------------------------------------------------------------------------------------------------------------------------------------------------------------------------------------------------------------------------------------------------------------------------------------------------------------------------------------------------------------------------------------------------------------------------------------------------|
| | <ul style="list-style-type: none"> ● InBand - Choose this one then the Vigor will send the DTMF tone as audio directly when you press the keypad on the phone. ● OutBand - Choose this one then the Vigor will capture the keypad number you pressed and transform it to digital form then send to the other side; the receiver will generate the tone according to the digital form it receive. This function is very useful when the network traffic congestion occurs and it still can remain the accuracy of DTMF tone. ● SIP INFO- Choose this one then the Vigor will capture the DTMF tone and transfer it into SIP form. Then it will be sent to the remote end with SIP message. <p>Payload Type (rfc2833) - Type a number from 96 to 127, the default value was 101. This setting is available for the OutBand (RFC2833) mode.</p> |
|--|-----------------------------------------------------------------------------------------------------------------------------------------------------------------------------------------------------------------------------------------------------------------------------------------------------------------------------------------------------------------------------------------------------------------------------------------------------------------------------------------------------------------------------------------------------------------------------------------------------------------------------------------------------------------------------------------------------------------------------------------------------------------------------------------------------------------------------------------------------------------------------------------------------------|

3.11.4 Status

From this page, you can find codec, connection and other important call status for each port.

VoIP >> Status

Status Refresh Seconds:

| Port | Status | Codec | PeerID | Elapse(hh:mm:ss) | Tx Pkts | Rx Pkts | Rx Loss | Rx Jitter(ms) | In Calls | Out Calls | Miss Calls | Speaker Gain |
|--------|--------|-------|--------|------------------|---------|---------|---------|---------------|----------|-----------|------------|--------------|
| Phone1 | IDLE | | | 00:00:00 | 0 | 0 | 0 | 0 | 0 | 0 | 0 | 5 |
| Phone2 | IDLE | | | 00:00:00 | 0 | 0 | 0 | 0 | 0 | 0 | 0 | 5 |

Log

| Date (mm-dd-yyyy) | Time (hh:mm:ss) | Duration (hh:mm:ss) | In/Out/Miss | Account ID | Peer ID |
|----------------------|--------------------|------------------------|-------------|------------|---------|
| 00-00-0 | 00:00:00 | 00:00:00 | - | - | - |
| 00-00-0 | 00:00:00 | 00:00:00 | - | - | - |
| 00-00-0 | 00:00:00 | 00:00:00 | - | - | - |
| 00-00-0 | 00:00:00 | 00:00:00 | - | - | - |
| 00-00-0 | 00:00:00 | 00:00:00 | - | - | - |
| 00-00-0 | 00:00:00 | 00:00:00 | - | - | - |
| 00-00-0 | 00:00:00 | 00:00:00 | - | - | - |
| 00-00-0 | 00:00:00 | 00:00:00 | - | - | - |
| 00-00-0 | 00:00:00 | 00:00:00 | - | - | - |
| 00-00-0 | 00:00:00 | 00:00:00 | - | - | - |

xxxxxxx : VoIP is encrypted.
xxxxxxx : VoIP isn't encrypted.

Available settings are explained as follows:

| Item | Description |
|------------------------|-----------------------------------------------------------------------------------------------------------------------------------------------------------------|
| Refresh Seconds | Specify the interval of refresh time to obtain the latest VoIP calling information. The information will update immediately when the Refresh button is clicked. |

| | |
|-------------------------|-----------------------------------------------------------------------------------------------------------------------------------------------------------------------------------------------------------------------------------------------------------------------------------------------------------------------------------------------------------------------------------------------------------------------------------------------------------------------------|
| | Refresh Seconds : <input type="text" value="10"/>  <input type="text" value="5"/> <input type="text" value="10"/> <input type="text" value="30"/> |
| Port | It shows current connection status for Phone(s) ports. |
| Status | It shows the VoIP connection status. IDLE - Indicates that the VoIP function is idle. HANG_UP - Indicates that the connection is not established (busy tone). CONNECTING - Indicates that the user is calling out. WAIT_ANS - Indicates that a connection is launched and waiting for remote user's answer. ALERTING - Indicates that a call is coming. ACTIVE -Indicates that the VoIP connection is launched. |
| Codec | Indicates the voice codec employed by present channel. |
| PeerID | The present in-call or out-call peer ID (the format may be IP or Domain). |
| Elapse(hh:mm:ss) | The format is represented as hours:minutes:seconds. |
| Tx Pkts | Total number of transmitted voice packets during this connection session. |
| Rx Pkts | Total number of received voice packets during this connection session. |
| Rx Losts | Total number of lost packets during this connection session. |
| Rx Jitter | The jitter of received voice packets. |
| In Calls | Accumulation for the times of in call. |
| Out Calls | Accumulation for the times of out call. |
| Miss Calls | Accumulation for the times of missing call. |
| Speaker Gain | The volume of present call. |
| Log | Display logs of VoIP calls. |

3.12 Wireless LAN

This function is used for “n” models only.

3.12.1 Basic Concepts

Over recent years, the market for wireless communications has enjoyed tremendous growth. Wireless technology now reaches or is capable of reaching virtually every location on the surface of the earth. Hundreds of millions of people exchange information every day via wireless communication products. The Vigor “n” model, a.k.a. Vigor wireless router, is designed for maximum flexibility and efficiency of a small office/home. Any authorized staff can bring a built-in WLAN client PDA or notebook into a meeting room for conference without laying a clot of LAN cable or drilling holes everywhere. Wireless LAN enables high mobility so WLAN users can simultaneously access all LAN facilities just like on a wired LAN as well as Internet access.

The Vigor wireless routers are equipped with a wireless LAN interface compliant with the standard IEEE 802.11n draft 2 protocol. To boost its performance further, the Vigor Router is also loaded with advanced wireless technology to lift up data rate up to 300 Mbps*. Hence, you can finally smoothly enjoy stream music and video.

Note: * The actual data throughput will vary according to the network conditions and environmental factors, including volume of network traffic, network overhead and building materials.

In an Infrastructure Mode of wireless network, Vigor wireless router plays a role as an Access Point (AP) connecting to lots of wireless clients or Stations (STA). All the STAs will share the same Internet connection via Vigor wireless router. The **General Settings** will set up the information of this wireless network, including its SSID as identification, located channel etc.

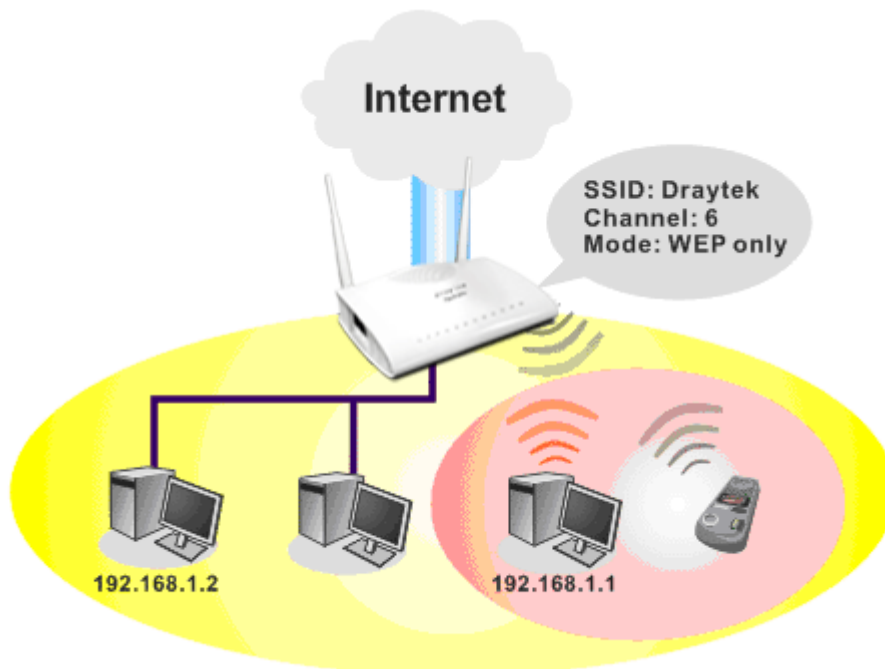

Multiple SSIDs

Vigor router supports four SSID settings for wireless connections. Each SSID can be defined with different name and download/upload rate for selecting by stations connected to the router wirelessly.

Security Overview

Real-time Hardware Encryption: Vigor Router is equipped with a hardware AES encryption engine so it can apply the highest protection to your data without influencing user experience.

Complete Security Standard Selection: To ensure the security and privacy of your wireless communication, we provide several prevailing standards on market.

WEP (Wired Equivalent Privacy) is a legacy method to encrypt each frame transmitted via radio using either a 64-bit or 128-bit key. Usually access point will preset a set of four keys and it will communicate with each station using only one out of the four keys.

WPA (Wi-Fi Protected Access), the most dominating security mechanism in industry, is separated into two categories: WPA-personal or called WPA Pre-Share Key (WPA/PSK), and WPA-Enterprise or called WPA/802.1x.

In WPA-Personal, a pre-defined key is used for encryption during data transmission. WPA applies Temporal Key Integrity Protocol (TKIP) for data encryption while WPA2 applies AES. The WPA-Enterprise combines not only encryption but also authentication.

Since WEP has been proved vulnerable, you may consider using WPA for the most secure connection. You should select the appropriate security mechanism according to your needs. No matter which security suite you select, they all will enhance the over-the-air data protection and /or privacy on your wireless network. The Vigor wireless router is very flexible and can support multiple secure connections with both WEP and WPA at the same time.

Separate the Wireless and the Wired LAN- WLAN Isolation enables you to isolate your wireless LAN from wired LAN for either quarantine or limit access reasons. To isolate means neither of the parties can access each other. To elaborate an example for business use, you may set up a wireless LAN for visitors only so they can connect to Internet without hassle of the confidential information leakage. For a more flexible deployment, you may add filters of MAC addresses to isolate users' access from wired LAN.

Manage Wireless Stations - Station List will display all the station in your wireless network and the status of their connection.



3.12.2 General Setup

By clicking the **General Settings**, a new web page will appear so that you could configure the SSID and the wireless channel. Please refer to the following figure for more information.

Wireless LAN(2.4GHz) >> General Setup

General Setting (IEEE 802.11)

Enable Wireless LAN

Mode :

Channel:

| | Enable | Hide SSID | SSID | Isolate Member | Isolate VPN |
|---|--------------------------|--------------------------|--------------------------------------------|--------------------------|--------------------------|
| 1 | <input type="checkbox"/> | <input type="checkbox"/> | <input type="text" value="DrayTek"/> | <input type="checkbox"/> | <input type="checkbox"/> |
| 2 | <input type="checkbox"/> | <input type="checkbox"/> | <input type="text" value="DrayTek_Guest"/> | <input type="checkbox"/> | <input type="checkbox"/> |
| 3 | <input type="checkbox"/> | <input type="checkbox"/> | <input type="text"/> | <input type="checkbox"/> | <input type="checkbox"/> |
| 4 | <input type="checkbox"/> | <input type="checkbox"/> | <input type="text"/> | <input type="checkbox"/> | <input type="checkbox"/> |

Note:
Enabling the Isolate Member configuration will forbid the wireless clients associated to the same SSID from connecting to each other.

The isolate VPN configuration will isolate the wireless traffic from VPN connections and thus, wireless clients will not be able to access the VPN network under this setting.

Rate Control

| | Enable | Upload | Download |
|--------|--------------------------|-----------------------------------------|-----------------------------------------|
| SSID 1 | <input type="checkbox"/> | <input type="text" value="30000"/> kbps | <input type="text" value="30000"/> kbps |
| SSID 2 | <input type="checkbox"/> | <input type="text" value="30000"/> kbps | <input type="text" value="30000"/> kbps |
| SSID 3 | <input type="checkbox"/> | <input type="text" value="30000"/> kbps | <input type="text" value="30000"/> kbps |
| SSID 4 | <input type="checkbox"/> | <input type="text" value="30000"/> kbps | <input type="text" value="30000"/> kbps |

Note:
Configurable upload and download rates are from 100 to 50,000(kbps).

Associated Schedule Profiles: , , ,

Note:
Only schedule profiles that have the action "Force Down" are applied to the WLAN, all other actions are ignored. Valid settings are profile indexes 1 to 15.

Available settings are explained as follows:

| Item | Description |
|----------------------------|---------------------------------------------------------------------------------------------------------------------------------------------------------------------------------------------------------|
| Enable Wireless LAN | Check the box to enable wireless function. |
| Mode | At present, the router can connect to 11b Only, 11g Only, 11n Only(2.4 GHz), Mixed (11b+11g), Mixed (11g+11n), and Mixed (11b+11g+11n) stations simultaneously. Simply choose Mixed (11b+11g+11n) mode. |

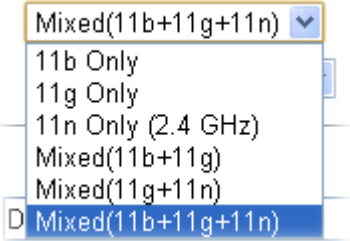
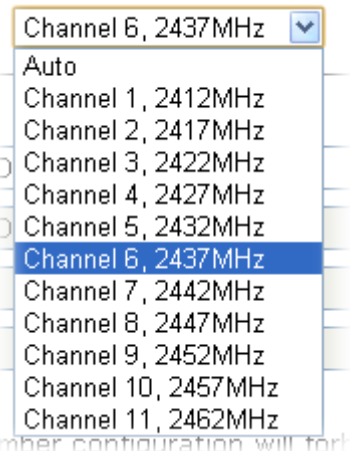
| | |
|---------------------|-----------------------------------------------------------------------------------------------------------------------------------------------------------------------------------------------------------------------------------------------------------------------------------------------------------------------------------------------------------------------------------------------------------------------------------------------------------------|
| |  |
| Channel | <p>Means the channel of frequency of the wireless LAN. The default channel is 6. You may switch channel if the selected channel is under serious interference. If you have no idea of choosing the frequency, please select Auto to let system determine for you.</p>  |
| Hide SSID | <p>Check it to prevent from wireless sniffing and make it harder for unauthorized clients or STAs to join your wireless LAN. Depending on the wireless utility, the user may only see the information except SSID or just cannot see any thing about Vigor wireless router while site surveying. The system allows you to set four sets of SSID for different usage. In default, the first set of SSID will be enabled. You can hide it for your necessity.</p> |
| SSID | <p>Means the identification of the wireless LAN. SSID can be any text numbers or various special characters.</p> |
| Isolate | <p>Member – Check this box to make the wireless clients (stations) with the same SSID not accessing for each other. VPN – Check this box to make the wireless clients (stations) with different VPN not accessing for each other.</p> |
| Rate Control | <p>It controls the data transmission rate through wireless connection.</p> <p>Upload – Check Enable and type the transmitting rate for data upload. Default value is 30,000 kbps. Download – Type the transmitting rate for data download. Default value is 30,000 kbps.</p> |
| Schedule | <p>Set the wireless LAN to work at certain time interval only. You may choose up to 4 schedules out of the 15 schedules</p> |

| | |
|--|-------------------------------------------------------------------------------------------------------------------------------------------|
| | pre-defined in Applications >> Schedule setup. The default setting of this field is blank and the function will always work. |
|--|-------------------------------------------------------------------------------------------------------------------------------------------|

After finishing all the settings here, please click **OK** to save the configuration.

3.12.3 Security

This page allows you to set security with different modes for SSID 1, 2, 3 and 4 respectively. After configuring the correct settings, please click **OK** to save and invoke it.

The password (PSK) of default security mode is provided and stated on the label pasted on the bottom of the router. For the wireless client who wants to access into Internet through such router, please input the default PSK value for connection.

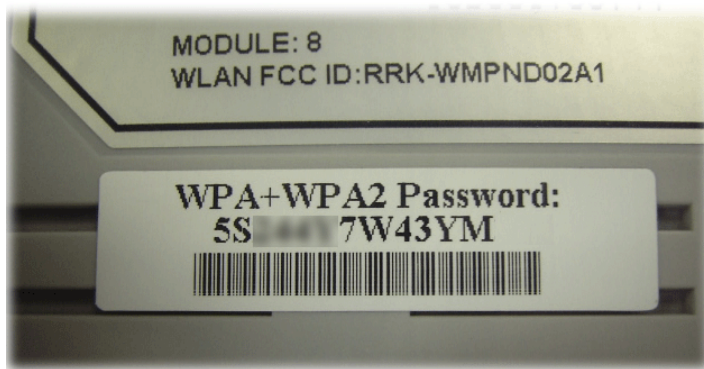

| |
|-------------------------------------------------------------------------------------------------------------------------------------------------------------------------------------------------|
| <p>Note: All wireless devices must support the same encryption bit length and share the same key. If WEP mode is selected, only one of four preset keys can be selected at one time.</p> |
|-------------------------------------------------------------------------------------------------------------------------------------------------------------------------------------------------|

By clicking the **Security Settings**, a new web page will appear so that you could configure the settings of WPA and WEP.

Wireless LAN >> Security Settings

| SSID 1 | SSID 2 | SSID 3 | SSID 4 |
|--------------------------------------------------------------------------------------------------------------------------------------------------------------------------------------------------------------------------------------------------------------------------------------------------------------------------------------------------------------------------------------------------------------------------------------------------------------------------------------------------------------------------------------------------------------------------------------------------------------------------------------------------------------------------------------------------------------------------------------------------------------------------------------------------------------------------------------------------------------------------------------------------------------------------------------------------------------------------------------------------------------------------------------------|--------|--------|--------|
| <p>Mode: Mixed(WPA+WPA2)/PSK ▾</p> <p><u>WPA</u></p> <p>Encryption Mode: TKIP for WPA/AES for WPA2</p> <p>Pre-Shared Key(PSK): <input type="text" value="*****"/></p> <p>Type 8~63 ASCII character or 64 Hexadecimal digits leading by "0x", for example "cfgs01a2..." or "0x655abcd....".</p> <p><u>WEP</u></p> <p>Encryption Mode: 64-Bit ▾</p> <p><input checked="" type="radio"/> Key 1 : <input type="text" value="*****"/></p> <p><input type="radio"/> Key 2 : <input type="text" value="*****"/></p> <p><input type="radio"/> Key 3 : <input type="text" value="*****"/></p> <p><input type="radio"/> Key 4 : <input type="text" value="*****"/></p> <p>Note:</p> <p>For 64 bit WEP key configurations, please insert 5 ASCII characters or 10 Hexadecimal digits leading by "0x". Examples are "AB312" or "0x4142333132".</p> <p>For 128 bit WEP key configurations, please insert 13 ASCII characters or 26 Hexadecimal digits leading by "0x".</p> | | | |
| <p><input type="button" value="OK"/> <input type="button" value="Cancel"/></p> | | | |

Available settings are explained as follows:

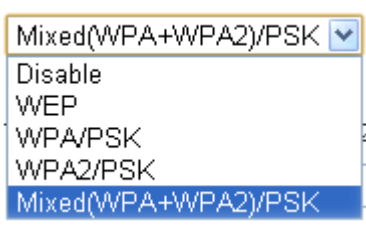
| Item | Description |
|-------------|-------------------------------------------------------------------------------------------------------------------------------------------------------------------------------------------------------------------------------------------------------------------------------------------------------------------------------------------------------------------------------------------------------------------------------------------------------------------------------------------------------------------------------------------------------------------------------------------------------------------------------------------------|
| Mode | <p>There are several modes provided for you to choose.</p>  <p>Disable - Turn off the encryption mechanism.</p> <p>WEP-Accepts only WEP clients and the encryption key should be entered in WEP Key.</p> <p>WPA/PSK-Accepts only WPA clients and the encryption key should be entered in PSK.</p> <p>WPA2/PSK-Accepts only WPA2 clients and the encryption key should be entered in PSK.</p> <p>Mixed (WPA+ WPA2)/PSK - Accepts WPA and WPA2 clients simultaneously and the encryption key should be entered in PSK.</p> |
| WPA | <p>The WPA encrypts each frame transmitted from the radio using the key, which either PSK (Pre-Shared Key) entered manually in this field below or automatically negotiated via 802.1x authentication. Either 8~63 ASCII characters, such as 012345678(or 64 Hexadecimal digits leading by 0x, such</p> |

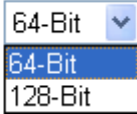
| | |
|------------|-------------------------------------------------------------------------------------------------------------------------------------------------------------------------------------------------------------------------------------------------------------------------------------------------------------------------------------------------------------------------------------------------------------------------------------------------------------------------------------------------------------------------------------------------------------------------------------------------------------------------------------------------------------------------------------------------------------------------------------|
| | <p>as "0x321253abcde...").</p> <p>Type - Select from Mixed (WPA+WPA2) or WPA2 only.</p> <p>Pre-Shared Key (PSK) - Either 8~63 ASCII characters, such as 012345678..(or 64 Hexadecimal digits leading by 0x, such as "0x321253abcde...").</p> |
| WEP | <p>64-Bit - For 64 bits WEP key, either 5 ASCII characters, such as 12345 (or 10 hexadecimal digitals leading by 0x, such as 0x4142434445.)</p> <p>128-Bit - For 128 bits WEP key, either 13 ASCII characters, such as ABCDEFGHIJKLM (or 26 hexadecimal digits leading by 0x, such as 0x4142434445464748494A4B4C4D).</p> <p>Encryption Mode: </p> <p>All wireless devices must support the same WEP encryption bit size and have the same key. Four keys can be entered here, but only one key can be selected at a time. The keys can be entered in ASCII or Hexadecimal. Check the key you wish to use.</p> |

After finishing all the settings here, please click **OK** to save the configuration.

3.12.4 Access Control

In the **Access Control**, the router may restrict wireless access to certain wireless clients only by locking their MAC address into a black or white list. The user may block wireless clients by inserting their MAC addresses into a black list, or only let them be able to connect by inserting their MAC addresses into a white list.

In the **Access Control** web page, users may configure the **white/black** list modes used by each SSID and the MAC addresses applied to their lists.

Wireless LAN(2.4GHz) >> Access Control

Access Control

Enable Mac Address Filter SSID 1 White List SSID 2 White List
 SSID 3 White List SSID 4 White List

MAC Address Filter

| Index | Attribute | MAC Address | Apply SSID |
|-------|-----------|-------------|------------|
| | | | |

Client's MAC Address : : : : : :

Apply SSID : SSID 1 SSID 2 SSID 3 SSID 4

Attribute : s: Isolate the station from LAN

Available settings are explained as follows:

| Item | Description |
|----------------------------------|--------------------------------------------------------------------------------------------------------------------------------------------------------------------------------------------------------------------------------------------------------------------------------------------------------------------------|
| Enable Mac Address Filter | Select to enable the MAC Address filter for wireless LAN identified with SSID 1 to 4 respectively. All the clients (expressed by MAC addresses) listed in the box can be grouped under different wireless LAN. For example, they can be grouped under SSID 1 and SSID 2 at the same time if you check SSID 1 and SSID 2. |
| MAC Address Filter | Display all MAC addresses that are edited before. |
| Client's MAC Address | Manually enter the MAC address of wireless client. |
| Apply SSID | After entering the client's MAC address, check the box of the SSIDs desired to insert this MAC address into their access control list. |
| Attribute | s: Isolate the station from LAN - select to isolate the wireless connection of the wireless client of the MAC address from LAN. |
| Add | Add a new MAC address into the list. |
| Delete | Delete the selected MAC address in the list. |

| | |
|------------------|--------------------------------------------|
| Edit | Edit the selected MAC address in the list. |
| Cancel | Give up the access control set up. |
| OK | Click it to save the access control list. |
| Clear All | Clean all entries in the MAC address list. |

After finishing all the settings here, please click **OK** to save the configuration.

3.12.5 WPS

WPS (Wi-Fi Protected Setup) provides easy procedure to make network connection between wireless station and wireless access point (vigor router) with the encryption of WPA and WPA2.

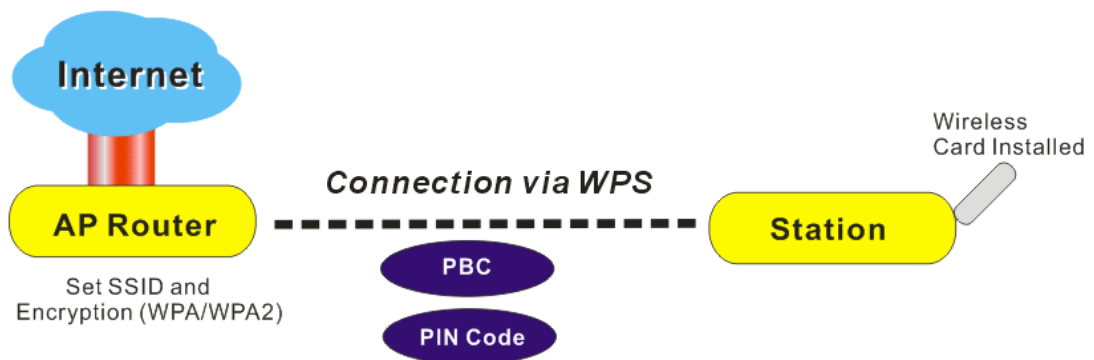

Note: Such function is available for the wireless station with WPS supported.

It is the simplest way to build connection between wireless network clients and vigor router. Users do not need to select any encryption mode and type any long encryption passphrase to setup a wireless client every time. He/she only needs to press a button on wireless client, and WPS will connect for client and router automatically.

There are two methods to do network connection through WPS between AP and Stations: pressing the *Start PBC* button or using *PIN Code*.

- On the side of Vigor 2760 series which served as an AP, press **WPS** button once on the front panel of the router or click **Start PBC** on web configuration interface. On the side of a station with network card installed, press **Start PBC** button of network card.

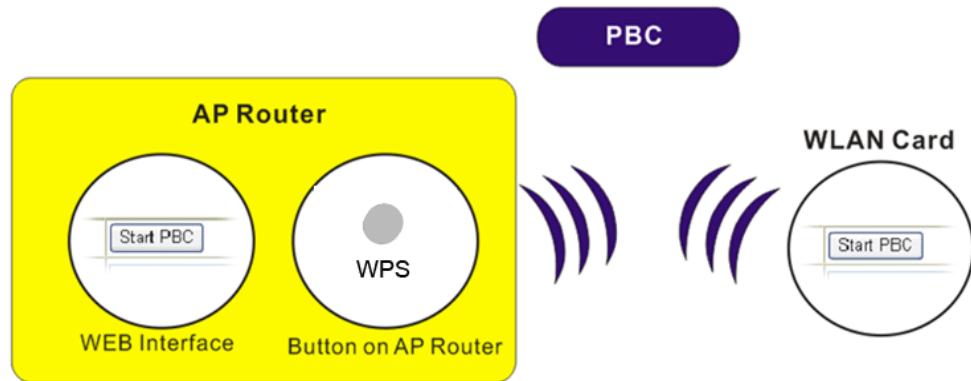

- If you want to use PIN code, you have to know the PIN code specified in wireless client. Then provide the PIN code of the wireless client you wish to connect to the vigor router.

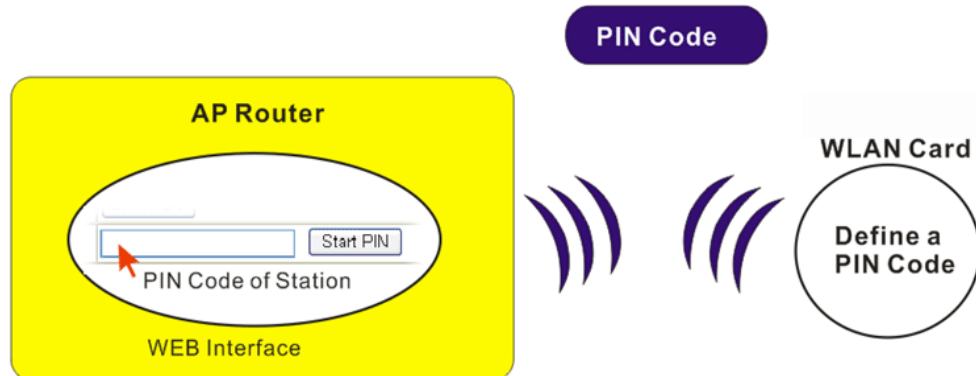

For WPS is supported in WPA-PSK or WPA2-PSK mode, if you do not choose such mode in **Wireless LAN>>Security**, you will see the following message box.

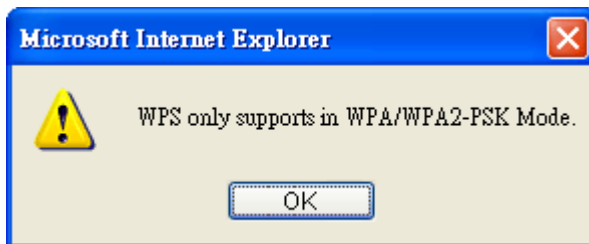

Please click **OK** and go back **Wireless LAN>>Security** to choose WPA-PSK or WPA2-PSK mode and access WPS again.

Below shows **Wireless LAN>>WPS** web page:

Wireless LAN >> WPS (Wi-Fi Protected Setup)

Enable WPS 

Wi-Fi Protected Setup Information

| | |
|----------------------------|---------------------|
| WPS Status | Configured |
| SSID | DrayTek |
| Authentication Mode | Mixed(WPA+WPA2)/PSK |

Device Configure

| | |
|-------------------------------------|---------------------------------------------------------------|
| Configure via Push Button | <input type="button" value="Start PBC"/> |
| Configure via Client PinCode | <input type="text"/> <input type="button" value="Start PIN"/> |

Status: Ready

Note: WPS can help your wireless client automatically connect to the Access point.

: WPS is Disabled.

: WPS is Enabled.

: Waiting for WPS requests from wireless clients.

Available settings are explained as follows:

| Item | Description |
|-------------------------------------|----------------------------------------------------------------------------------------------------------------------------------------------------------------------------------------------------------------------------------------------------------------------------------------------------------------------------|
| Enable WPS | Check this box to enable WPS setting. |
| WPS Status | Display related system information for WPS. If the wireless security (encryption) function of the router is properly configured, you can see 'Configured' message here. |
| SSID | Display the SSID1 of the router. WPS is supported by SSID1 only. |
| Authentication Mode | Display current authentication mode of the router. Only WPA2/PSK and WPA/PSK support WPS. |
| Configure via Push Button | Click Start PBC to invoke Push-Button style WPS setup procedure. The router will wait for WPS requests from wireless clients about two minutes. The WPS LED on the router will blink fast when WPS is in progress. It will return to normal condition after two minutes. (You need to setup WPS within two minutes) |
| Configure via Client PinCode | Please input the PIN code specified in wireless client you wish to connect, and click Start PIN button. The WPS LED on the router will blink fast when WPS is in progress. It will return to normal condition after two minutes. (You need to setup WPS within two minutes) |

3.12.6 WDS

WDS means Wireless Distribution System. It is a protocol for connecting two access points (AP) wirelessly. Usually, it can be used for the following application:

- Provide bridge traffic between two LANs through the air.
- Extend the coverage range of a WLAN.

To meet the above requirement, two WDS modes are implemented in Vigor router. One is **Bridge**, the other is **Repeater**. Below shows the function of WDS-bridge interface:

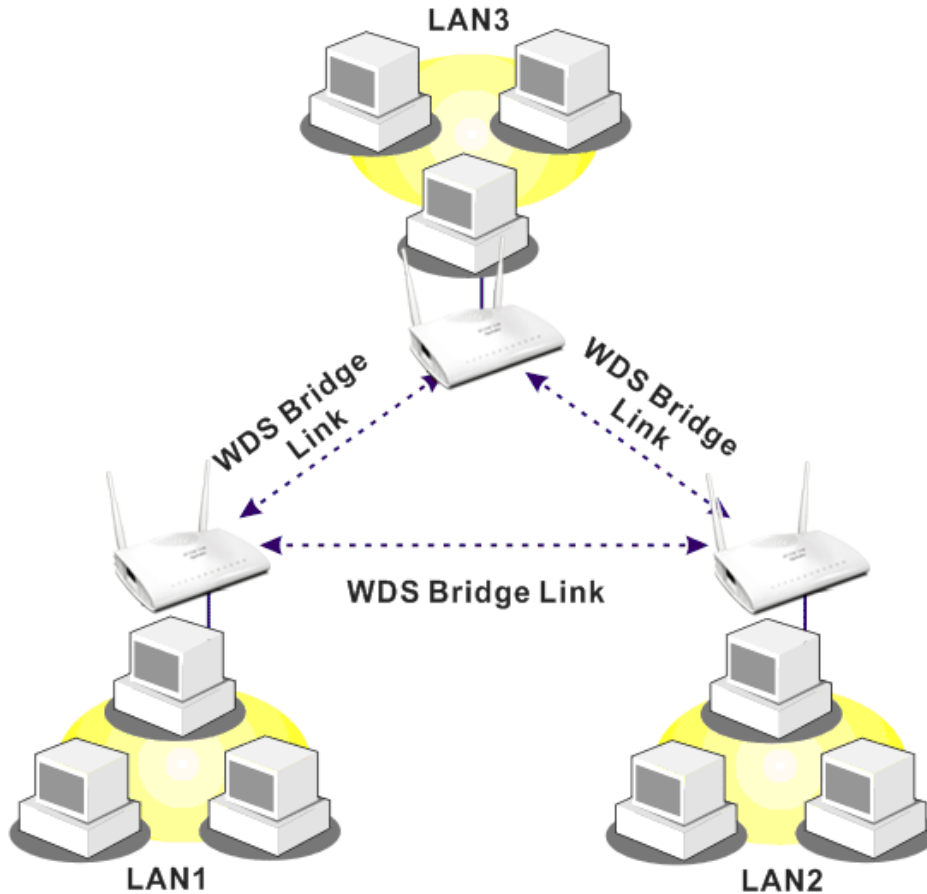

The application for the WDS-Repeater mode is depicted as below:

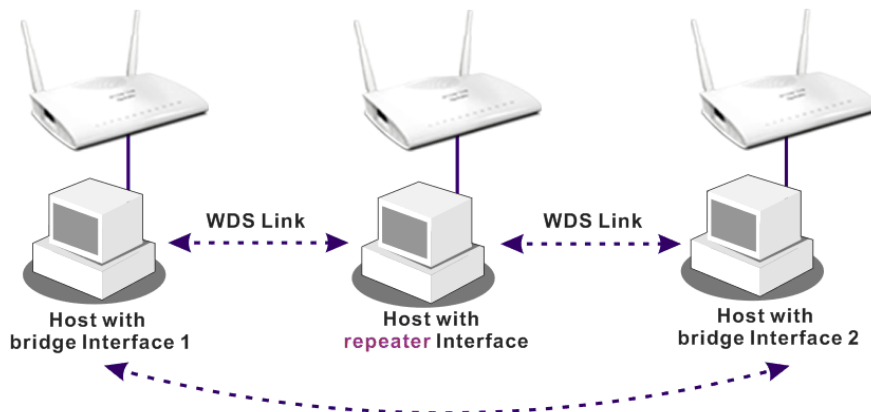

The major difference between these two modes is that: while in **Repeater** mode, the packets received from one peer AP can be repeated to another peer AP through WDS links. Yet in **Bridge** mode, packets received from a WDS link will only be forwarded to local wired or wireless hosts. In other words, only Repeater mode can do WDS-to-WDS packet forwarding.

In the following examples, hosts connected to Bridge 1 or 3 can communicate with hosts connected to Bridge 2 through WDS links. However, hosts connected to Bridge 1 CANNOT communicate with hosts connected to Bridge 3 through Bridge 2.

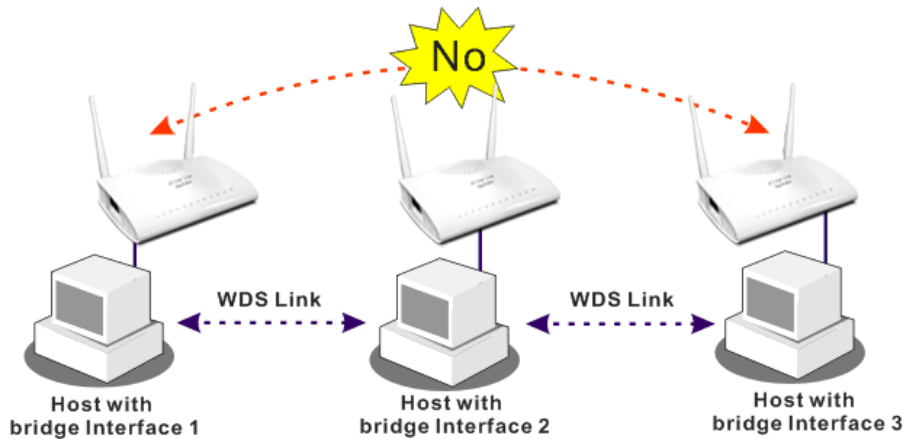

Click **WDS** from **Wireless LAN** menu. The following page will be shown.

WDS Settings
| [Set to Factory Default](#) |

| | | | | | | | | | | | | | | | | | | | | | | | | | | | | | | | | | | | | | | | | | | | | | | | | | | | | | | | | | | | | | | | | | | | | | | | | | | | | | | | | | | | | | | | | | | | | | | | | | |
|------------------------------------------------------------------------------------------------------------------------------------------------------------------------------------------------------------------------------------------------------------------------------------------------------------------------------------------------------------------------------------------------------------------------------------------------------------------------------------------------------------------------------------------------------------------------------------------------------------------------------------------------------------------------------------------------------------------------------------------------------------------------------------------|---------------------------------------------------------------------------------------------------------------------------------------------------------------------------------------------------------------------------------------------------------------------------------------------------------------------------------------------------------------------------------------------------------------------------------------------------------------------------------------------------------------------------------------------------------------------------------------------------------------------------------------------------------------------------------------------------------------------------------------------------------------------------------------------------------------------------------------------------------------------------------------------------------------------------------------------------------------------------------------------------------------------------------------------------------------------------------------------------------------------------------------------------------------------------------------------------------------------------------------------------------------------------------------------------------------------------------------------------------------------------------------------------------------------------------------------------------------------------------------------------------------------------------------------------------------------------------------------------------------------------------------------------------------------------------------------------------------------------------------------------------------------------------------------------------------------------------------------------------------------------------------------------------------------------------------------------------------------------------------------------------------------------------------------------------------------------------------------------------------------------------------------------------------------------------------------------------------------------------------------------------------------------------------------------------------------------------------------------------------------------------------------------------------------------------------------------------------------------------------------------------------------------------------------------------------------------------------------------------------------------------------------------------------------------------------------------------------------------------------------------------------------------------------------------------------------------------------------------------------------------------------------------------------------------------------------------------------------------------------------------------------------------------------------------------------------------------|--------------------------|----------------------|---|----------------------|---|----------------------|---|----------------------|---|----------------------|---|----------------------|--------------------------|----------------------|---|----------------------|---|----------------------|---|----------------------|---|----------------------|---|----------------------|--------------------------|----------------------|---|----------------------|---|----------------------|---|----------------------|---|----------------------|---|----------------------|--------------------------|----------------------|---|----------------------|---|----------------------|---|----------------------|---|----------------------|---|----------------------|--------------------------|----------------------|---|----------------------|---|----------------------|---|----------------------|---|----------------------|---|----------------------|--------------------------|----------------------|---|----------------------|---|----------------------|---|----------------------|---|----------------------|---|----------------------|--------------------------|----------------------|---|----------------------|---|----------------------|---|----------------------|---|----------------------|---|----------------------|--------------------------|----------------------|---|----------------------|---|----------------------|---|----------------------|---|----------------------|---|----------------------|
| <p>Mode: Repeater</p> <hr/> <p>Security:</p> <p> <input type="radio"/> Disable <input type="radio"/> WEP <input checked="" type="radio"/> Pre-shared Key </p> <hr/> <p>WEP:</p> <p>Use the same WEP key set in Security Settings.</p> <hr/> <p>Pre-shared Key:</p> <p>Type:</p> <p> <input checked="" type="radio"/> DrayTek WPA <input type="radio"/> WPA <input type="radio"/> WPA2 </p> <p>Key : <input style="width: 100px;" type="text" value="*****"/></p> <p><small>Type 8~63 ASCII characters or 64 hexadecimal digits leading by "0x", for example "cfgs01a2..." or "0x655abcd....".</small></p> | <p>Bridge</p> <p>Enable <input type="checkbox"/></p> <p>Peer MAC Address</p> <table style="width: 100%; border-collapse: collapse;"> <tr><td><input type="checkbox"/></td><td><input type="text"/></td><td>:</td><td><input type="text"/></td><td>:</td><td><input type="text"/></td><td>:</td><td><input type="text"/></td><td>:</td><td><input type="text"/></td><td>:</td><td><input type="text"/></td></tr> <tr><td><input type="checkbox"/></td><td><input type="text"/></td><td>:</td><td><input type="text"/></td><td>:</td><td><input type="text"/></td><td>:</td><td><input type="text"/></td><td>:</td><td><input type="text"/></td><td>:</td><td><input type="text"/></td></tr> <tr><td><input type="checkbox"/></td><td><input type="text"/></td><td>:</td><td><input type="text"/></td><td>:</td><td><input type="text"/></td><td>:</td><td><input type="text"/></td><td>:</td><td><input type="text"/></td><td>:</td><td><input type="text"/></td></tr> <tr><td><input type="checkbox"/></td><td><input type="text"/></td><td>:</td><td><input type="text"/></td><td>:</td><td><input type="text"/></td><td>:</td><td><input type="text"/></td><td>:</td><td><input type="text"/></td><td>:</td><td><input type="text"/></td></tr> </table> <p><small>Note: Disable unused links to get better performance.</small></p> <hr/> <p>Repeater</p> <p>Enable <input type="checkbox"/></p> <p>Peer MAC Address</p> <table style="width: 100%; border-collapse: collapse;"> <tr><td><input type="checkbox"/></td><td><input type="text"/></td><td>:</td><td><input type="text"/></td><td>:</td><td><input type="text"/></td><td>:</td><td><input type="text"/></td><td>:</td><td><input type="text"/></td><td>:</td><td><input type="text"/></td></tr> <tr><td><input type="checkbox"/></td><td><input type="text"/></td><td>:</td><td><input type="text"/></td><td>:</td><td><input type="text"/></td><td>:</td><td><input type="text"/></td><td>:</td><td><input type="text"/></td><td>:</td><td><input type="text"/></td></tr> <tr><td><input type="checkbox"/></td><td><input type="text"/></td><td>:</td><td><input type="text"/></td><td>:</td><td><input type="text"/></td><td>:</td><td><input type="text"/></td><td>:</td><td><input type="text"/></td><td>:</td><td><input type="text"/></td></tr> <tr><td><input type="checkbox"/></td><td><input type="text"/></td><td>:</td><td><input type="text"/></td><td>:</td><td><input type="text"/></td><td>:</td><td><input type="text"/></td><td>:</td><td><input type="text"/></td><td>:</td><td><input type="text"/></td></tr> </table> <hr/> <p>Access Point Function:</p> <p> <input checked="" type="radio"/> Enable <input type="radio"/> Disable </p> <hr/> <p>Status:</p> <p><input type="checkbox"/> Send "Hello" message to peers.</p> <p style="text-align: center;">Link Status</p> <p><small>Note: The status is valid only when the peer also supports this function.</small></p> | <input type="checkbox"/> | <input type="text"/> | : | <input type="text"/> | : | <input type="text"/> | : | <input type="text"/> | : | <input type="text"/> | : | <input type="text"/> | <input type="checkbox"/> | <input type="text"/> | : | <input type="text"/> | : | <input type="text"/> | : | <input type="text"/> | : | <input type="text"/> | : | <input type="text"/> | <input type="checkbox"/> | <input type="text"/> | : | <input type="text"/> | : | <input type="text"/> | : | <input type="text"/> | : | <input type="text"/> | : | <input type="text"/> | <input type="checkbox"/> | <input type="text"/> | : | <input type="text"/> | : | <input type="text"/> | : | <input type="text"/> | : | <input type="text"/> | : | <input type="text"/> | <input type="checkbox"/> | <input type="text"/> | : | <input type="text"/> | : | <input type="text"/> | : | <input type="text"/> | : | <input type="text"/> | : | <input type="text"/> | <input type="checkbox"/> | <input type="text"/> | : | <input type="text"/> | : | <input type="text"/> | : | <input type="text"/> | : | <input type="text"/> | : | <input type="text"/> | <input type="checkbox"/> | <input type="text"/> | : | <input type="text"/> | : | <input type="text"/> | : | <input type="text"/> | : | <input type="text"/> | : | <input type="text"/> | <input type="checkbox"/> | <input type="text"/> | : | <input type="text"/> | : | <input type="text"/> | : | <input type="text"/> | : | <input type="text"/> | : | <input type="text"/> |
| <input type="checkbox"/> | <input type="text"/> | : | <input type="text"/> | : | <input type="text"/> | : | <input type="text"/> | : | <input type="text"/> | : | <input type="text"/> | | | | | | | | | | | | | | | | | | | | | | | | | | | | | | | | | | | | | | | | | | | | | | | | | | | | | | | | | | | | | | | | | | | | | | | | | | | | | | | | | | | | | | |
| <input type="checkbox"/> | <input type="text"/> | : | <input type="text"/> | : | <input type="text"/> | : | <input type="text"/> | : | <input type="text"/> | : | <input type="text"/> | | | | | | | | | | | | | | | | | | | | | | | | | | | | | | | | | | | | | | | | | | | | | | | | | | | | | | | | | | | | | | | | | | | | | | | | | | | | | | | | | | | | | | |
| <input type="checkbox"/> | <input type="text"/> | : | <input type="text"/> | : | <input type="text"/> | : | <input type="text"/> | : | <input type="text"/> | : | <input type="text"/> | | | | | | | | | | | | | | | | | | | | | | | | | | | | | | | | | | | | | | | | | | | | | | | | | | | | | | | | | | | | | | | | | | | | | | | | | | | | | | | | | | | | | | |
| <input type="checkbox"/> | <input type="text"/> | : | <input type="text"/> | : | <input type="text"/> | : | <input type="text"/> | : | <input type="text"/> | : | <input type="text"/> | | | | | | | | | | | | | | | | | | | | | | | | | | | | | | | | | | | | | | | | | | | | | | | | | | | | | | | | | | | | | | | | | | | | | | | | | | | | | | | | | | | | | | |
| <input type="checkbox"/> | <input type="text"/> | : | <input type="text"/> | : | <input type="text"/> | : | <input type="text"/> | : | <input type="text"/> | : | <input type="text"/> | | | | | | | | | | | | | | | | | | | | | | | | | | | | | | | | | | | | | | | | | | | | | | | | | | | | | | | | | | | | | | | | | | | | | | | | | | | | | | | | | | | | | | |
| <input type="checkbox"/> | <input type="text"/> | : | <input type="text"/> | : | <input type="text"/> | : | <input type="text"/> | : | <input type="text"/> | : | <input type="text"/> | | | | | | | | | | | | | | | | | | | | | | | | | | | | | | | | | | | | | | | | | | | | | | | | | | | | | | | | | | | | | | | | | | | | | | | | | | | | | | | | | | | | | | |
| <input type="checkbox"/> | <input type="text"/> | : | <input type="text"/> | : | <input type="text"/> | : | <input type="text"/> | : | <input type="text"/> | : | <input type="text"/> | | | | | | | | | | | | | | | | | | | | | | | | | | | | | | | | | | | | | | | | | | | | | | | | | | | | | | | | | | | | | | | | | | | | | | | | | | | | | | | | | | | | | | |
| <input type="checkbox"/> | <input type="text"/> | : | <input type="text"/> | : | <input type="text"/> | : | <input type="text"/> | : | <input type="text"/> | : | <input type="text"/> | | | | | | | | | | | | | | | | | | | | | | | | | | | | | | | | | | | | | | | | | | | | | | | | | | | | | | | | | | | | | | | | | | | | | | | | | | | | | | | | | | | | | | |

OK
Cancel

Available settings are explained as follows:

| Item | Description |
|-----------------------|-----------------------------------------------------------------------------------------------------------------------------------------------------------------------------------------------------------------------------------------------------------------------------------------------------------------------------------------------------------------------------------------------------------------------------------------------------------------------------------------------------------------------------------------------------|
| Mode | Choose the mode for WDS setting. Disable mode will not invoke any WDS setting. Bridge mode is designed to fulfill the first type of application. Repeater mode is for the second one. <div style="border: 1px solid #ccc; padding: 5px; margin-top: 10px;"> Disable <ul style="list-style-type: none"> <li style="background-color: #e0e0e0; padding: 2px;">Disable <li style="padding: 2px;">Bridge <li style="padding: 2px;">Repeater </div> |
| Security | There are three types for security, Disable , WEP and Pre-shared key . The setting you choose here will make the following WEP or Pre-shared key field valid or not. Choose one of the types for the router. |
| WEP | Check this box to use the same key set in Security Settings page. If you did not set any key in Security Settings page, this check box will be dimmed. |
| Pre-shared Key | Type – There are some types for you to choose. WPA and WPA2 are used for WDS devices (e.g.2920n wireless |

| | |
|------------------------------|----------------------------------------------------------------------------------------------------------------------------------------------------------------------------------------------------------------------------------------------------------------------------------------------------------------------------------------------------------------------------------|
| | <p>router, you can set the encryption mode as WPA or WPA2 to establish your WDS system between AP and the router.</p> <p>Key - Type 8 ~ 63 ASCII characters or 64 hexadecimal digits leading by "0x".</p> |
| Bridge | <p>If you choose Bridge as the connecting mode, please type in the peer MAC address in these fields. Four peer MAC addresses are allowed to be entered in this page at one time. Yet please disable the unused link to get better performance. If you want to invoke the peer MAC address, remember to check Enable box in the front of the MAC address after typing.</p> |
| Repeater | <p>If you choose Repeater as the connecting mode, please type in the peer MAC address in these fields. Four peer MAC addresses are allowed to be entered in this page at one time. Similarly, if you want to invoke the peer MAC address, remember to check Enable box in the front of the MAC address after typing.</p> |
| Access Point Function | <p>Click Enable to make this router serving as an access point; click Disable to cancel this function.</p> |
| Status | <p>It allows user to send "hello" message to peers. Yet, it is valid only when the peer also supports this function.</p> |

After finishing all the settings here, please click **OK** to save the configuration.

3.12.7 Advanced Setting

This page allows users to set advanced settings such as operation mode, channel bandwidth, guard interval, and aggregation MSDU for wireless data transmission.

Wireless LAN >> Advanced Setting

HT Physical Mode

| | |
|----------------------------|-------------------------------------------------------------------------------|
| Operation Mode | <input checked="" type="radio"/> Mixed Mode <input type="radio"/> Green Field |
| Channel Bandwidth | <input type="radio"/> 20 <input checked="" type="radio"/> 20/40 |
| Guard Interval | <input type="radio"/> long <input checked="" type="radio"/> auto |
| Aggregation MSDU(A-MSDU) | <input type="radio"/> Disable <input checked="" type="radio"/> Enable |
| Long Preamble | <input checked="" type="radio"/> Disable <input type="radio"/> Enable |
| Packet-OVERDRIVE™ TX Burst | <input checked="" type="radio"/> Disable <input type="radio"/> Enable |

OK

Available settings are explained as follows:

| Item | Description |
|--------------------------|---------------------------------------------------------------------------------------------------------------------------------------------------------------------------------------------------------------------------------------------------------------------------------------------------------------------------------------------------------------------------------------------------------------------------------------------------------------------------------------------------------------------------------|
| Operation Mode | <p>Mixed Mode – the router can transmit data with the ways supported in both 802.11a/b/g and 802.11n standards. However, the entire wireless transmission will be slowed down if 802.11g or 802.11b wireless client is connected.</p> <p>Green Field – to get the highest throughput, please choose such mode. Such mode can make the data transmission happening between 11n systems only. In addition, it does not have protection mechanism to avoid the conflict with neighboring devices of 802.11a/b/g.</p> |
| Channel Bandwidth | <p>20- the router will use 20Mhz for data transmission and receiving between the AP and the stations.</p> <p>20/40 – the router will use 20Mhz or 40Mhz for data transmission and receiving according to the station capability. Such channel can increase the performance for data transit.</p> |
| Guard Interval | It is to assure the safety of propagation delays and reflections for the sensitive digital data. If you choose auto as guard interval, the AP router will choose short guard interval (increasing the wireless performance) or long guard interval for data transmit based on the station capability. |
| Aggregation MSDU | Aggregation MSDU can combine frames with different sizes. It is used for improving MAC layer's performance for some brand's clients. The default setting is Enable . |
| Long Preamble | This option is to define the length of the sync field in an 802.11 packet. Most modern wireless network uses short preamble with 56 bit sync field instead of long preamble with 128 bit sync field. However, some original 11b wireless network devices only support long preamble. Click Enable to use Long Preamble if needed to communicate with this kind of devices. |
| Packet-OVERDRIVE | This feature can enhance the performance in data |

transmission about 40% * more (by checking **Tx Burst**). It is active only when both sides of Access Point and Station (in wireless client) invoke this function at the same time. That is, the wireless client must support this feature and invoke the function, too.

Note: Vigor N61 wireless adapter supports this function. Therefore, you can use and install it into your PC for matching with Packet-OVERDRIVE (refer to the following picture of Vigor N61 wireless utility window, choose **Enable** for **TxBURST** on the tab of **Option**).

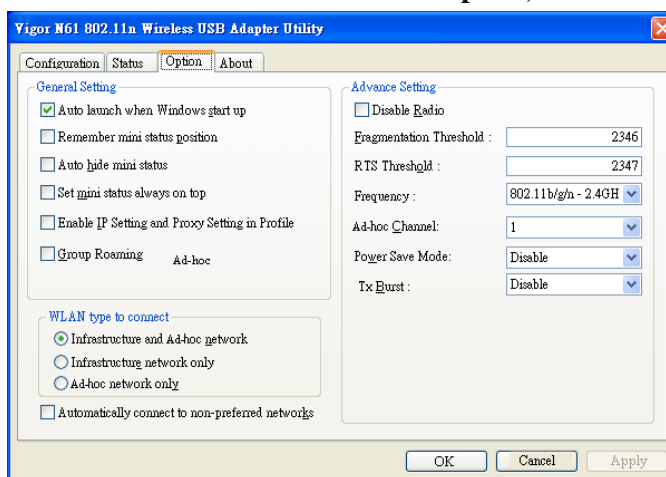

Note: * means the real transmission rate depends on the environment of the network.

After finishing all the settings here, please click **OK** to save the configuration.

3.12.8 WMM Configuration

WMM is an abbreviation of Wi-Fi Multimedia. It defines the priority levels for four access categories derived from 802.1d (prioritization tabs). The categories are designed with specific types of traffic, voice, video, best effort and low priority data. There are four accessing categories - AC_BE , AC_BK, AC_VI and AC_VO for WMM.

APSD (automatic power-save delivery) is an enhancement over the power-save mechanisms supported by Wi-Fi networks. It allows devices to take more time in sleeping state and consume less power to improve the performance by minimizing transmission latency.

Wireless LAN(2.4GHz) >> WMM Configuration

[Set to Factory Default](#)

WMM Configuration

WMM Capable Enable Disable

APSD Capable Enable Disable

WMM Parameters of Access Point

| | Aifsn | CWMin | CWMax | Txop | ACM | AckPolicy |
|-------|--------------------------------|--------------------------------|---------------------------------|---------------------------------|--------------------------|--------------------------|
| AC_BE | <input type="text" value="3"/> | <input type="text" value="4"/> | <input type="text" value="6"/> | <input type="text" value="0"/> | <input type="checkbox"/> | <input type="checkbox"/> |
| AC_BK | <input type="text" value="7"/> | <input type="text" value="4"/> | <input type="text" value="10"/> | <input type="text" value="0"/> | <input type="checkbox"/> | <input type="checkbox"/> |
| AC_VI | <input type="text" value="1"/> | <input type="text" value="3"/> | <input type="text" value="4"/> | <input type="text" value="94"/> | <input type="checkbox"/> | <input type="checkbox"/> |
| AC_VO | <input type="text" value="1"/> | <input type="text" value="2"/> | <input type="text" value="3"/> | <input type="text" value="47"/> | <input type="checkbox"/> | <input type="checkbox"/> |

WMM Parameters of Station

| | Aifsn | CWMin | CWMax | Txop | ACM |
|-------|--------------------------------|--------------------------------|---------------------------------|---------------------------------|--------------------------|
| AC_BE | <input type="text" value="3"/> | <input type="text" value="4"/> | <input type="text" value="10"/> | <input type="text" value="0"/> | <input type="checkbox"/> |
| AC_BK | <input type="text" value="7"/> | <input type="text" value="4"/> | <input type="text" value="10"/> | <input type="text" value="0"/> | <input type="checkbox"/> |
| AC_VI | <input type="text" value="2"/> | <input type="text" value="3"/> | <input type="text" value="4"/> | <input type="text" value="94"/> | <input type="checkbox"/> |
| AC_VO | <input type="text" value="2"/> | <input type="text" value="2"/> | <input type="text" value="3"/> | <input type="text" value="47"/> | <input type="checkbox"/> |

Available settings are explained as follows:

| Item | Description |
|---------------------|----------------------------------------------------------------------------------------------------------------------------------------------------------------------------------------------------------------------------------------------------------------------------------------------------------------------------------------------------------------------------------------------|
| WMM Capable | To apply WMM parameters for wireless data transmission, please click the Enable radio button. |
| APSD Capable | The default setting is Disable . |
| Aifsn | It controls how long the client waits for each data transmission. Please specify the value ranging from 1 to 15. Such parameter will influence the time delay for WMM accessing categories. For the service of voice or video image, please set small value for AC_VI and AC_VO categories For the service of e-mail or web browsing, please set large value for AC_BE and AC_BK categories. |
| CWMin/CWMax | CWMin means contention Window-Min and CWMax means contention Window-Max. Please specify the value ranging from 1 to 15. Be aware that CWMax value must be greater than CWMin or equals to CWMin value. Both values will influence the time delay for WMM accessing categories. The difference between AC_VI and AC_VO categories must be smaller; however, the difference |

| | |
|------------------|--------------------------------------------------------------------------------------------------------------------------------------------------------------------------------------------------------------------------------------------------------------------------------------------------------------------------------------------------------------------------------|
| | between AC_BE and AC_BK categories must be greater. |
| Txop | It means transmission opportunity. For WMM categories of AC_VI and AC_VO that need higher priorities in data transmission, please set greater value for them to get highest transmission opportunity. Specify the value ranging from 0 to 65535. |
| ACM | It is an abbreviation of Admission control Mandatory. It can restrict stations from using specific category class if it is checked. Note: Vigor2760 provides standard WMM configuration in the web page. If you want to modify the parameters, please refer to the Wi-Fi WMM standard specification. |
| AckPolicy | “Uncheck” (default value) the box means the AP router will answer the response request while transmitting WMM packets through wireless connection. It can assure that the peer must receive the WMM packets. “Check” the box means the AP router will not answer any response request for the transmitting packets. It will have better performance with lower reliability. |

After finishing all the settings here, please click **OK** to save the configuration.

3.12.9 AP Discovery

Vigor router can scan all regulatory channels and find working APs in the neighborhood. Based on the scanning result, users will know which channel is clean for usage. Also, it can be used to facilitate finding an AP for a WDS link. Notice that during the scanning process (about 5 seconds), no client is allowed to connect to Vigor.

This page is used to scan the existence of the APs on the wireless LAN. Yet, only the AP which is in the same channel of this router can be found. Please click **Scan** to discover all the connected APs.

Wireless LAN >> Access Point Discovery

Access Point List

| BSSID | Channel | SSID |
|-------|---------|------|
| | | |

See [Statistics](#).

Note: During the scanning process (~5 seconds), no station is allowed to connect with the router.

Add to [WDS Settings](#) :

AP's MAC address : : : : :

 Bridge Repeater

Available settings are explained as follows:

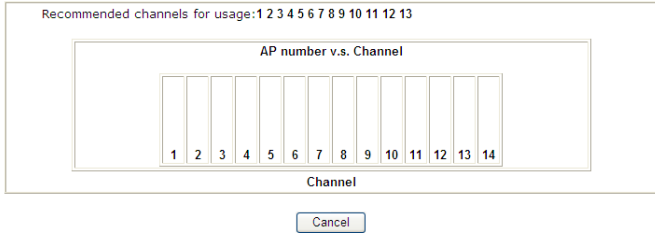
| Item | Description |
|-------------------|------------------------------------------------------------------------------------------------------------------------------------------------------------------------------------------------------------------------------------------------------------------------------|
| Scan | It is used to discover all the connected AP. The results will be shown on the box above this button. |
| Statistics | It displays the statistics for the channels used by APs. Wireless LAN >> Site Survey Statistics  |
| Add to | If you want the found AP applying the WDS settings, please type in the AP's MAC address on the bottom of the page and click Bridge or Repeater. Next, click Add to . Later, the MAC address of the AP will be added to Bridge or Repeater field of WDS settings page. |

3.12.10 Station List

Station List provides the knowledge of connecting wireless clients now along with its status code. There is a code summary below for explanation. For convenient **Access Control**, you can select a WLAN station and click **Add to Access Control** below.

Wireless LAN(2.4GHz) >> Station List

Station List

| Status | MAC Address | Associated with |
|--------|-------------|-----------------|
| | | |

Status Codes :
 C: Connected, No encryption.
 E: Connected, WEP.
 P: Connected, WPA.
 A: Connected, WPA2.
 B: Blocked by Access Control.
 N: Connecting.
 F: Fail to pass WPA/PSK authentication.

Note: After a station connects to the router successfully, it may be turned off without notice. In that case, it will still be on the list until the connection expires.

Add to Access Control :

Client's MAC address : : : : :

Available settings are explained as follows:

| Item | Description |
|----------------|---------------------------------------------------------------------------------|
| Refresh | Click this button to refresh the status of station list. |
| Add | Click this button to add current typed MAC address into Access Control . |

3.13 USB Application

USB storage disk connected on Vigor router can be regarded as a server or WAN interface. By way of Vigor router, clients on LAN can access, write and read data stored in USB storage disk with different applications. After setting the configuration in **USB Application**, you can type the IP address of the Vigor router and username/password created in **USB Application**>>**USB User Management** on the client software. Then, the client can use the FTP site (USB storage disk) as a simple local or remote NAS device.

Note: USB ports on Vigor router are allowed to connect to compatible USB 3G/4G modems. For network connection via USB modem, refer to **WAN**>>**Internet Access** and **WAN**>>**General Setup** for detailed information.

Wireless LAN
USB Application
USB General Settings
USB User Management
File Explorer
USB Device Status
Modem Support List

3.13.1 USB General Settings

This page will determine the number of concurrent FTP connection, default charset for FTP server. At present, the Vigor router can support USB storage disk with FAT32 format only so your USB memory should be formatted to FAT32.

USB Application >> USB General Settings

USB General Settings

General Settings

Simultaneous FTP Connections (Maximum 6)
Default Charset

Note: 1. If Charset is set to "English", only English long file name is supported.
2. Multi-session ftp download will be banned by Router FTP server. If your ftp client have multi-connection mechanism, such as FileZilla, you may limit client connections setting to 1 to get better performance.

OK

Available settings are explained as follows:

| Item | Description |
|------------------|--------------------------------------------------------------------------------------------------------------------------------------------------------------------------------------------------------------------------------------------------------------------------------------------------------------------------------------|
| General Settings | Simultaneous FTP Connections - This field is used to specify the quantity of the FTP sessions. The router allows up to 6 FTP sessions connecting to USB storage disk at one time. Default Charset - At present, Vigor router supports four types of character sets. Default Charset is for English based file name. |



After finishing all the settings here, please click **OK** to save the configuration.

3.13.2 USB User Management

This page allows you to set profiles for FTP/Samba users. Any user who wants to access into the USB storage disk must type the same username and password configured in this page. Before adding or modifying settings in this page, please insert a USB storage disk first. Otherwise, an error message will appear to warn you.

USB Application >> USB User Management

| USB User Management Set to Factory Default | | | | | |
|--------------------------------------------------------------|----------|-------------|---------------------|----------|-------------|
| Index | Username | Home Folder | Index | Username | Home Folder |
| 1. | | | 9. | | |
| 2. | | | 10. | | |
| 3. | | | 11. | | |
| 4. | | | 12. | | |
| 5. | | | 13. | | |
| 6. | | | 14. | | |
| 7. | | | 15. | | |
| 8. | | | 16. | | |

Click index number to access into configuration page.

USB Application >> USB User Management

Profile Index: 1

FTP/Samba User Enable Disable

Username

Password (Maximum 11 Characters)

Confirm Password

Home Folder

Access Rule

File Read Write Delete

Directory List Create Remove

Note: The folder name can only contain the following characters: A-Z a-z 0-9 \$ % ' - _ @ ~ ` ! () / and space.

Available settings are explained as follows:

| Item | Description |
|-----------------|-----------------------------------------------------------------------------------------------------------------------------------------------------------------------------------------------------------------------------------------------|
| FTP User | <p>Enable – Click this button to activate this profile (account) for FTP. Later, the user can use the username specified in this page to login into FTP server.</p> <p>Disable – Click this button to disable such profile.</p> |

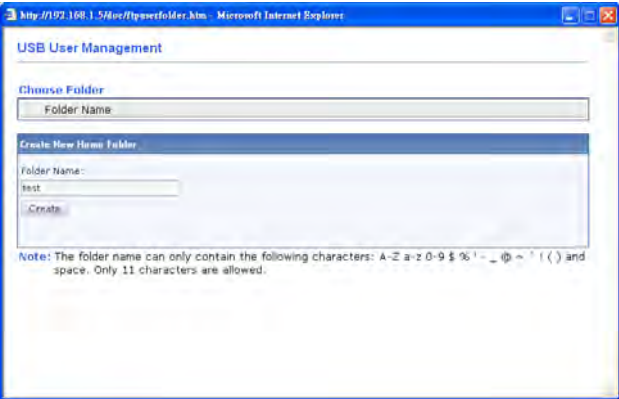
| | |
|-------------------------|-------------------------------------------------------------------------------------------------------------------------------------------------------------------------------------------------------------------------------------------------------------------------------------------------------------------------------------------------------------------------------------------------------------------------------------------------------------------------------------------------------------------------------------------------------------------------------------------------------------------------------------------------------------------------------------------------------------------------------------------------------------------------------------------------------------------------|
| Username | <p>Type the username for FTP/Samba users for accessing into FTP server (USB storage disk). Be aware that users cannot access into USB storage disk in anonymity. Later, you can open FTP client software and type the username specified here for accessing into USB storage disk. The length of the name is limited to 11 characters.</p> <p>Note: You cannot have a username of 'admin' as it is reserved.</p> <p>Note: FTP Passive mode is not supported by Vigor Router. Please disable the mode on the FTP client.</p> |
| Password | <p>Type the password for FTP/Samba users for accessing FTP server. Later, you can open FTP client software and type the password specified here for accessing into USB storage disk. The length of the password is limited to 11 characters.</p> |
| Confirm Password | <p>Type the password again to make confirmation.</p> |
| Home Folder | <p>It determines the folder for the client to access into. The user can enter a directory name in this field. Then, after clicking OK, the router will create the specific/new folder in the USB storage disk. In addition, if the user types “/” here, he/she can access into all of the disk folders and files in USB storage disk.</p> <p>Note: When write protect status for the USB storage disk is ON, you cannot type any new folder name in this field. Only “/” can be used in such case.</p> <p>You can click  to open the following dialog to add any new folder which can be specified as the Home Folder.</p>  |
| Access Rule | <p>It determines the authority for such profile. Any user, who uses such profile for accessing into USB storage disk, must follow the rule specified here.</p> <p>File – Check the items (Read, Write and Delete) for such profile.</p> <p>Directory –Check the items (List, Create and Remove) for such profile.</p> |

Before you click **OK**, you have to insert a USB storage disk into the USB interface of the Vigor router. Otherwise, you cannot save the configuration.

3.13.3 File Explorer

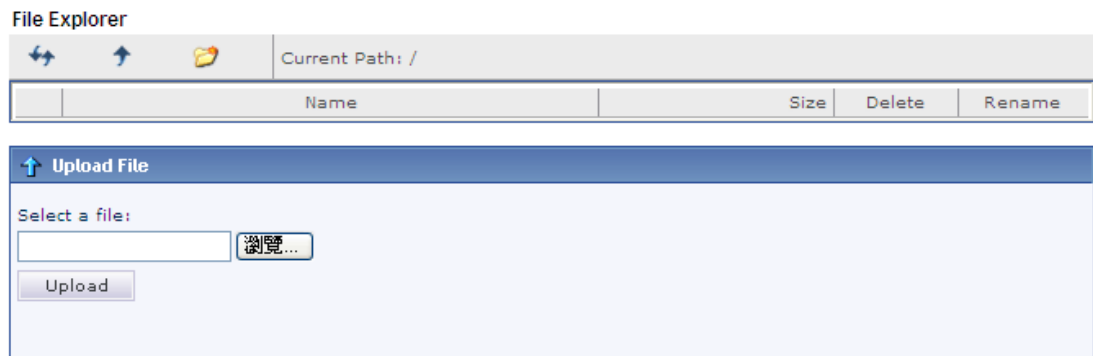

File Explorer offers an easy way for users to view and manage the content of USB storage disk connected on Vigor router.

USB Application >> File Explorer



Note: The folder can not be deleted when it is not empty.

Available settings are explained as follows:

| Item | Description |
|---------------------------------------------------------------------------------------------------|--------------------------------------------------------------------------------------------------------------------------------------------------------|
|  Refresh | Click this icon to refresh files list. |
|  Back | Click this icon to return to the upper directory. |
|  Create | Click this icon to add a new folder. |
| Current Path | Display current folder. |
| Upload | Click this button to upload the selected file to the USB storage disk. The uploaded file in the USB diskette can be shared for other user through FTP. |

3.13.4 USB Device Status

This page is to monitor the status for the users who accessing into FTP or Samba server (USB storage disk) via the Vigor router. In addition, the status of the USB modem or USB printer connecting to Vigor router can be checked from such page. If you want to remove the storage disk from USB port in router, please click **Disconnect USB Disk** first. And then, remove the USB storage disk later.

USB Application >> USB Device Status

Disk
Modem
Printer
| [Refresh](#) |

USB Mass Storage Device Status

Connection Status: No Disk Connected Disconnect USB Disk

Disk Capacity: 0 MB

Free Capacity: 0 MB [Refresh](#)

USB Disk Users Connected

| Index | Service | IP Address(Port) | Username |
|-------|---------|------------------|----------|
| | | | |
| | | | |

Note: If the write protect switch of USB disk is turned on, the USB disk is in **READ-ONLY** mode. No data can be written to it.

Available settings are explained as follows:

| Item | Description |
|--------------------------|---------------------------------------------------------------------------------------------------------------------------|
| Connection Status | If there is no USB storage disk connected to Vigor router, “ No Disk Connected ” will be shown here. |
| Disk Capacity | It displays the total capacity of the USB storage disk. |
| Free Capacity | It displays the free space of the USB storage disk. Click Refresh at any time to get new status for free capacity. |
| Index | It displays the number of the client which connecting to FTP server. |
| IP Address | It displays the IP address of the user’s host which connecting to the FTP server. |
| Username | It displays the username that user uses to login to the FTP server. |

When you insert USB storage disk into the Vigor router, the system will start to find out such device within several seconds.

USB Application >> USB Device Status

Disk
Modem
Printer
| [Refresh](#) |

USB Mass Storage Device Status

Connection Status: Disk Connected Disconnect USB Disk

Write Protect Status: No

Disk Capacity: 2009 MB

Free Capacity: 925 MB [Refresh](#)

USB Disk Users Connected

| Index | Service | IP Address(Port) | Username |
|-------|---------|------------------|----------|
| | | | |
| | | | |

Note: If the write protect switch of USB disk is turned on, the USB disk is in **READ-ONLY** mode. No data can be written to it.

3.13.5 Modem Support List

For the latest list of supported USB 3G/4G modems, particularly with regional telcos, we recommend checking the web site, but this page will show a summary of some of the supported models.

USB Application >> Modem Support List

The following compatibility test lists 3.5G/LTE modems supported by Vigor router under certain environment or countries. If the LTE modem you have is on the list but cannot work properly, please write an e-mail to support@draytek.com or consult your dealer for further information.

| 3.5G | LTE | WiMAX |
|-----------|------------------|--------|
| Brand | Module | Status |
| 4G system | XSPUG P3 | C |
| Aiko | Aiko 76E | Y |
| Aiko | Aiko 83D | Y |
| Alcatel | X080S | M |
| Alcatel | X230 | M |
| Alcatel | X500 | C |
| Alfa | Fly3G | Y |
| Amoi | Amoi H01 | Y |
| AnyDATA | ADU-300 | Y |
| AnyDATA | ADU-500A | Y |
| AnyDATA | ADU-510A | M |
| ASUS | ASUS T500 | M |
| BandRich | Bandlux C100 | M |
| BandRich | Bandlux C100S[1] | M |
| BandRich | Bandlux C170 | M |
| BandRich | Bandlux C270 | Y |

3.14 System Maintenance

For the system setup, there are several items that you have to know the way of configuration: System Status, TR-069, Administrator Password, User Password, Login Page Greeting, Configuration Backup, Syslog /Mail Alert, Time and Date, Management, Reboot System, Firmware Upgrade and Activation.

Below shows the menu items for System Maintenance.

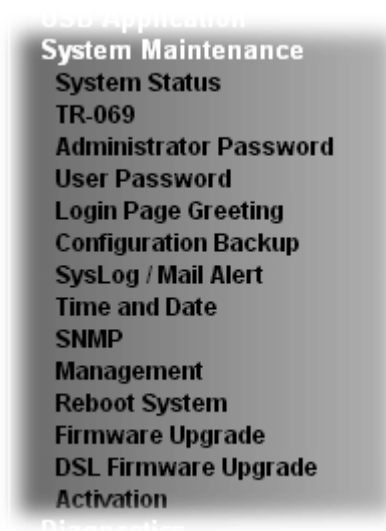

3.14.1 System Status

The **System Status** provides basic network settings of Vigor router. It includes LAN and WAN interface information. Also, you could get the current running firmware version or firmware related information from this presentation.

System Status

Model Name : Vigor2760Vn
Firmware Version : 3.7.5.1
Build Date/Time : Mar 31 2014 10:02:56

| LAN | | | | | |
|------------------|-------------------|-------------|---------------|-------------|---------|
| | MAC Address | IP Address | Subnet Mask | DHCP Server | DNS |
| LAN1 | 00-1D-AA-B8-15-00 | 192.168.1.1 | 255.255.255.0 | ON | 8.8.8.8 |
| LAN2 | 00-1D-AA-B8-15-00 | 192.168.2.1 | 255.255.255.0 | ON | 8.8.8.8 |
| IP Routed Subnet | 00-1D-AA-B8-15-00 | 192.168.0.1 | 255.255.255.0 | ON | 8.8.8.8 |

| Wireless LAN | | | |
|-------------------|------------------|------------------|---------|
| MAC Address | Frequency Domain | Firmware Version | SSID |
| 00-1D-AA-B8-15-00 | Europe | 2.7.1.5 | DrayTek |

| WAN | | | | | |
|------|--------------|-------------------|------------|------------|-----------------|
| | Link Status | MAC Address | Connection | IP Address | Default Gateway |
| WAN1 | Disconnected | 00-1D-AA-B8-15-01 | PPPoE | --- | --- |
| WAN2 | Disconnected | 00-1D-AA-B8-15-02 | --- | --- | --- |
| WAN3 | Disconnected | 00-1D-AA-B8-15-03 | --- | --- | --- |

| IPv6 | | | |
|------|-----------------------------|-------|----------------------|
| | Address | Scope | Internet Access Mode |
| LAN | FE80::21D:AAFF:FE88:1500/64 | Link | --- |

| VoIP | | | |
|--------|---------|------|--------|
| Port | Profile | Reg. | In/Out |
| Phone1 | | No | 0/0 |
| Phone2 | | No | 0/0 |

User Mode is OFF now.

Available settings are explained as follows:

| Item | Description |
|-------------------------|----------------------------------------------------------------------------------------------------------------------------------------------------------------------------------------------------------------------------------------------------------------------------------------------------------------------------------------------------------------------------------------------------------------------------|
| Model Name | Display the model name of the router. |
| Firmware Version | Display the firmware version of the router. |
| Build Date/Time | Display the date and time of the current firmware build. |
| LAN | <p>MAC Address - Display the MAC address of the LAN Interface.</p> <p>IP Address - Display the IP address of the LAN interface.</p> <p>Subnet Mask - Display the subnet mask address of the LAN interface.</p> <p>DHCP Server - Display the current status of DHCP server of the LAN interface</p> <p>DNS - Display the assigned IP address of the primary DNS.</p> |
| WAN | <p>Link Status - Display current connection status.</p> <p>MAC Address - Display the MAC address of the WAN Interface.</p> <p>Connection - Display the connection type.</p> <p>IP Address - Display the IP address of the WAN interface.</p> <p>Default Gateway - Display the assigned IP address of the default gateway.</p> |
| IPv6 | <p>Address - Display the IPv6 address for LAN.</p> <p>Scope - Display the scope of IPv6 address. For example, IPv6 Link Local could only be used for direct IPv6 link. It can't be used for IPv6 internet.</p> <p>Internet Access Mode – Display the connection mode chosen for accessing into Internet.</p> |

3.14.2 TR-069

This device supports TR-069 standard. It is very convenient for an administrator to manage a TR-069 device through an Auto Configuration Server, e.g., VigorACS.

System Maintenance >> TR-069 Setting

ACS and CPE Settings

| | |
|-----------------------------------------------------------------------|-------------------------------------------|
| ACS Server On | Internet <input type="button" value="v"/> |
| ACS Server | |
| URL | <input type="text"/> |
| Username | <input type="text"/> |
| Password | <input type="text"/> |
| <input type="button" value="Test With Inform"/> Event Code | |
| | PERIODIC <input type="button" value="v"/> |
| Last Inform Response Time | :(NA) ● |
| CPE Client | |
| <input type="radio"/> Enable <input checked="" type="radio"/> Disable | |
| URL | <input type="text"/> |
| Port | 8069 <input type="text"/> |
| Username | vigor <input type="text"/> |
| Password | ***** <input type="text"/> |

Periodic Inform Settings

| | |
|------------------------------------------|------------------------------------|
| <input checked="" type="radio"/> Disable | |
| <input type="radio"/> Enable | |
| Interval Time | 900 <input type="text"/> second(s) |

STUN Settings

| | |
|------------------------------------------|-----------------------------------|
| <input checked="" type="radio"/> Disable | |
| <input type="radio"/> Enable | |
| Server Address | <input type="text"/> |
| Server Port | 3478 <input type="text"/> |
| Minimum Keep Alive Period | 60 <input type="text"/> second(s) |
| Maximum Keep Alive Period | -1 <input type="text"/> second(s) |

Available settings are explained as follows:

| Item | Description |
|----------------------|-------------------------------------------------------------------------------------------------------------------------------------------------------------------------------------------------------------|
| ACS Server On | Choose the interface for the router connecting to ACS server. |
| ACS Server | URL/Username/Password – Such data must be typed according to the ACS (Auto Configuration Server) you want to link. Please refer to Auto Configuration Server user's manual for detailed information. |
| CPE Client | Such information is useful for Auto Configuration Server. |

| | |
|---------------------------------|----------------------------------------------------------------------------------------------------------------------------------------------------------------------------------------------------------------------------------------------------------------------------------------------------------------------------------------------------------------------------------------------------------------------------------------------------------------------------------------------------------------------------------------------------------------------------------------------------------------------------------------------------------------------------------------------------------------------------------------------------------------------------------------------------------|
| | <p>Enable/Disable – Allow/Deny the CPE Client to connect with Auto Configuration Server.</p> <p>Port – Sometimes, port conflict might be occurred. To solve such problem, you might change port number for CPE.</p> |
| Periodic Inform Settings | The default setting is Enable . Please set interval time or schedule time for the router to send notification to CPE. Or click Disable to close the mechanism of notification. |
| STUN Settings | <p>The default is Disable. If you click Enable, please type the relational settings listed below:</p> <p>Server IP – Type the IP address of the STUN server.</p> <p>Server Port – Type the port number of the STUN server.</p> <p>Minimum Keep Alive Period – If STUN is enabled, the CPE must send binding request to the server for the purpose of maintaining the binding in the Gateway. Please type a number as the minimum period. The default setting is “60 seconds”.</p> <p>Maximum Keep Alive Period – If STUN is enabled, the CPE must send binding request to the server for the purpose of maintaining the binding in the Gateway. Please type a number as the maximum period. A value of “-1” indicates that no maximum period is specified.</p> |

3.14.3 Administrator Password

This page allows you to set new password.

System Maintenance >> Administrator Password Setup

Administrator Password

| | | |
|------------------|----------------------|------------------------------|
| Old Password | <input type="text"/> | |
| New Password | <input type="text"/> | (Max. 23 characters allowed) |
| Confirm Password | <input type="text"/> | (Max. 23 characters allowed) |

Note: Password can contain only a-z A-Z 0-9 , ; : . " < > * + = \ | ? @ # ^ ! ()

OK

Available settings are explained as follows:

| Item | Description |
|-------------------------|-----------------------------------------------------------------------------------------|
| Old Password | Type in the old password. The factory default setting for password is “ admin ”. |
| New Password | Type in new password in this field. |
| Confirm Password | Type in the new password again. |

When you click **OK**, the login window will appear. Please use the new password to access into the web user interface again.

3.14.4 User Password

This page allows you to set new password for user operation.

System Maintenance >> User Password

Enable User Mode for simple web configuration

User Password | [Set to Factory Default](#) |

| | |
|------------------|----------------------|
| Password | <input type="text"/> |
| Confirm Password | <input type="text"/> |

Note: 1.Password can contain only a-z A-Z 0-9 , ; : . " < > * + = \ | ? @ # ^ ! ()
 2.Password can't be only *.Example:'*' or '***' or '*****' is illegal, but '123*' or '*45' is OK.

Available settings are explained as follows:

| Item | Description |
|------------------------------------------------------|------------------------------------------------------------------------------------------------------------------------------------------------------------------------------------------------------------------------------------------------------------------------------|
| Enable User Mode for simple web configuration | After checking this box, you can access into the web user interface with the password typed here for simple web configuration. The settings on simple web user interface will be different with full web user interface accessed by using the administrator password. |
| Password | Type in new password in this field. The length of the password is limited to 31 characters. |
| Confirm Password | Type in the new password again. |
| Set to Factory Default | Click to return to the factory default setting. |

When you click **OK**, the login window will appear. Please use the new password to access into the web user interface again.

Below shows an example for accessing into User Operation with User Password.

1. Open **System Maintenance>>User Password**.
2. Check the box of **Enable User Mode for simple web configuration** to enable user mode operation. Type a new password in the field of New Password and click **OK**.

System Maintenance >> User Password

Enable User Mode for simple web configuration

User Password | [Set to Factory Default](#) |

| | |
|------------------|--------------------------|
| Password | <input type="password"/> |
| Confirm Password | <input type="password"/> |

Note: 1.Password can contain only a-z A-Z 0-9 , ; : . " < > * + = \ | ? @ # ^ ! ()
 2.Password can't be only *.Example:'*' or '***' or '*****' is illegal, but '123*' or '*45' is OK.

3. The following screen will appear. Simply click **OK**.

System Maintenance >> User Password

Active Configuration

| |
|------------------|
| Password : ***** |
|------------------|

4. Log out Vigor router web user interface by clicking the Logout button.



5. The following window will be open to ask for username and password. Type the new user password in the field of **Password** and click **Login**.



DrayTek **Vigor2760 Series**

Login

Username

Password

Login

Copyright © 2013 DrayTek Corp. All Rights Reserved.

6. The main screen with User Mode will be shown as follows.

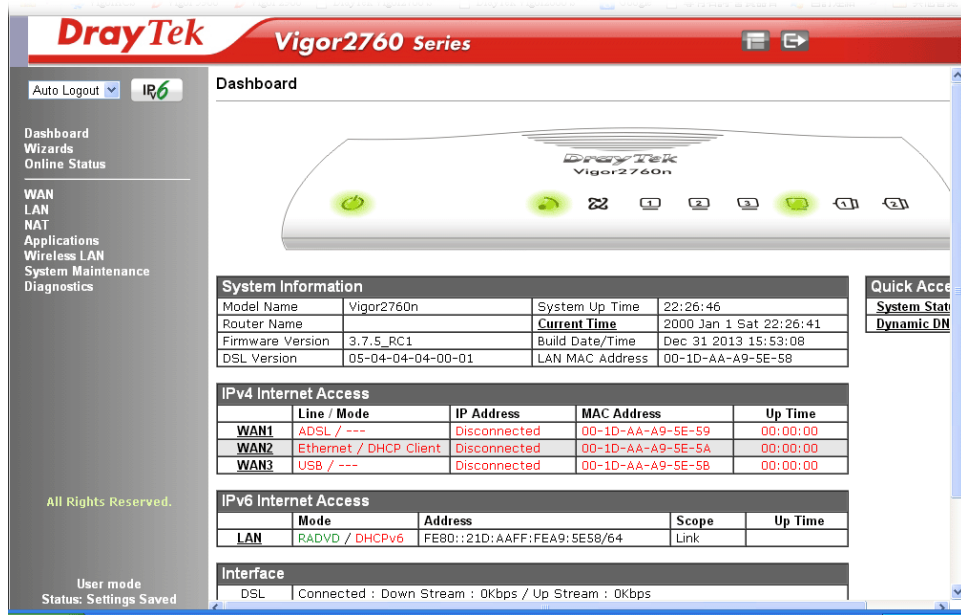

Settings to be configured in User Mode will be less than settings in Admin Mode. Only basic configuration settings will be available in User Mode.

Note: Setting in User Mode can be configured as same as in Admin Mode.

3.14.5 Login Page Greeting

When you want to access into the web user interface of Vigor router, the system will ask you to offer username and password first. At that moment, the background of the web page is blank and no heading will be displayed on the Login window. This page allows you to specify login URL and the heading on the Login window if you have such requirement.

System Maintenance >> Login Page Greeting

Login Page Greeting

Enable

Login Page Title (31 char max.)

Welcome Message and Bulletin (Max 511 characters) [Preview](#) | [Set to Factory Default](#) |

```
<h1><b><font color=red>Welcome Message</font></b></h1><p>This welcome message is displayed in the Login page of the router. Replace this text with your own message. </p><ol><li>The welcome message can be written in HTML so lists such as this one can be created </li><li>Other markup tags such as p, font or img can be used</li></ol>
```

Examples of Welcome Message and Bulletin:

```
<h1><b><font color=red>Welcome Message</font></b></h1>
<p>Message</p>
```

OK Cancel

Available settings are explained as follows:

| Item | Description |
|-------------------------------------|-----------------------------------------------------------------------------------------------------------------------------------------------------------------------------------------------|
| Enable | Check this box to enable the login customization function. |
| Login Page Title | Type a brief description (e.g., Welcome to DrayTek) which will be shown on the heading of the login dialog. |
| Welcome Message and Bulletin | Type words or sentences here. It will be displayed for bulletin message. In addition, it can be displayed on the login dialog at the bottom. Note that do not type URL redirect link here. |
| Preview | Click it to display the preview of the login window based on the settings on this web page. |
| Set to Factory Default | Click to return to the factory default setting. |

Below shows an example of login customization with the information typed in Login Description and Bulletin.

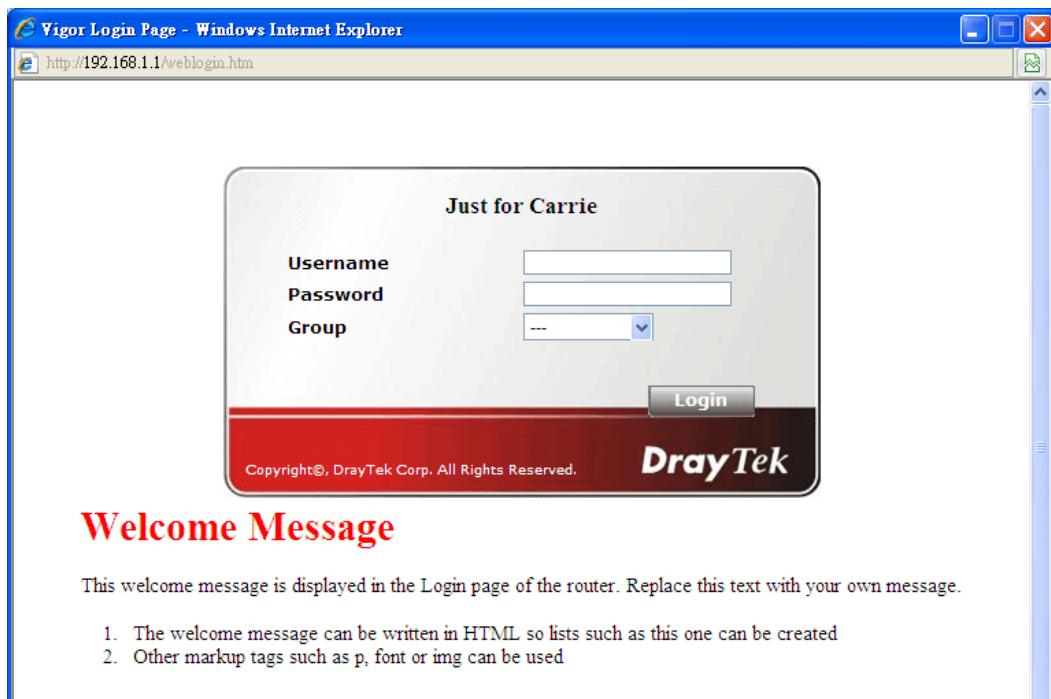

3.14.6 Configuration Backup

Backup the Configuration

Follow the steps below to backup your configuration.

1. Go to **System Maintenance >> Configuration Backup**. The following windows will be popped-up, as shown below.

System Maintenance >> Configuration Backup

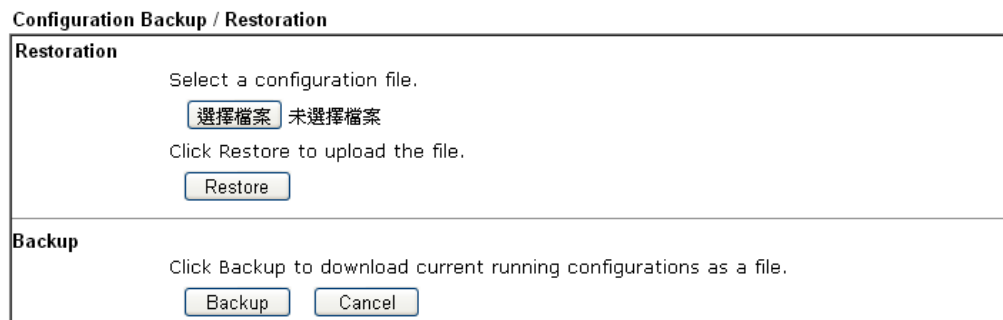

2. Click **Backup** button to get into the following dialog. Click **Save** button to open another dialog for saving configuration as a file.

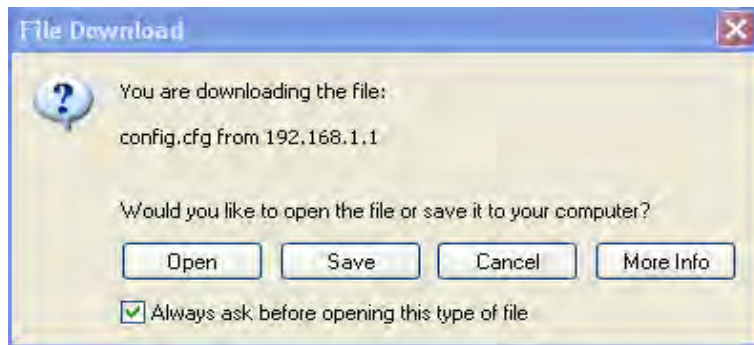

3. In **Save As** dialog, the default filename is **config.cfg**. You could give it another name by yourself.

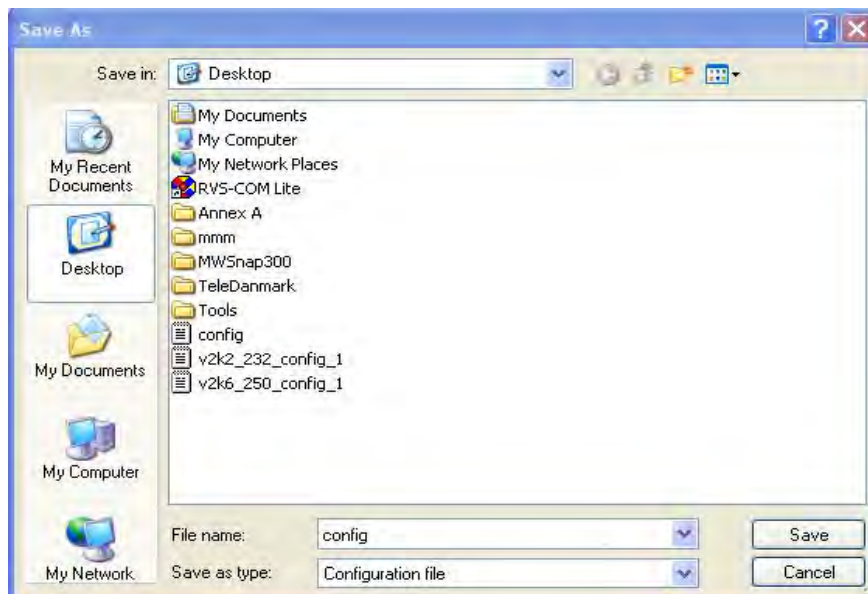

4. Click **Save** button, the configuration will download automatically to your computer as a file named **config.cfg**.

The above example is using **Windows** platform for demonstrating examples. The **Mac** or **Linux** platform will appear different windows, but the backup function is still available.

Note: Backup for Certification must be done independently. The Configuration Backup does not include information of Certificate.

Restore Configuration

1. Go to **System Maintenance >> Configuration Backup**. The following windows will be popped-up, as shown below.

System Maintenance >> Configuration Backup

Configuration Backup / Restoration

| |
|--------------------------------------------------------------------------------------------------------------------------------------------------------------------------------|
| Restoration Select a configuration file. <input type="button" value="選擇檔案"/> 未選擇檔案 Click Restore to upload the file. <input type="button" value="Restore"/> |
| Backup Click Backup to download current running configurations as a file. <input type="button" value="Backup"/> <input type="button" value="Cancel"/> |

2. Click **Browse** button to choose the correct configuration file for uploading to the router.
3. Click **Restore** button and wait for few seconds, the following picture will tell you that the restoration procedure is successful.

3.14.7 Syslog/Mail Alert

SysLog function is provided for users to monitor router. There is no bother to directly get into the Web user interface of the router or borrow debug equipments.

System Maintenance >> SysLog / Mail Alert Setup

SysLog / Mail Alert Setup

| | |
|------------------------------------------------------------------------------------------------------------------------------------------------------------------------------------------------------------------------------------------------------------------------------------------------------------------------------------------------------------------------------------------------------------------------------------------------------------------------------------------------------------------------------------------------------------------------------------------------------------------------------------------------------------------------------------------------------------------------------------------------------------------------------------------------------------------------------------------------------------------|----------------------------------------------------------------------------------------------------------------------------------------------------------------------------------------------------------------------------------------------------------------------------------------------------------------------------------------------------------------------------------------------------------------------------------------------------------------------------------------------------------------------------------------------------------------------------------------------------------------------------------------------------------------------------------------------------------------------------------------------------------------------------------------------|
| <p>SysLog Access Setup</p> <p><input checked="" type="checkbox"/> Enable</p> <p>Syslog Save to:</p> <p><input checked="" type="checkbox"/> Syslog Server</p> <p><input type="checkbox"/> USB Disk</p> <p>Router Name <input style="width: 100%;" type="text"/></p> <p>Server IP Address <input style="width: 100%;" type="text"/></p> <p>Destination Port <input style="width: 50%;" type="text" value="514"/></p> <p>Mail Syslog <input type="checkbox"/> Enable</p> <p>Enable syslog message:</p> <p><input checked="" type="checkbox"/> Firewall Log</p> <p><input checked="" type="checkbox"/> VPN Log</p> <p><input checked="" type="checkbox"/> User Access Log</p> <p><input checked="" type="checkbox"/> Call Log</p> <p><input checked="" type="checkbox"/> WAN Log</p> <p><input checked="" type="checkbox"/> Router/DSL information</p> | <p>Mail Alert Setup</p> <p><input checked="" type="checkbox"/> Enable <input type="button" value="Send a test e-mail"/></p> <p>SMTP Server <input style="width: 100%;" type="text"/></p> <p>SMTP Port <input style="width: 50%;" type="text" value="25"/></p> <p>Mail To <input style="width: 100%;" type="text"/></p> <p>Return-Path <input style="width: 100%;" type="text"/></p> <p><input type="checkbox"/> Use SSL</p> <p><input type="checkbox"/> Authentication</p> <p>Username <input style="width: 100%;" type="text"/></p> <p>Password <input style="width: 100%;" type="text"/></p> <p>Enable E-Mail Alert:</p> <p><input checked="" type="checkbox"/> DoS Attack</p> <p><input checked="" type="checkbox"/> IM-P2P</p> <p><input checked="" type="checkbox"/> VPN LOG</p> |
|------------------------------------------------------------------------------------------------------------------------------------------------------------------------------------------------------------------------------------------------------------------------------------------------------------------------------------------------------------------------------------------------------------------------------------------------------------------------------------------------------------------------------------------------------------------------------------------------------------------------------------------------------------------------------------------------------------------------------------------------------------------------------------------------------------------------------------------------------------------|----------------------------------------------------------------------------------------------------------------------------------------------------------------------------------------------------------------------------------------------------------------------------------------------------------------------------------------------------------------------------------------------------------------------------------------------------------------------------------------------------------------------------------------------------------------------------------------------------------------------------------------------------------------------------------------------------------------------------------------------------------------------------------------------|

- Note:** 1. Mail Syslog cannot be activated unless USB Disk is ticked for "Syslog Save to".
 2. Mail Syslog feature sends a Syslog file when its size reaches 1M Bytes.
 3. We only support secured SMTP connection on port 465.

Available settings are explained as follows:

| Item | Description |
|----------------------------|-------------------------------------------------------------------------------------------------------------------------------------------------------------------------------------------------------------------------------------------------------------------------------------------------------------------------------------------------------------------------------------------------------------------------------------------------------------------------------------------------------------------------------------------------------------------------------------------------------------------------------------------------------------------|
| SysLog Access Setup | <p>Enable - Check Enable to activate function of syslog.</p> <p>Syslog Save to – Check Syslog Server to save the log to Syslog server.</p> <p>Check USB Disk to save the log to the attached USB storage disk.</p> |
| Router Name | <p>Display the name for such router configured in System Maintenance>>Management.</p> <p>If there is no name here, simply lick the link to access into System Maintenance>>Management to set the router name.</p> <p>Server IP Address -The IP address of the Syslog server.</p> <p>Destination Port - Assign a port for the Syslog protocol.</p> <p>Mail Syslog – Check the box to recode the mail event on Syslog.</p> <p>Enable syslog message - Check the box listed on this web page to send the corresponding message of firewall, VPN, User Access, Call, WAN, Router/DSL information to Syslog.</p> |

| | |
|--------------------------------|----------------------------------------------------------------------------------------------------------------------------------------------------------------------------------------------------------------------------------------------------------------------------------------------------------------------------------------------------------------------------------------------------------------------------------------------------------------------------------------------------------------------------------------------------------------------------------------------------------------------------------------------------------------------------------------------------------------------------------------------------------------------------------------------------------------------------------------------------------------------------------------------------------------------------------------------------------------------------------------------------------------------------------------------------------------------------|
| <p>Mail Alert Setup</p> | <p>Check Enable to activate function of mail alert.</p> <p>Send a test e-mail - Make a simple test for the e-mail address specified in this page. Please assign the mail address first and click this button to execute a test for verify the mail address is available or not.</p> <p>SMTP Server/SMTP Port - The IP address/Port number of the SMTP server.</p> <p>Mail To - Assign a mail address for sending mails out.</p> <p>Return-Path - Assign a path for receiving the mail from outside.</p> <p>Use SSL - Check this box to use port 465 for SMTP server for some e-mail server uses https as the transmission method.</p> <p>Authentication - Check this box to activate this function while using e-mail application.</p> <p>User Name - Type the user name for authentication.</p> <p>Password - Type the password for authentication.</p> <p>Enable E-mail Alert - Check the box to send alert message to the e-mail box while the router detecting the item(s) you specify here.</p> |
|--------------------------------|----------------------------------------------------------------------------------------------------------------------------------------------------------------------------------------------------------------------------------------------------------------------------------------------------------------------------------------------------------------------------------------------------------------------------------------------------------------------------------------------------------------------------------------------------------------------------------------------------------------------------------------------------------------------------------------------------------------------------------------------------------------------------------------------------------------------------------------------------------------------------------------------------------------------------------------------------------------------------------------------------------------------------------------------------------------------------|

Click **OK** to save these settings.

For viewing the Syslog, please do the following:

1. Just set your monitor PC's IP address in the field of Server IP Address
2. Install the Router Tools in the **Utility** within provided CD. After installation, click on the **Router Tools>>Syslog** from program menu.

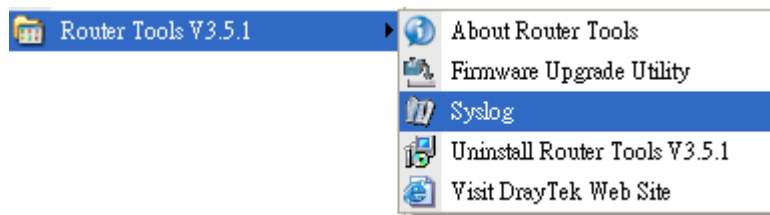

3. From the Syslog screen, select the router you want to monitor. Be reminded that in **Network Information**, select the network adapter used to connect to the router. Otherwise, you won't succeed in retrieving information from the router.

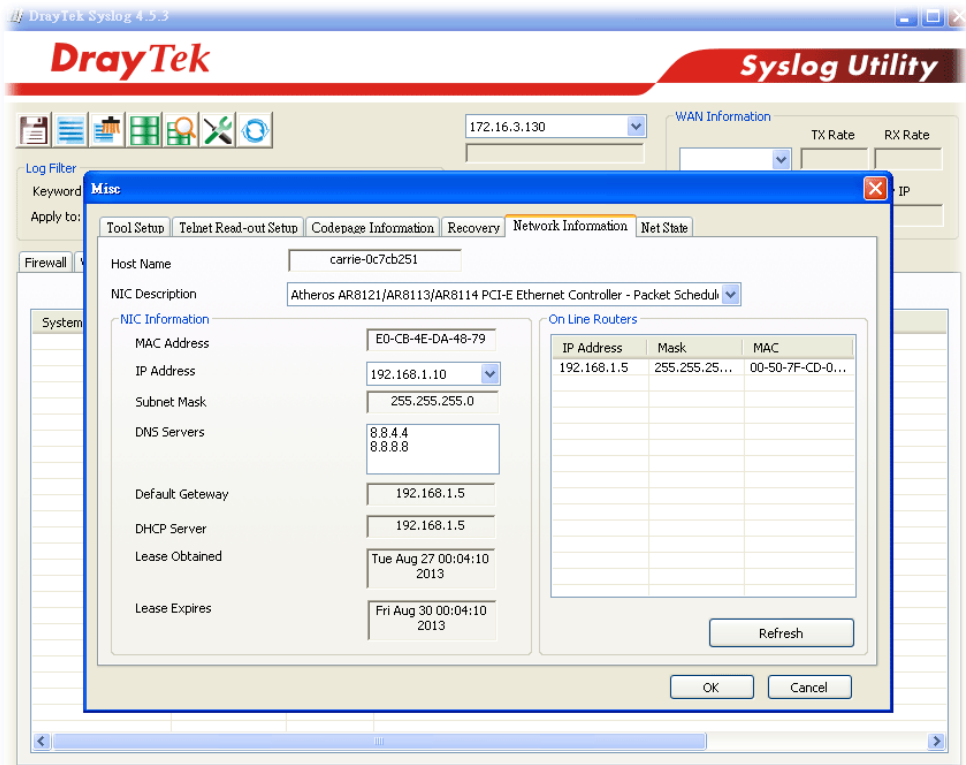

Custom Time: Time has from the computer which runs this custom application.

Default Time: Time has from router.

3.14.8 Time and Date

It allows you to specify where the time of the router should be inquired from.

System Maintenance >> Time and Date

Time Information

Current System Time: 2014 Jan 22 Wed 15 : 18 : 53 Inquire Time

Time Setup

Use Browser Time
 Use Internet Time

Time Server:

Priority: ▼

Time Zone: ▼

Enable Daylight Saving:

Automatically Update Interval: ▼

Available settings are explained as follows:

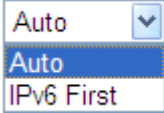
| Item | Description |
|--------------------------------------|-----------------------------------------------------------------------------------------------------------------------------------|
| Current System Time | Click Inquire Time to get the current time. |
| Use Browser Time | Select this option to use the browser time from the remote administrator PC host as router's system time. |
| Use Internet Time | Select to inquire time information from Time Server on the Internet using assigned protocol. |
| Time Server | Type the IP address of the time server. |
| Priority | Choose Auto or IPv6 First as the priority.  |
| Time Zone | Select the time zone where the router is located. |
| Enable Daylight Saving | Check the box to enable the daylight saving. Such feature is available for certain area. |
| Automatically Update Interval | Select a time interval for updating from the NTP server. |

Click **OK** to save these settings.

3.14.9 SNMP

This page allows you to configure settings for SNMP and SNMPV3 services.

The SNMPv3 is **more secure than** SNMP through the encryption method (support AES and DES) and authentication method (support MD5 and SHA) for the management needs.

Applications >> SNMP

SNMP Setup

| | |
|-------------------------------------------------------|--------------------------------------|
| <input checked="" type="checkbox"/> Enable SNMP Agent | |
| Get Community | <input type="text" value="public"/> |
| Set Community | <input type="text" value="private"/> |
| Manager Host IP(IPv4) | <input type="text"/> |
| Manager Host IP(IPv6) | <input type="text"/> |
| Trap Community | <input type="text" value="public"/> |
| Notification Host IP(IPv4) | <input type="text"/> |
| Notification Host IP(IPv6) | <input type="text"/> |
| Trap Timeout | <input type="text" value="10"/> |
| <input type="checkbox"/> Enable SNMPV3 Agent | |
| USM User | <input type="text"/> |
| Auth Algorithm | <input type="text" value="No Auth"/> |
| Auth Password | <input type="text"/> |
| Privacy Algorithm | <input type="text" value="No Priv"/> |
| Privacy Password | <input type="text"/> |

Available settings are explained as follows:

| Item | Description |
|------------------------------------|------------------------------------------------------------------------------------------------------------------------------------------------------------------------|
| Enable SNMP Agent | Check it to enable this function. |
| Get Community | Set the name for getting community by typing a proper character. The default setting is public . The maximum length of the text is limited to 23 characters. |
| Set Community | Set community by typing a proper name. The default setting is private . The maximum length of the text is limited to 23 characters. |
| Manager Host IP (IPv4) | Set one host as the manager to execute SNMP function. Please type in IPv4 address to specify certain host. |
| Manager Host IP (IPv6) | Set one host as the manager to execute SNMP function. Please type in IPv6 address to specify certain host. |
| Trap Community | Set trap community by typing a proper name. The default setting is public . The maximum length of the text is limited to 23 characters. |
| Notification Host IP (IPv4) | Set the IPv4 address of the host that will receive the trap community. |

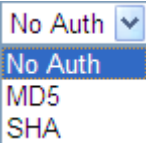
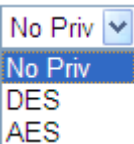
| | |
|------------------------------------|-------------------------------------------------------------------------------------------------------------------------------------------------------------------------|
| Notification Host IP (IPv6) | Set the IPv6 address of the host that will receive the trap community. |
| Trap Timeout | The default setting is 10 seconds. |
| Enable SNMPV3 Agent | Check it to enable this function. |
| USM User | USM means user-based security mode. Type a username which will be used for authentication. The maximum length of the text is limited to 23 characters. |
| Auth Algorithm | Choose one of the encryption methods listed below as the authentication algorithm.  |
| Auth Password | Type a password for authentication. The maximum length of the text is limited to 23 characters. |
| Privacy Algorithm | Choose one of the methods listed below as the privacy algorithm.  |
| Privacy Password | Type a password for privacy. The maximum length of the text is limited to 23 characters. |

Click **OK** to save these settings.

3.14.10 Management

This page allows you to manage the settings for Internet/LAN Access Control, Access List from Internet, Management Port Setup, and External Device Control.

The management pages for IPv4 and IPv6 protocols are different.

For IPv4

System Maintenance >> Management

| IPv4 Management Setup | IPv6 Management Setup | | | | | | | | | | | | |
|-----------------------------------------------------------------------------------------------------------------------------------------------------------------------------------------------------------------------------------------------------------------------------------------------------------------------------------------------------------------------------------------------------------------------------------------------------------------------------------------------------------------------------------------------------------------------------------------------------------------------------------------------------------------------------------------------------------------------------------------------------------------------------------------------------------------------------------------------------------------------------------------------------------------------------------------------------------------------------------------------------------------------------------------------------------------------------------------------------------------------------------------------------------------------------------------------------------------------------------------------------------------------------------------------------------------------------------------------------------------------------------------------------------|-----------------------|----------------------|-------------|---|----------------------|----------------------|---|----------------------|----------------------|---|----------------------|----------------------|-----------------------------------------------------------------------------------------------------------------------------------------------------------------------------------------------------------------------------------------------------------------------------------------------------------------------------------------------------------------------------------------------------------------------------------------------------------------------------------------------------------------------------------------------------------------------------------------------------------|
| Router Name <input type="text"/> <input type="checkbox"/> Default: Disable Auto-Logout Internet Access Control <input checked="" type="checkbox"/> Allow management from the Internet <input type="checkbox"/> FTP Server <input checked="" type="checkbox"/> HTTP Server <input checked="" type="checkbox"/> HTTPS Server <input checked="" type="checkbox"/> Telnet Server <input type="checkbox"/> TR069 Server <input type="checkbox"/> SSH Server <input type="checkbox"/> Disable PING from the Internet LAN Access Control <input checked="" type="checkbox"/> Allow management from LAN <input checked="" type="checkbox"/> FTP Server <input checked="" type="checkbox"/> HTTP Server <input checked="" type="checkbox"/> HTTPS Server <input checked="" type="checkbox"/> Telnet Server <input checked="" type="checkbox"/> SSH Server Apply To <input checked="" type="checkbox"/> LAN2 Access List from the Internet <table border="1"> <thead> <tr> <th>List</th> <th>IP</th> <th>Subnet Mask</th> </tr> </thead> <tbody> <tr> <td>1</td> <td><input type="text"/></td> <td><input type="text"/></td> </tr> <tr> <td>2</td> <td><input type="text"/></td> <td><input type="text"/></td> </tr> <tr> <td>3</td> <td><input type="text"/></td> <td><input type="text"/></td> </tr> </tbody> </table> | List | IP | Subnet Mask | 1 | <input type="text"/> | <input type="text"/> | 2 | <input type="text"/> | <input type="text"/> | 3 | <input type="text"/> | <input type="text"/> | Management Port Setup <input checked="" type="radio"/> User Define Ports <input type="radio"/> Default Ports Telnet Port <input type="text" value="23"/> (Default: 23) HTTP Port <input type="text" value="8276"/> (Default: 80) HTTPS Port <input type="text" value="443"/> (Default: 443) FTP Port <input type="text" value="21"/> (Default: 21) TR069 Port <input type="text" value="8069"/> (Default: 8069) SSH Port <input type="text" value="22"/> (Default: 22) External Device Control <input checked="" type="checkbox"/> No respond to External Device |
| List | IP | Subnet Mask | | | | | | | | | | | |
| 1 | <input type="text"/> | <input type="text"/> | | | | | | | | | | | |
| 2 | <input type="text"/> | <input type="text"/> | | | | | | | | | | | |
| 3 | <input type="text"/> | <input type="text"/> | | | | | | | | | | | |

Note: LAN1 is always allowed to access all the router services regardless of "LAN Access Control" settings.

OK

Available settings are explained as follows:

| Item | Description |
|-------------------------------------|--------------------------------------------------------------------------------------------------------------------------------------------------------------------------------|
| Router Name | Type in the router name provided by ISP. |
| Default: Disable Auto-Logout | If it is enabled, the function of auto-logout for web user interface will be disabled.  |

| | |
|--------------------------------------|-------------------------------------------------------------------------------------------------------------------------------------------------------------------------------------------------------------------------------------------------------------------------------------------------------------------------------------------------------------------------------------------------------------------------------------------|
| | <p>The web user interface will be open until you click the Logout icon manually.</p>  |
| Internet Access Control | <p>Allow management from the Internet - Enable the checkbox to allow system administrators to login from the Internet. There are several servers provided by the system to allow you managing the router from Internet. Check the box(es) to specify.</p> <p>Disable PING from the Internet - Check the checkbox to reject all PING packets from the Internet. For security issue, this function is enabled by default.</p> |
| LAN Access Control | <p>Allow management from LAN- Enable the checkbox to allow system administrators to login from LAN interface. There are several servers provided by the system which allow you to manage the router from LAN interface. Check the box(es) to specify.</p> <p>Apply To – Check the LAN interface for the administrator to use for accessing into web user interface of Vigor router.</p> |
| Access List from the Internet | <p>You could specify that the system administrator can only login from a specific host or network defined in the list. A maximum of three IPs/subnet masks is allowed.</p> <p>List IP - Indicate an IP address allowed to login to the router.</p> <p>Subnet Mask - Represent a subnet mask allowed to login to the router.</p> |
| Management Port Setup | <p>User Define Ports - Check to specify user-defined port numbers for the Telnet, HTTP, HTTPS, FTP, TR-069 and SSH servers.</p> <p>Default Ports - Check to use standard port numbers for the Telnet and HTTP servers.</p> |
| External Device Control | <p>No respond to External Device – Check the box to make Vigor2760 not being detected by other router and not being displayed as an external device.</p> |

After finished the above settings, click **OK** to save the configuration.

For IPv6

System Maintenance >> Management

| IPv4 Management Setup | IPv6 Management Setup |
|-----------------------------------------------------------------------------------------------------------------------------------------------------------------------------------------------------------------------------------------------------------------------------------------------------------------------------------------------------------|-----------------------|
| Management Access Control Allow management from the Internet <input type="checkbox"/> Telnet Server (Port : 23) <input type="checkbox"/> HTTP Server (Port : 2860) <input type="checkbox"/> HTTPS Server (Port : 443) <input type="checkbox"/> SSH Server (Port : 22) <input type="checkbox"/> Enable PING from the Internet | |
| Access List List IPv6 Address / Prefix Length 1. <input type="text"/> / <input type="text"/> 128 2. <input type="text"/> / <input type="text"/> 128 3. <input type="text"/> / <input type="text"/> 128 Note : Telnet / Http server port is the same as IPv4. | |
| <input type="button" value="OK"/> | |

Available settings are explained as follows:

| Item | Description |
|----------------------------------|--------------------------------------------------------------------------------------------------------------------------------------------------------------------------------------------------------------------------------------------------------------------------------------------------------------------------------------------------------------------------------------------------------------------------------|
| Management Access Control | Allow management from the Internet - Enable the checkbox to allow system administrators to login from the Internet. There are several servers provided by the system to allow you managing the router from Internet. Check the box(es) to specify. Enable PING from the Internet - Check the checkbox to enable all PING packets from the Internet. For security issue, this function is disabled by default. |
| Access List | You could specify that the system administrator can only login from a specific host or network defined in the list. A maximum of three IPs/subnet masks is allowed. IPv6 Address /Prefix Length - Indicate the IP address(es) allowed to login to the router. |

After finished the above settings, click **OK** to save the configuration.

3.14.11 Reboot System

The Web user interface may be used to restart your router. Click **Reboot System** from **System Maintenance** to open the following page.

System Maintenance >> Reboot System

Reboot System

Do you want to reboot your router ?

Using current configuration
 Using factory default configuration

Reboot Now

Auto Reboot Time Schedule

Index(1-15) in Schedule Setup: , , ,

Note: Action and Idle Timeout settings will be ignored.

OK

Cancel

Index (1-15) in Schedule Setup - You can type in four sets of time schedule for performing system reboot. All the schedules can be set previously in **Applications >> Schedule** web page and you can use the number that you have set in that web page.

If you want to reboot the router using the current configuration, check **Using current configuration** and click **Reboot Now**. To reset the router settings to default values, check **Using factory default configuration** and click **Reboot Now**. The router will take 5 seconds to reboot the system.

Note: When the system pops up Reboot System web page after you configure web settings, please click **Reboot Now** to reboot your router for ensuring normal operation and preventing unexpected errors of the router in the future.

3.14.12 Firmware Upgrade

Before upgrading your router firmware, you need to install the Router Tools. The **Firmware Upgrade Utility** is included in the tools. The following web page will guide you to upgrade firmware by using an example. Note that this example is running over Windows OS (Operating System).

Download the newest firmware from DrayTek's web site at www.draytek.co.uk (for users in the UK/Ireland). **Be sure to download and use only the correct firmware for your model. The original Vigor 2760 can use firmware 1.x.x only. Later 'Delight' series Vigor 2760 can use firmware 3.7.5 or later only.**

Click **System Maintenance>> Firmware Upgrade** to launch the Firmware Upgrade Utility.

System Maintenance >> Firmware Upgrade

Web Firmware Upgrade

Select a firmware file.

Click Upgrade to upload the file.

TFTP Firmware Upgrade from LAN

Current Firmware Version: 3.7.5_RC4

Firmware Upgrade Procedures:

1. Click "OK" to start the TFTP server.
2. Open the Firmware Upgrade Utility or other 3-party TFTP client software.
3. Check that the firmware filename is correct.
4. Click "Upgrade" on the Firmware Upgrade Utility to start the upgrade.
5. After the upgrade is complete, the TFTP server will automatically stop running.

Do you want to upgrade firmware ?

Click **OK**. The following screen will appear. Please execute the firmware upgrade utility first.

System Maintenance >> Firmware Upgrade

 TFTP server is running. Please execute a Firmware Upgrade Utility software to upgrade router's firmware. This server will be closed by itself when the firmware upgrading finished.

For the detailed information about firmware update, please go to Chapter 5.

3.14.13 DSL Firmware Upgrade

This function is used to upgrade modem code if you find built-in modem code is not suitable for your location/line. Contact with your dealer for further assistance if required.

System Maintenance >> Modem Code Upgrade

Web DSL Modem Code Upgrade

Select a modem code file.

Click Upgrade to upload the file.

3.14.14 Activation

There are three ways to activate WCF on vigor router, using **Service Activation Wizard**, by means of **CSM>>Web Content Filter Profile** or via **System Maintenance>>Activation**.

After you have finished the setting profiles for WCF (refer to **Web Content Filter Profile**), it is the time to activate the mechanism for your computer.

Click **System Maintenance>>Activation** to open the following page for accessing <http://myvigor.draytek.com>.

System Maintenance >> Activation Activate via interface : auto-selected ▼

Web-Filter License [Activate](#)
 [Status:Not Activated]

Authentication Message

Note: If you want to use email alert or syslog, please configure the [SysLog/Mail Alert Setup](#) page.
 If you change the service provider, the configuration of the function will be reset.

Available settings are explained as follows:

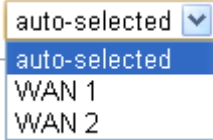
| Item | Description |
|-------------------------------|-------------------------------------------------------------------------------------------------------------------------------------------------------------------------|
| Activate via Interface | Choose WAN interface used by such device for activating Web Content Filter.  |
| Activate | The Activate link brings you accessing into myvigor.draytek.com to finish the activation of the account and the router. |

| | |
|-------------------------------|--------------------------------------------------------------------------------------------------------------------------------------------|
| Authentication Message | As for authentication information of web filter , the process of authenticating will be displayed on this field for your reference. |
|-------------------------------|--------------------------------------------------------------------------------------------------------------------------------------------|

Below shows the successful activation of Web Content Filter:

System Maintenance >> Activation Activate via interface:

Web-Filter License [Activate](#)
 [Status: **CommTouch**] [Start Date: **2011-03-28** Expire Date: **2011-04-27**]

Authentication Message

```
WebFilter, Activation authenticate fail, contact with support@draytek.com, 2011-03-28 01:00:24
```

Note: If you want to use email alert or syslog, please configure the [SysLog/Mail Alert Setup](#) page.
 If you change the service provider, the configuration of the function will be reset.

3.15 Diagnostics

Dagnostic Tools provide a useful way to **view** or **diagnose** the status of your Vigor router. Below shows the menu items for Diagnostics.

System Maintenance

- Diagnostics**
- Dial-out Triggering
- Routing Table
- ARP Cache Table
- IPv6 Neighbour Table
- DHCP Table
- NAT Sessions Table
- Ping Diagnosis
- Data Flow Monitor
- Traffic Graph
- Trace Route
- Syslog Explorer
- IPv6 TSPC Status

3.15.1 Dial-out Triggering

Click **Diagnostics** and click **Dial-out Triggering** to open the web page. The internet connection (e.g., PPPoE) is triggered by a package sending from the source IP address.

Diagnostics >> Dial-out Triggering

Dial-out Triggered Packet Header | [Refresh](#) |

HEX Format:

```
00 00 00 00 00 00 00-00 00 00 00 00 00-00 00
```



```
00 00 00 00 00 00 00 00 00-00 00 00 00 00 00 00 00
00 00 00 00 00 00 00 00 00-00 00 00 00 00 00 00 00
00 00 00 00 00 00 00 00 00-00 00 00 00 00 00 00 00
00 00 00 00 00 00 00 00 00-00 00 00 00 00 00 00 00
00 00 00 00 00 00 00 00 00-00 00 00 00 00 00 00 00
```

Decoded Format:

```
0.0.0.0 -> 0.0.0.0
Pr 0 len 0 (0)
```

Available settings are explained as follows:

| Item | Description |
|-----------------------|------------------------------------------------------------------------------------------------------------------|
| Decoded Format | It shows the source IP address (local), destination IP (remote) address, the protocol and length of the package. |
| Refresh | Click it to reload the page. |

3.15.2 Routing Table

Click **Diagnostics** and click **Routing Table** to open the web page.

Diagnostics >> View Routing Table

| Current Running Routing Table | | IPv6 Routing Table | | Refresh |
|-------------------------------------------------------------------|--------------|--------------------|--------------------|---------|
| Key: C - connected, S - static, R - RIP, * - default, ~ - private | | | | |
| C | 10.39.0.0/ | 255.255.255.0 | directly connected | LAN2 |
| C~ | 192.168.1.0/ | 255.255.255.0 | directly connected | LAN1 |
| S | 172.16.0.0/ | 255.255.0.0 | via 10.39.0.1 | LAN2 |

Note: WAN4, WAN5, WAN6 are router-borne WANs.

Diagnostics >> View Routing Table

| Current Running Routing Table | | IPv6 Routing Table | | Refresh |
|-------------------------------|-----------|--------------------|--------|----------|
| Destination | Interface | Flags | Metric | Next Hop |
| FE80::/64 | LAN | U | 256 | |
| FF00::/8 | LAN | U | 256 | |

Available settings are explained as follows:

| Item | Description |
|---------|------------------------------|
| Refresh | Click it to reload the page. |

3.15.3 ARP Cache Table

Click **Diagnostics** and click **ARP Cache Table** to view the content of the ARP (Address Resolution Protocol) cache held in the router. The table shows a mapping between an Ethernet hardware address (MAC Address) and an IP address.

[Diagnostics >> View ARP Cache Table](#)

| Ethernet ARP Cache Table | | | | Clear Refresh |
|--------------------------|-------------------|-----------------|-----------|-------------------------------------------------|
| IP Address | MAC Address | Netbios Name | Interface | |
| 192.168.1.5 | 00-50-7F-CD-07-48 | | LAN1 | |
| 192.168.1.49 | E0-CB-4E-DA-48-79 | CARRIE-0C7CB251 | LAN1 | |

Available settings are explained as follows:

| Item | Description |
|----------------|------------------------------|
| Refresh | Click it to reload the page. |

3.15.4 IPv6 Neighbour Table

The table shows a mapping between an Ethernet hardware address (MAC Address) and an IPv6 address. This information is helpful in diagnosing network problems, such as IP address conflicts, etc.

Click **Diagnostics** and click **IPv6 Neighbour Table** to open the web page.

[Diagnostics >> View IPv6 Neighbour Table](#)

| IPv6 Neighbour Table | | | Refresh |
|---------------------------|-------------------|-----------|-------------------------|
| IPv6 Address | Mac Address | Interface | |
| FF02::2 | 33-33-00-00-00-02 | LAN | |
| FF02::1:3 | 33-33-00-01-00-03 | LAN | |
| FE80::3D5E:E74:8751:A44B | e8-9d-87-87-69-2f | LAN | |
| FF02::1:FF51:A44B | 33-33-ff-51-a4-4b | LAN | |
| FE80::250:7FFF:FEC9:1E79 | 00-50-7f-c9-1e-79 | LAN | |
| FE80::250:7FFF:FEC8:4305 | 00-50-7f-c8-43-05 | LAN | |
| FF02::1 | 33-33-00-00-00-01 | LAN | |
| FF02::1 | 00-00-00-00-00-00 | USB2 | |
| FF02::1:2 | 00-00-00-00-00-00 | USB2 | |
| FE80::9D5C:CA86:5428:3CA7 | 00-26-2d-fe-63-4f | LAN | |
| FF02::1:FF0A:673C | 33-33-ff-0a-67-3c | LAN | |

Available settings are explained as follows:

| Item | Description |
|------|-------------|
|------|-------------|

| | |
|----------------|------------------------------|
| Refresh | Click it to reload the page. |
|----------------|------------------------------|

3.15.5 DHCP Table

The facility provides information on IP address assignments. This information is helpful in diagnosing network problems, such as IP address conflicts, etc.

Click **Diagnostics** and click **DHCP Table** to open the web page.

Diagnostics >> View DHCP Assigned IP Addresses

| DHCP IP Assignment Table | DHCPv6 IP Assignment Table | Refresh |
|----------------------------------------------------|----------------------------|---------|
| LAN1 : 192.168.1.1/255.255.255.0, DHCP server: Off | | |

Diagnostics >> View DHCP Assigned IP Addresses

| DHCP IP Assignment Table | DHCPv6 IP Assignment Table | Refresh |
|-------------------------------|----------------------------|------------------------------|
| DHCPv6 server binding client: | | |
| Index | IPv6 Address | MAC Address Leased Time |

Available settings are explained as follows:

| Item | Description |
|--------------------|----------------------------------------------------------------------------------------|
| Index | It displays the connection item number. |
| IP Address | It displays the IP address assigned by this router for specified PC. |
| MAC Address | It displays the MAC address for the specified PC that DHCP assigned IP address for it. |
| Leased Time | It displays the leased time of the specified PC. |

| | |
|----------------|---------------------------------------------------|
| HOST ID | It displays the host ID name of the specified PC. |
| Refresh | Click it to reload the page. |

3.15.6 NAT Sessions Table

Click **Diagnostics** and click **NAT Sessions Table** to open the list page.

Diagnostics >> NAT Sessions Table

NAT Active Sessions Table | Refresh |

| Private IP :Port | #Pseudo Port | Peer IP :Port | Interface |
|-------------------|--------------|-----------------|-----------|
| 192.168.1.11 2491 | 52078 | 24.9.93.189 443 | WAN1 |
| 192.168.1.11 2493 | 52080 | 207.46.25.2 80 | WAN1 |
| 192.168.1.10 3079 | 52665 | 207.46.5.10 80 | WAN1 |

Available settings are explained as follows:

| Item | Description |
|------------------------|------------------------------------------------------------------|
| Private IP:Port | It indicates the source IP address and port of local PC. |
| #Pseudo Port | It indicates the temporary port of the router used for NAT. |
| Peer IP:Port | It indicates the destination IP address and port of remote host. |
| Interface | It displays the representing number for different interface. |
| Refresh | Click it to reload the page. |

3.15.7 Ping Diagnosis

Click **Diagnostics** and click **Ping Diagnosis** to pen the web page.

Diagnostics >> Ping Diagnosis

Ping Diagnosis

IPv4 IPv6
 Note: If you want to ping a LAN PC or you don't want to specify which WAN to ping through, please select "Unspecified".
 Ping through: v
 Ping to: Host / IP v IP Address:
Host / IP
DNS
Gateway 1
Gateway 2
Gateway 3

Result | [Clear](#) |

Diagnostics >> Ping Diagnosis

Ping Diagnosis

IPv4 IPv6
 Ping IPv6 Address:

Result | [Clear](#) |

Available settings are explained as follows:

| Item | Description |
|--------------------------|-------------------------------------------------------------------------------------------------------------------------------------------------------------|
| IPv4 /IPv6 | Choose the interface for such function. |
| Ping through | Use the drop down list to choose the WAN interface that you want to ping through or choose Unspecified to be determined by the router automatically. |
| Ping to | Use the drop down list to choose the destination that you want to ping. |
| IP Address | Type the IP address of the Host/IP that you want to ping. |
| Ping IPv6 Address | Type the IPv6 address that you want to ping. |

Available settings are explained as follows:

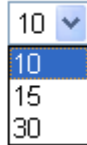
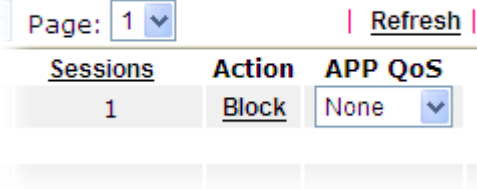
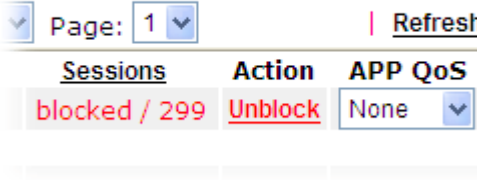
| Item | Description |
|---------------------------------|--------------------------------------------------------------------------------------------------------------------------------------------------------------------------------------------------------------------------------------------------------------------------------------------------------------------------------------------------------------------------------------------------------------------|
| Enable Data Flow Monitor | Check this box to enable this function. |
| Refresh Seconds | Use the drop down list to choose the time interval of refreshing data flow that will be done by the system automatically. Refresh Seconds:  |
| Refresh | Click this link to refresh this page manually. |
| Index | Display the number of the data flow. |
| IP Address | Display the IP address of the monitored device. |
| TX rate (kbps) | Display the transmission speed of the monitored device. |
| RX rate (kbps) | Display the receiving speed of the monitored device. |
| Sessions | Display the session number that you specified in Limit Session web page. |
| Action | <p>Block - can prevent specified PC accessing into Internet within 5 minutes.</p>  <p>Unblock – the device with the IP address will be blocked in five minutes. The remaining time will be shown on the session column.</p>  |
| Current /Peak/Speed | <p>Current means current transmission rate and receiving rate for WAN interface.</p> <p>Peak means the highest peak value detected by the router in data transmission.</p> <p>Speed means line speed specified in WAN>>General Setup. If you do not specify any rate at that page, here will display Auto for instead.</p> |

3.15.9 Traffic Graph

Click **Diagnostics** and click **Traffic Graph** to pen the web page. Choose WAN1/WAN2/WAN3 Bandwidth, Sessions, daily or weekly for viewing different traffic graph. Click **Reset** to zero the accumulated RX/TX (received and transmitted) data of WAN. Click **Refresh** to renew the graph at any time.

Diagnostics >> Traffic Graph

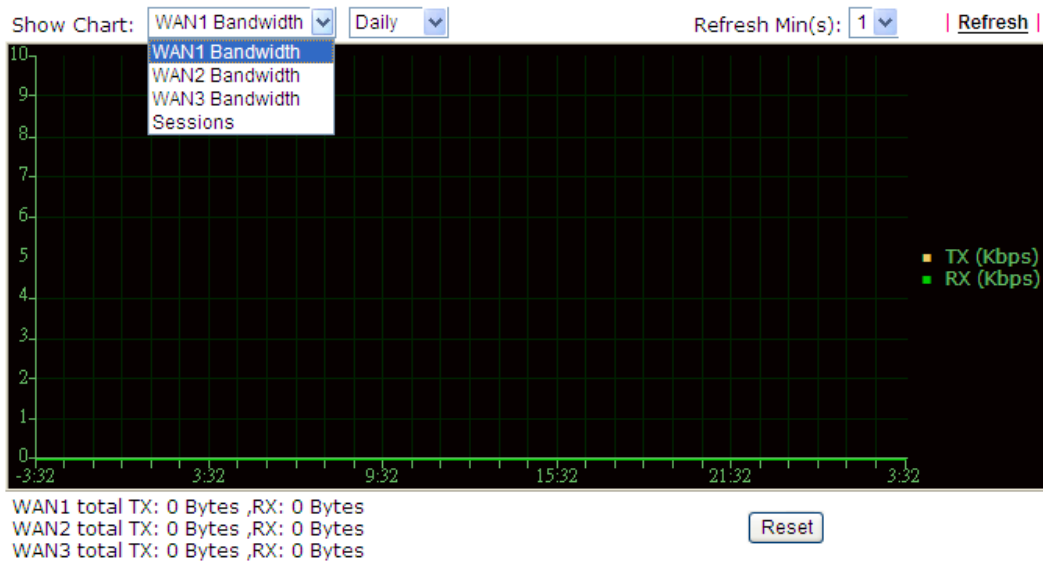

The horizontal axis represents time. Yet the vertical axis has different meanings. For WAN1/WAN2/WAN3 Bandwidth chart, the numbers displayed on vertical axis represent the numbers of the transmitted and received packets in the past.

For Sessions chart, the numbers displayed on vertical axis represent the numbers of the NAT sessions during the past.

3.15.10 Trace Route

Click **Diagnostics** and click **Trace Route** to open the web page. This page allows you to trace the routes from router to the host. Simply type the IP address of the host in the box and click **Run**. The result of route trace will be shown on the screen.

Diagnostics >> Trace Route

Trace Route

IPv4 IPv6
 Trace through: ▼
 Protocol: ▼
 Host / IP Address:

Result | [Clear](#) |

or

Diagnostics >> Trace Route

Trace Route

IPv4 IPv6
 Trace Host / IP Address:

Result | [Clear](#) |

Available settings are explained as follows:

| Item | Description |
|----------------------|-------------------------------------------------------------------------------|
| IPv4 / IPv6 | Click one of them to display corresponding information for it. |
| Trace through | Use the drop down list to choose the interface that you want to ping through. |

| | |
|------------------------------|------------------------------------------------------------------------------|
| Protocol | Use the drop down list to choose the protocol that you want to ping through. |
| Host/IP Address | It indicates the IP address of the host. |
| Trace Host/IP Address | It indicates the IPv6 address of the host. |
| Run | Click this button to start route tracing work. |
| Clear | Click this link to remove the result on the window. |

3.15.11 Syslog Explorer

Such page provides real-time syslog and displays the information on the screen.

For Web Syslog

This page displays the time and message for User/Firewall/call/WAN/VPN settings. You can check **Enable Web Syslog**, specify the type of Syslog and choose the display mode you want. Later, the event of Syslog with specified type will be shown for your reference.

Diagnostics >> Syslog Explorer

Available settings are explained as follows:

| Item | Description |
|--------------------------|------------------------------------------------------------------------------------------------------------------------------------------------------------|
| Enable Web Syslog | Check this box to enable the function of Web Syslog. |
| Syslog Type | Use the drop down list to specify a type of Syslog to be displayed.  |
| Export | Click this link to save the data as a file. |
| Refresh | Click this link to refresh this page manually. |
| Clear | Click this link to clear information on this page. |
| Display Mode | There are two modes for you to choose. |

| | |
|----------------|-----------------------------------------------------------------------------------------------------------------------------------------------------------------------------------------------------------------------------------------------------------------------------------------------------------------------------------------------------------------------------------------------------------------------------------|
| | <div style="border: 1px solid black; padding: 2px;"> Stop record when fulls ▼ Stop record when fulls Always record the new event </div> <p>Stop record when fulls – when the capacity of syslog is full, the system will stop recording.</p> <p>Always record the new event – only the newest events will be recorded by the system.</p> |
| Time | Display the time of the event occurred. |
| Message | Display the information for each event. |

For USB Syslog

This page displays the syslog recorded on the USB storage disk.

Diagnostics >> Syslog Explorer

| | |
|------------|------------|
| Web Syslog | USB Syslog |
|------------|------------|

Note: The syslog will show while the saved syslog file size is over 1MB.

Folder: n/a File: n/a Page: n/a Log Type: n/a

| Time | Log Type | Message |
|------|----------|---------|
|------|----------|---------|

Available settings are explained as follows:

| Item | Description |
|-----------------|-----------------------------------------|
| Time | Display the time of the event occurred. |
| Log Type | Display the type of the record. |
| Message | Display the information for each event. |

3.15.12 IPv6 TSPC Status

IPv6 TSPC status web page could help you to diagnose the connection status of TSPC.

If TSPC has configured properly, the router will display the following page when the user connects to tunnel broker successfully.

Diagnostics >> IPv6 TSPC Status

| WAN1 | WAN2 | WAN3 | Refresh |
|-------------------------------------|------|-----------------------------------------|---------|
| TSPC Enabled | | | |
| TSPC Connection Status | | | |
| Local Endpoint v4 Address : | | 114.44.54.220 | |
| Local Endpoint v6 Address : | | 2001:05c0:1400:000b:0000:0000:0000:10b9 | |
| Router DNS name : | | 88886666.broker.freenet6.net | |
| Remote Endpoint v4 Address : | | 81.171.72.11 | |
| Remote Endpoint v6 Address : | | 2001:05c0:1400:000b:0000:0000:0000:10b8 | |
| Tspc Prefix : | | 2001:05c0:1502:0d00:0000:0000:0000:0000 | |
| Tspc Prefixlen : | | 56 | |
| Tunnel Broker : | | amsterdam.freenet6.net | |
| Tunnel Status : | | Connected | |

Available settings are explained as follows:

| Item | Description |
|---------|------------------------------------------------|
| Refresh | Click this link to refresh this page manually. |

4

Tutorials and Applications

4.1 How to configure settings for IPv6 Service in Vigor2760

Due to the shortage of IPv4 address, more and more countries use IPv6 to solve the problem. However, to continually use the original rich resources of IPv4, both IPv6 and IPv4 networks shall communicate for each other via intercommunication mechanism to complete the shifting job from IPv4 to IPv6 gradually. At present, there are three common types of intercommunication mechanisms:

- **Dual Stack**

The user can use both IPv4 and IPv6 techniques at the same time. That means adding an IPv6 stack on the origin network layer to let the host own the communication capability of IPv4 and IPv6.

- **Tunnel**

Both IPv6 hosts can communication for each other via existing IPv4 network environment. The IPv6 packets will be encapsulated with the header of IPv4 first. Later, the packets will be transformed and judged by IPv4 router. Once the packets arrive the border between IPv4 and IPv6, the header of IPv4 on the packets will be removed. Then, the packets with IPv6 address will be forwarded to the destination of IPv6 network.

- **Translation**

Such feature is active only for the user who uses IPv4 to communicate with other user using IPv4 service.

Before configuring the settings on Vigor2760, you need to know which connection type that your IPv6 service used.

Note: For the IPv6 service, you have to configure WAN/LAN settings before using the service.

I. Configuring the WAN Settings

For the IPv6 WAN settings for Vigor2760, there are five connection types to be chosen: PPP, TSPC, AICCU, DHCPv6 Client, Static IPv6, 6in4 Static Tunnel and 6rd.

1. Access into the web user interface of Vigor2760. Open **WAN>> Internet Access**. Choose one of the WAN interfaces as the one supporting IPv6 service. Then, click the IPv6 button of the selected WAN.

WAN >> Internet Access

Internet Access

| Index | Display Name | Physical Mode | Access Mode | | |
|-------|--------------|---------------|----------------------|--------------|------|
| WAN1 | | ADSL / VDSL2 | None | Details Page | IPv6 |
| WAN2 | | Ethernet | Static or Dynamic IP | Details Page | IPv6 |
| WAN3 | | USB | None | Details Page | IPv6 |

Note: Only one WAN can support IPv6.

Note: Only one WAN interface support IPv6 service at one time. In this example, WAN2 is chosen as the one supporting IPv6 service.

- In the following figure, use the drop down list to choose a proper connection type.

WAN 2

| PPPoE | Static or Dynamic IP | PPTP | IPv6 |
|-----------------------------------|----------------------|---------------------------------------------------------------------------------------------------------------------------------------------------------------------------------------------------------------------------------------------------------------------------------------|------|
| Internet Access Mode | | | |
| Connection Type | | <div style="border: 1px solid black; padding: 2px;"> Offline Offline PPP TSPC AICCU DHCPv6 Client Static IPv6 6in4 Static Tunnel 6rd </div> | |
| <input type="button" value="OK"/> | | | |

Different connection types will bring out different configuration page. Refer to the following:

- PPP – Dual Stack application, IPv4 and IPv6 services can be utilized at the same time**

Choose PPP and type the information for PPPoE of IPv4.

WAN >> Internet Access

WAN 2

| PPPoE | Static or Dynamic IP | PPTP/L2TP | IPv6 |
|----------------------------------------------------------------------------------------------------------------------------------------------------------------------------------------------------------------------------------------------------------------------------|----------------------|--------------------------------------------------------------------------------------------------------------------------------------------------------------------------------------------------------------------------------------------------------------------------------------------------------------------------------------------------------------------------------------------------------------------------------------------------------------------------------------------------------------------------------------------------------------|------|
| <input checked="" type="radio"/> Enable <input type="radio"/> Disable | | | |
| ISP Access Setup Username: <input type="text" value="73768635@hinet.net"/> Password: <input type="password" value="....."/> Index(1-15) in Schedule Setup: => <input type="text"/> , <input type="text"/> , <input type="text"/> , <input type="text"/> | | PPP/MP Setup PPP Authentication: <input type="text" value="PAP or CHAP"/> Idle Timeout: <input type="text" value="-1"/> second(s) | |
| WAN Connection Detection Mode: <input type="text" value="ARP Detect"/> Ping IP: <input type="text"/> TTL: <input type="text"/> MTU: <input type="text" value="1442"/> (Max:1492) | | IP Address Assignment Method (IPCP) <input type="button" value="WAN IP Alias"/> Fixed IP: <input type="radio"/> Yes <input checked="" type="radio"/> No (Dynamic IP) Fixed IP Address: <input type="text"/> <input checked="" type="radio"/> Default MAC Address <input type="radio"/> Specify a MAC Address MAC Address: <input type="text" value="00"/> . <input type="text" value="1D"/> . <input type="text" value="AA"/> . <input type="text" value="A8"/> . <input type="text" value="B7"/> . <input type="text" value="6A"/> | |
| <input type="button" value="OK"/> <input type="button" value="Cancel"/> | | | |

Access into the setting page for IPv6 service, it is not necessary for you to configure anything.

WAN >> Internet Access

WAN 2

| PPPoE | Static or Dynamic IP | PPTP/L2TP | IPv6 |
|-------------------------------------------------------------------------|----------------------|-----------------------------------------------------------------------------------|------|
| Internet Access Mode | | | |
| Connection Type | | <div style="border: 1px solid black; padding: 2px;"> PPP </div> | |
| Note: IPv4 WAN setting should be PPPoE client. | | | |
| <input type="button" value="OK"/> <input type="button" value="Cancel"/> | | | |

Click **OK** and open **Online Status** (all screens will vary depending on model). If the connection is successful, you will get the IP address for IPv4 and IPv6 at the same time.

Online Status

| Physical Connection | | | | | | System Uptime: 0:1:17 |
|--------------------------------------------------------------------|---------------|---------------------------|--------------|---------------------------|--------------|-----------------------|
| IPv4 | | | IPv6 | | | |
| LAN Status | | Primary DNS: 168.95.192.1 | | Secondary DNS: 168.95.1.1 | | |
| IP Address | TX Packets | RX Packets | | | | |
| 192.168.1.1 | 0 | 3085 | | | | |
| WAN 1 Status >> Dial PPPoE | | | | | | |
| Enable | Line | Name | Mode | Up Time | | |
| Yes | ADSL | | PPPoE | 00:00:00 | | |
| IP | GW IP | TX Packets | TX Rate(Bps) | RX Packets | RX Rate(Bps) | |
| --- | --- | 0 | 0 | 0 | 0 | |
| WAN 2 Status >> Drop PPPoE | | | | | | |
| Enable | Line | Name | Mode | Up Time | | |
| Yes | Ethernet | | PPPoE | 0:00:54 | | |
| IP | GW IP | TX Packets | TX Rate(Bps) | RX Packets | RX Rate(Bps) | |
| 114.44.49.54 | 168.95.98.254 | 800 | 4761 | 821 | 6617 | |
| WAN 3 Status | | | | | | |
| Enable | Line | Name | Mode | Up Time | Signal | |
| Yes | USB | | --- | 00:00:00 | - | |
| IP | GW IP | TX Packets | TX Rate(Bps) | RX Packets | RX Rate(Bps) | |
| --- | --- | 0 | 0 | 0 | 0 | |
| ADSL Information (ADSL Firmware Version: 05-04-04-04-00-01) | | | | | | |
| ATM Statistics | | TX Cells | RX Cells | TX CRC errs | RX CRC errs | |
| | | 0 | 0 | 0 | 0 | |
| ADSL Status | Mode | State | Up Speed | Down Speed | SNR Margin | Loop Att. |
| | | READY | 0 | 0 | 0 | 0 |

Online Status

| Physical Connection | | | | | | System Uptime: 0:2:32 |
|-----------------------------------------------------|------------|----------|------------------------|----------|--|-----------------------|
| IPv4 | | | IPv6 | | | |
| LAN Status | | | | | | |
| IP Address | | | | | | |
| 2001:B010:7300:201:21D:AFF:FEA6:2568/64 (Global) | | | | | | |
| FE80::21D:AFF:FEA6:2568/64 (Link) | | | | | | |
| TX Packets | RX Packets | TX Bytes | | RX Bytes | | |
| 7 | 4 | 690 | | 328 | | |
| WAN2 IPv6 Status >> Drop PPP | | | | | | |
| Enable | Mode | Up Time | | | | |
| Yes | PPP | 0:02:08 | | | | |
| IP | | | Gateway IP | | | |
| 2001:B010:7300:201:21D:AFF:FEA6:256A/128 (Global) | | | FE80::90:1A00:242:AD52 | | | |
| FE80::1D:AFF:FEA6:256A/128 (Link) | | | | | | |
| DNS IP | | | | | | |
| 2001:B000:168::1 | | | | | | |
| 2001:B000:168::2 | | | | | | |
| TX Packets | RX Packets | TX Bytes | | RX Bytes | | |
| 7 | 9 | 544 | | 1126 | | |

- **TSPC – Tunnel application, both IPv6 hosts communicate through IPv4 network**

Choose **TSPC** and type the information for TSPC service.

Note: While using such mode, you have to make sure the IPv4 network connection is normal.

(In the following figure, the TSPC information is obtained from <http://gogo6.com/> after applied for the service.)

WAN >> Internet Access

WAN 2

| PPPoE | Static or Dynamic IP | PPTP/L2TP | IPv6 |
|----------------------|----------------------|---------------------|------|
| Internet Access Mode | | | |
| Connection Type | | TSPC | |
| TSPC Configuration | | | |
| Username | | cacahsu | |
| Password | | •••••• | |
| Confirm Password | | •••••• | |
| Tunnel Broker | | broker.freenet6.net | |

Click **OK** and open **Online Status**. If the connection is successful, the physical connection will be shows as follows:

Online Status

Physical Connection System Uptime: 0:23

| IPv4 | | IPv6 | |
|-------------------------------------------------|-------------------|-----------------|-------------------|
| LAN Status | | | |
| IP Address | | | |
| 2001:5C0:1502:D00:21D:AFF:FEA6:2568/64 (Global) | | | |
| FE80::21D:AFF:FEA6:2568/64 (Link) | | | |
| TX Packets | RX Packets | TX Bytes | RX Bytes |
| 88 | 121 | 15596 | 10249 |
| WAN2 IPv6 Status | | | |
| Enable | Mode | Up Time | |
| Yes | TSPC | 0:01:40 | |
| IP | | | Gateway IP |
| 2001:5C0:1400:B::10B9/128 (Global) | | | --- |
| FE80::722C:3559/128 (Link) | | | |
| TX Packets | RX Packets | TX Bytes | RX Bytes |
| 127 | 89 | 9219 | 15866 |

- **AICCU – Tunnel application**

Choose AICCU and type the information for AICCU of IPv6.

Note: While using such mode, you have to make sure the IPv4 network connection is normal.

(In the following figure, the AICCU information is obtained from <https://www.sixxs.net/main/> after applied for the service.)

WAN >> Internet Access

WAN 2

| PPPoE | Static or Dynamic IP | PPTP/L2TP | IPv6 |
|------------------------------------|----------------------|-----------------------------|------|
| Internet Access Mode | | | |
| Connection Type | | AICCU | |
| AICCU Configuration | | | |
| <input type="checkbox"/> Always On | | | |
| Username | | JCR3-SIXXS | |
| Password | | ••••• | |
| Confirm Password | | ••••• | |
| Tunnel Broker | | tic.sixxs.net | |
| Subnet Prefix | | 2001:4DD0:FF00:8805::2 / 64 | |

Note: If "Always On" is not enabled, AICCU connection would only retry three times.

Click **OK** and open **Online Status**. If the connection is successful, the physical connection will be shows as follows:

Online Status

Physical Connection System Uptime: 0:1:18

| IPv4 | | IPv6 | |
|---------------------------------------------------|-------------------|-------------------|-----------------|
| LAN Status | | | |
| IP Address | | | |
| 2001:4DD0:FF00:83E4:21D:AFF:FEA6:2568/64 (Global) | | | |
| FE80::21D:AFF:FEA6:2568/64 (Link) | | | |
| TX Packets | RX Packets | TX Bytes | RX Bytes |
| 147 | 187 | 34205 | 19176 |
| WAN2 IPv6 Status | | | |
| Enable | Mode | Up Time | |
| Yes | AICCU | 0:00:48 | |
| IP | | Gateway IP | |
| 2001:4DD0:FF00:3E4::2/64 (Global) | | --- | |
| FE80::4CD0:FF00:3E4:2/64 (Link) | | | |
| TX Packets | RX Packets | TX Bytes | RX Bytes |
| 186 | 137 | 16438 | 33093 |

- **DHCPv6 Client**

Choose DHCPv6 Client. Click one of the identity associations and type the IAID number.

WAN >> Internet Access

WAN 2

| PPPoE | Static or Dynamic IP | PPTP/L2TP | IPv6 |
|--------------------------------|----------------------|------------------------------------------------------------------------------------------------|------|
| Internet Access Mode | | | |
| Connection Type | | DHCPv6 Client | |
| DHCPv6 Client Configuration | | | |
| Identity Association | | <input type="radio"/> Prefix Delegation <input checked="" type="radio"/> Non-temporary Address | |
| IAID (Identity Association ID) | | 972573680 | |
| OK | | Cancel | |

Click **OK** and open **Online Status**. If the connection is successful, the physical connection will be shown as follows:

Online Status

Physical Connection System Uptime: 0:0:50

| IPv4 | | IPv6 | |
|---------------------------------------------------|-------------------|-----------------|-----------------|
| LAN Status | | | |
| IP Address | | | |
| FE80::21D:AFF:FEA6:2568/64 (Link) | | | |
| TX Packets | RX Packets | TX Bytes | RX Bytes |
| 6 | 2 | 588 | 156 |
| WAN2 IPv6 Status | | | |
| Enable | Mode | Up Time | |
| Yes | DHCPv6 Client | 0:00:40 | |
| IP | Gateway IP | | |
| 2001:8010:7300:201:21D:AFF:FEA6:256A/64 (Global) | --- | | |
| 2001:1111:2222:5555:21D:AFF:FEA6:256A/64 (Global) | | | |
| 2001:1111:2222:3333::1111/128 (Global) | | | |
| FE80::21D:AFF:FEA6:256A/64 (Link) | | | |
| DNS IP | | | |
| 2001:4860:4860::8888 | | | |
| 2001:4860:4860::8844 | | | |
| TX Packets | RX Packets | TX Bytes | RX Bytes |
| 14 | 5 | 1174 | 694 |

- **Static IPv6**

Choose Static IPv6. Type IPv6 address, Prefix Length and Gateway Address.

WAN >> Internet Access

WAN 2

Static or Dynamic IP

Internet Access Mode

Connection Type: Static IPv6

Static IPv6 Address configuration

IPv6 Address: 2001:B010:7300:201:21D::AAFF:FEA6:256A / Prefix Length: 64

Current IPv6 Address Table

| Index | IPv6 Address/Prefix Length | Scope |
|-------|--------------------------------------------|--------|
| 1 | 2001:B010:7300:201:21D::AAFF:FEA6:256A/64 | Global |
| 2 | 2001:1111:2222:5555:21D::AAFF:FEA6:256A/64 | Global |
| 3 | FE80::21D::AAFF:FEA6:256A/64 | Link |

Static IPv6 Gateway configuration

IPv6 Gateway Address: ::

OK Cancel

Click **OK** and open **Online Status**. If the connection is successful, the physical connection will be shown as follows:

Online Status

Physical Connection System Uptime: 0:4:2

| IPv4 | | IPv6 | |
|-----------------------------------------------------|-------------------|-----------------|-------------------|
| LAN Status | | | |
| IP Address | | | |
| FE80::21D::AAFF:FEA6:2568/64 (Link) | | | |
| TX Packets | RX Packets | TX Bytes | RX Bytes |
| 4 | 0 | 312 | 0 |
| WAN2 IPv6 Status | | | |
| Enable | Mode | Up Time | |
| Yes | Static IPv6 | 0:03:56 | |
| IP | | | Gateway IP |
| 2001:B010:7300:201:21D::AAFF:FEA6:256A/64 (Global) | | | --- |
| 2001:1111:2222:5555:21D::AAFF:FEA6:256A/64 (Global) | | | |
| FE80::21D::AAFF:FEA6:256A/64 (Link) | | | |
| TX Packets | RX Packets | TX Bytes | RX Bytes |
| 8 | 2 | 608 | 364 |

- **6in4 Static Tunnel**

Choose 6in4 Static Tunnel. Type remote endpoint IPv4 address, 6in4 IPv6 Address, LAN Routed Prefix and Tunnel TTL.

WAN >> Internet Access i

WAN 1

| PPPoE | Static or Dynamic IP | PPTP/L2TP | IPv6 |
|------------------------------|----------------------|----------------------------------|-------------------|
| Internet Access Mode | | | |
| Connection Type | | 6in4 Static Tunnel | |
| 6in4 Static Tunnel | | | |
| Remote Endpoint IPv4 Address | | <input type="text"/> | |
| 6in4 IPv6 Address | | <input type="text"/> | / 64 (default:64) |
| LAN Routed Prefix | | <input type="text"/> | / 64 (default:64) |
| Tunnel TTL | | <input type="text" value="255"/> | (default:255) |
| OK | | Cancel | |

Click **OK** and open **Online Status**. If the connection is successful, the physical connection will be shown as follows:

Online Status

Physical Connection System Uptime: 0day 0:4:16

| IPv4 | IPv6 |
|------------------------------------------------------|--------------------|
| LAN Status | |
| IP Address | |
| 2001:4DD0:FE00:83E4::21D::AAFF:FE83:11B4/64 (Global) | |
| FE80::21D:AAFF:FE83:11B4/64 (Link) | |
| TX Packets | RX Packets |
| 14 | 80 |
| TX Bytes | RX Bytes |
| 1244 | 6815 |
| WAN1 IPv6 Status | |
| Enable | Mode |
| Yes | 6in4 Static Tunnel |
| | Up Time |
| | 0:04:07 |
| IP | Gateway IP |
| 2001:4DD0:FF10:83E4::2131/64 (Global) | --- |
| FE80::C0A8:651D/128 (Link) | |
| TX Packets | RX Packets |
| 3 | 26 |
| TX Bytes | RX Bytes |
| 211 | 2302 |

- **6rd**

Choose 6rd. Type IPv4 Border Relay, IPv4 Mask Length, 6rd Prefix and 6rd Prefix Length.

WAN 1

| PPPoE | Static or Dynamic IP | PPTP/L2TP | IPv6 |
|-----------------------------|----------------------|----------------------------------------------------------------------------|------|
| Internet Access Mode | | | |
| Connection Type | | 6rd | |
| 6rd Settings | | | |
| 6rd Mode | | <input type="radio"/> Auto 6rd <input checked="" type="radio"/> Static 6rd | |
| Static 6rd Settings | | | |
| IPv4 Border Relay: | 192.168.101.111 | | |
| IPv4 Mask Length: | 0 | | |
| 6rd Prefix: | 2001:E41:: | | |
| 6rd Prefix Length: | 32 | | |
| OK | | Cancel | |

Click **OK** and open **Online Status**. If the connection is successful, the physical connection will be shown as follows:

Online Status

Physical Connection System Uptime: 0day 0:9:15

| IPv4 | | IPv6 | |
|----------------------------------------------------|-------------------|-------------------|-----------------|
| LAN Status | | | |
| IP Address | | | |
| 2001:E41:A865:1D00:21D:AAFF:FE83:11B4/64 (Global) | | | |
| FE80::21D:AAFF:FE83:11B4/64 (Link) | | | |
| TX Packets | RX Packets | TX Bytes | RX Bytes |
| 15 | 113 | 1354 | 18040 |
| WAN1 IPv6 Status | | | |
| Enable | Mode | Up Time | |
| Yes | 6rd | 0:09:06 | |
| IP | | Gateway IP | |
| 2001:E41:A865:1D01:21D:AAFF:FE83:11B5/128 (Global) | | --- | |
| FE80::C0A8:651D/128 (Link) | | | |
| TX Packets | RX Packets | TX Bytes | RX Bytes |
| 13 | 29 | 967 | 2620 |

II. Configuring the LAN Settings

After finished the WAN settings for IPv6, please configure the LAN settings to make the router's client getting the IPv6 address.

1. Access into the web user interface of Viogr2760. Open **LAN>> General Setup**. Click the **IPv6** button. Then, click **LAN1 IPv6 Setup** tab.

Note: Only the subnet of **LAN 1** supports IPv6 feature.

LAN >> General Setup

LAN 1 Ethernet TCP / IP and DHCP Setup LAN 1 IPv6 Setup

Router Advertisement Server

Enable Disable

Advertisement Lifetime Seconds (Range : 600 - 9000)

DHCPv6 Server Configuration

Enable Server Disable Server

Start IPv6 Address

End IPv6 Address

DNS Server IPv6 Address

Primary DNS Server

Secondary DNS Server

Static IPv6 Address configuration

IPv6 Address / Prefix Length

Current IPv6 Address Table

| Index | IPv6 Address/Prefix Length | Scope |
|-------|------------------------------|-------|
| 1 | FE80::21D:A AFF:FEA6:2568/64 | Link |

2. In the field of **Router Advertisement Server**, the default setting is **Enable**. The client's PC will ask router advertisement service for the Prefix of IPv6 address automatically, and generate an Interface ID by itself to compose a full and unique IPv6 address.
3. In the field of **HCPv6 Server Configuration**, when DHCPv6 service is enabled, you can assign available IPv6 address for the client manually.

Note: When both mechanisms are enabled, the client can determine which mechanism to be used (e.g., the default mechanism for Windows7 is Router Advertisement Server).

III. Confirming IPv6 Service Run Successfully

1. Make sure you have get the correct IPv6 IP address. Get into MS-DOS interface and type the command of “ipconfig”. Refer to the following figure.

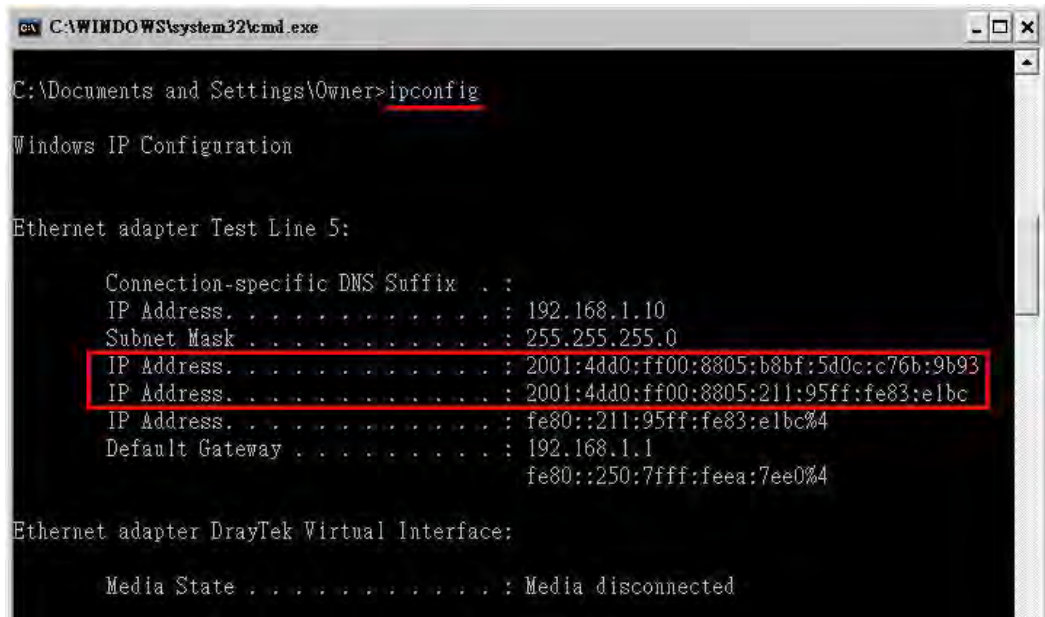

```
C:\WINDOWS\system32\cmd.exe
C:\Documents and Settings\Owner>ipconfig

Windows IP Configuration

Ethernet adapter Test Line 5:

    Connection-specific DNS Suffix . . : 
    IP Address. . . . . : 192.168.1.10
    Subnet Mask . . . . . : 255.255.255.0
    IP Address. . . . . : 2001:4dd0:ff00:8805:b8bf:5d0c:c76b:9b93
    IP Address. . . . . : 2001:4dd0:ff00:8805:211:95ff:fe83:e1bc
    IP Address. . . . . : fe80::211:95ff:fe83:e1bc%4
    Default Gateway . . . . . : 192.168.1.1
                                   fe80::250:7fff:feea:7ee0%4

Ethernet adapter DrayTek Virtual Interface:

    Media State . . . . . : Media disconnected
```

From the above figure we can see IPv6 IP address has been captured by the system.

2. Use the Ping command to ping any IPv6 address indicating an IPv6 website. For example, www.kame.net is a website supporting IPv4 IP and IPv6 IP services. Its IPv6 address is seen with a format of 2001:200:dff:fff1:216:3eff:feb1:44d7.

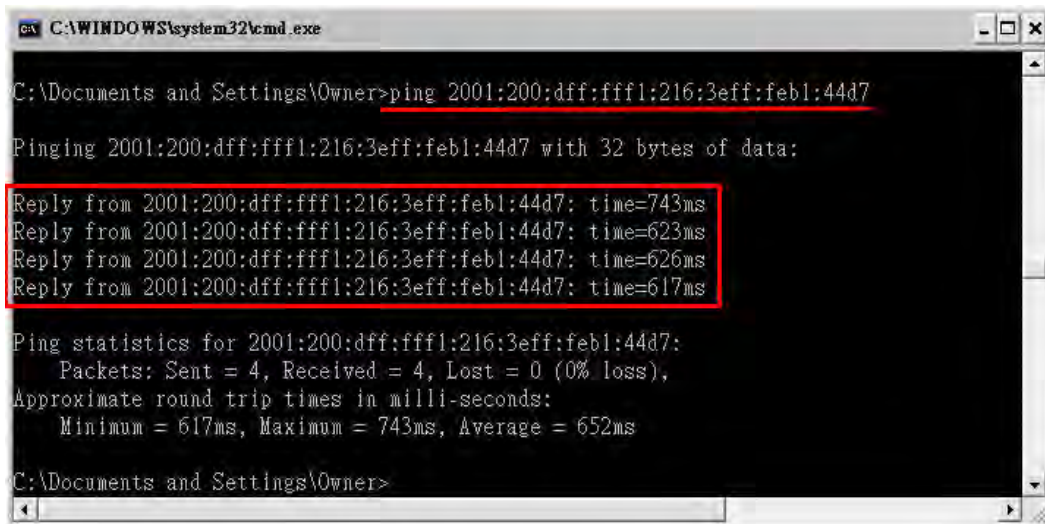

```
C:\WINDOWS\system32\cmd.exe
C:\Documents and Settings\Owner>ping 2001:200:dff:fff1:216:3eff:feb1:44d7

Pinging 2001:200:dff:fff1:216:3eff:feb1:44d7 with 32 bytes of data:

Reply from 2001:200:dff:fff1:216:3eff:feb1:44d7: time=743ms
Reply from 2001:200:dff:fff1:216:3eff:feb1:44d7: time=623ms
Reply from 2001:200:dff:fff1:216:3eff:feb1:44d7: time=626ms
Reply from 2001:200:dff:fff1:216:3eff:feb1:44d7: time=617ms

Ping statistics for 2001:200:dff:fff1:216:3eff:feb1:44d7:
    Packets: Sent = 4, Received = 4, Lost = 0 (0% loss),
    Approximate round trip times in milli-seconds:
        Minimum = 617ms, Maximum = 743ms, Average = 652ms

C:\Documents and Settings\Owner>
```

After getting the above message, it means the IPv6 service has been activated successfully.

3. Connect to the website for IPv6. Open a web browser and type an URL of IPv6, e.g., www.kame.net. If your computer accesses into the website by using IPv6 address, you may see a turtle dancing on the screen. If not, only a steady turtle will be seen.



If you can see a turtle dancing on the screen, that means IPv6 service is ready for you to access and utilize.

4.2 How can I get the files from USB storage device connecting to Vigor router?

Files on USB storage device can be reviewed by opening **USB Application>>File Explorer**. If it is necessary for you to delete, copy files on the device or write, paste files to the device, it must be done through FTP server.

You will need to setup USB FTP first. We would like to give brief instructions on USB FTP setup here.

1. Plug the USB device to the USB port on the router. Make sure **Disk Connected** appears on the **Connection Status** as the figure shown below:

USB Application >> USB Disk Status

USB Mass Storage Device Status

| | | |
|-----------------------|----------------|---------------------|
| Connection Status | Disk Connected | Disconnect USB Disk |
| Write Protect Status: | No | |
| Disk Capacity: | 2009 MB | |

USB Disk Users Connected | Refresh |

| Index | Service | IP Address(Port) | Username |
|-------|---------|------------------|----------|
|-------|---------|------------------|----------|

Note: If the write protect switch of USB disk is turned on, the USB disk is in READ-ONLY mode. No data can be written to it.

2. Setup a user account for the FTP service by using **USB Application >>USB User Management**. Click **Enable** to enable FTP account. Here we add a new account "user1" and assign authorities "Read", "Write" and "List" to it.

USB Application >> USB User Management

Profile Index: 1

| | |
|--------------------|--------------------------------------------------------------------------------------------------------------------|
| FTP | <input checked="" type="radio"/> Enable <input type="radio"/> Disable |
| Username | <input type="text" value="user1"/> |
| Password | <input type="password"/> (Maximum 11 Characters) |
| Confirm Password | <input type="password"/> |
| Home Folder | <input type="text"/>  |
| Access Rule | |
| File | <input checked="" type="checkbox"/> Read <input checked="" type="checkbox"/> Write <input type="checkbox"/> Delete |
| Directory | <input checked="" type="checkbox"/> List <input type="checkbox"/> Create <input type="checkbox"/> Remove |

Note: The folder name can only contain the following characters: A-Z a-z 0-9 \$ % ' - _ @ ~ ` ! () / and space.

3. Click **OK** to save the configuration.

- Make sure the FTP service is running properly. Please open a browser and type ftp://192.168.1.1. Use the account "user1" to login.

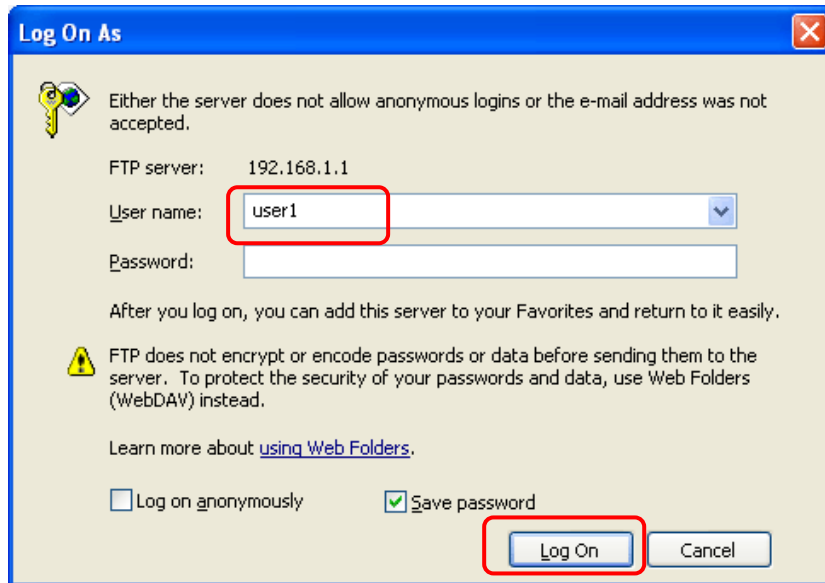

- When the following screen appears, it means the FTP service is running properly.

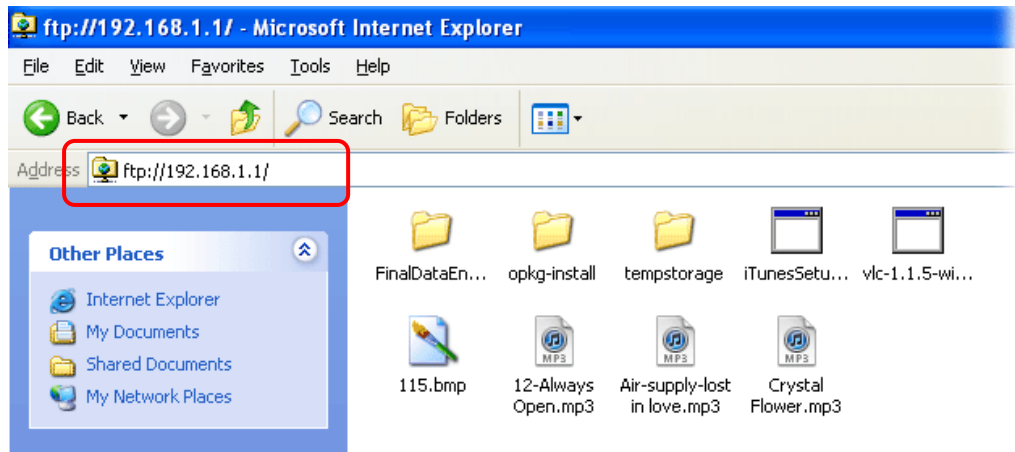

- Return to **USB Application >> USB Disk Status**. The information for FTP server will be shown as below.

USB Application >> USB Disk Status

USB Mass Storage Device Status

Connection Status: **Disk Connected** Disconnect USB Disk

Write Protect Status: **No**

Disk Capacity: 2009 MB

USB Disk Users Connected Refresh

| Index | Service | IP Address(Port) | Username | Drop |
|-------|---------|--------------------|----------|------|
| 1. | FTP | 192.168.1.10(1963) | user1 | Drop |

Now, users in LAN of Vigor2710 can access into the USB storage device by typing ftp://192.168.1.1 on any browser. They can add or remove files / directories, depending on the Access Rule for FTP account settings in **USB Application >>USB User Management**.

4.3 How to Build a LAN-to-LAN VPN Between Remote Office and Headquarter via IPsec Tunnel (Main Mode)



Configuration of Vigor Router (e.g. Vigor 2860) at Head Office

1. Log into the web user interface of Vigor router.
2. Open **VPN and Remote Access**>>**LAN to LAN** to create a LAN-to-LAN profile. The following settings are for a permanent VPN connection.

VPN and Remote Access >> LAN to LAN



LAN-to-LAN Profiles:

| Set to Factory Default |

| Index | Name | Active | Status | Index | Name | Active | Status |
|-----------|------|--------------------------|--------|------------|------|--------------------------|--------|
| <u>1.</u> | ??? | <input type="checkbox"/> | --- | <u>17.</u> | ??? | <input type="checkbox"/> | --- |
| <u>2.</u> | ??? | <input type="checkbox"/> | --- | <u>18.</u> | ??? | <input type="checkbox"/> | --- |
| <u>3.</u> | ??? | <input type="checkbox"/> | --- | <u>19.</u> | ??? | <input type="checkbox"/> | --- |
| <u>4.</u> | ??? | <input type="checkbox"/> | --- | <u>20.</u> | ??? | <input type="checkbox"/> | --- |
| <u>5.</u> | ??? | <input type="checkbox"/> | --- | <u>21.</u> | ??? | <input type="checkbox"/> | --- |

3. Click any index number to open the configuration page. Type a name which is easy for identification for such profile (in this case, type *VPN Server*), and check the box of **Enable This Profile**. For Vigor router will be set as a **server**, the call direction shall be set as **Dial-in** and set 0 as **Idle Timeout**.

VPN and Remote Access >> LAN to LAN

Profile Index : 1

1. Common Settings

| | |
|-------------------------------------------------------------------------------------------------------------------------------------|-------------------------------------------------------------------------------------------------------------------|
| Profile Name <input type="text" value="VPN Server"/> | Call Direction <input type="radio"/> Both <input type="radio"/> Dial-Out <input checked="" type="radio"/> Dial-in |
| <input checked="" type="checkbox"/> Enable this profile | <input type="checkbox"/> Always on |
| VPN Dial-Out Through <input type="text" value="WAN1 First"/> | Idle Timeout <input type="text" value="0"/> second(s) |
| Netbios Naming Packet <input checked="" type="radio"/> Pass <input type="radio"/> Block | <input type="checkbox"/> Enable PING to keep alive |
| Multicast via VPN <input checked="" type="radio"/> Pass <input type="radio"/> Block (for some IGMP, IP-Camera, DHCP Relay..etc.) | PING to the IP <input type="text"/> |

2. Dial-Out Settings

- Now navigate to the next section, **Dial-In Settings** to check PPTP, IPsec Tunnel and L2TP boxes. Check the box of **Specify Remote...** and type the **Peer VPN Server IP** (e.g., 218.242.130.19 in this case). Press the **IKE Pre-Shared Key** button to set the **PSK**; and select **Medium (AH)** or **High (ESP)** as the security method.

3. Dial-In Settings

| | |
|---------------------------------------------------------------------------------------------------------------------------------------------------------------------------------------------------------------------------------------------------------------------------------------------------------------------------------------------------------------------------------------------------|--------------------------------------------------------------------------------------------------------------------------------------------------------------------------------------------------------------------------------------------------------------------------------------------------------------------------------------------------------------------------------------------------------------------------------------------------------------------------------------------------------------------------------------------------------------------------------------------------------------------------------------------------------------------------------------------------------------------------------------------------------------------------------------------------------------------------------------------------------------------------------------------------------------|
| <p>Allowed Dial-In Type</p> <p><input checked="" type="checkbox"/> PPTP</p> <p><input checked="" type="checkbox"/> IPsec Tunnel</p> <p><input checked="" type="checkbox"/> L2TP with IPsec Policy None</p> <hr/> <p><input checked="" type="checkbox"/> Specify Remote VPN Gateway</p> <p>Peer VPN Server IP</p> <p>218.242.130.19</p> <p>or Peer ID <input type="text"/></p> | <p>Username <input data-bbox="1161 389 1385 421" type="text" value="???"/></p> <p>Password <input data-bbox="1161 434 1385 465" type="password"/></p> <p>VJ Compression <input type="radio"/> On <input checked="" type="radio"/> Off</p> <hr/> <p>IKE Authentication Method</p> <p><input checked="" type="checkbox"/> Pre-Shared Key</p> <p>IKE Pre-Shared Key <input data-bbox="1161 591 1385 622" type="text"/></p> <p><input checked="" type="checkbox"/> Digital Signature(X.509)</p> <p>None</p> <p>Local ID</p> <p><input checked="" type="radio"/> Alternative Subject Name First</p> <p><input type="radio"/> Subject Name First</p> <hr/> <p>IPsec Security Method</p> <p><input checked="" type="checkbox"/> Medium(AH)</p> <p>High(ESP) <input checked="" type="checkbox"/> DES <input checked="" type="checkbox"/> 3DES <input checked="" type="checkbox"/> AES</p> |
|---------------------------------------------------------------------------------------------------------------------------------------------------------------------------------------------------------------------------------------------------------------------------------------------------------------------------------------------------------------------------------------------------|--------------------------------------------------------------------------------------------------------------------------------------------------------------------------------------------------------------------------------------------------------------------------------------------------------------------------------------------------------------------------------------------------------------------------------------------------------------------------------------------------------------------------------------------------------------------------------------------------------------------------------------------------------------------------------------------------------------------------------------------------------------------------------------------------------------------------------------------------------------------------------------------------------------|

4. Gre over IPsec Settings

- Continue to navigate to the **TCP/IP Network Settings** for setting the LAN IP for remote side.

5. TCP/IP Network Settings

| | |
|----------------------------------------------------------------------------------------------------------------------------------------------------------------------------------------------------------------------------------------------------------------------------------------------------------------------------------------------------------------------------------------------------------------------------------------------|------------------------------------------------------------------------------------------------------------------------------------------------------------------------------------------------------------------------------------------------|
| <p>My WAN IP <input type="text" value="0.0.0.0"/></p> <p>Remote Gateway IP <input type="text" value="0.0.0.0"/></p> <p>Remote Network IP <input type="text" value="192.168.1.0"/></p> <p>Remote Network Mask <input type="text" value="255.255.255.0"/></p> <p>Local Network IP <input type="text" value="192.168.1.9"/></p> <p>Local Network Mask <input type="text" value="255.255.255.0"/></p> <p><input type="button" value="More"/></p> | <p>RIP Direction Disable</p> <p>From first subnet to remote network, you have to do</p> <p>Route</p> <hr/> <p><input type="checkbox"/> Change default route to this VPN tunnel (Only single WAN supports this)</p> |
|----------------------------------------------------------------------------------------------------------------------------------------------------------------------------------------------------------------------------------------------------------------------------------------------------------------------------------------------------------------------------------------------------------------------------------------------|------------------------------------------------------------------------------------------------------------------------------------------------------------------------------------------------------------------------------------------------|

- Click **OK** to save the settings.

- Open **VPN and Remote Access>>Connection Management** to check the dial-in connection status (from branch office).

VPN and Remote Access >> Connection Management

Dial-out Tool Refresh Seconds : 5

(V2920) 172.16.2.145

VPN Connection Status
Current Page: 1 Page No. >>

| VPN | Type | Remote IP | Virtual Network | Tx Pkts | Tx Rate (Bps) | Rx Pkts | Rx Rate (Bps) | UpTime |
|---------------------|-------------------------------|----------------|-----------------|---------|---------------|---------|---------------|---------------------------------------------|
| 1 (VPN Server) | IPSec Tunnel DES-SHA1 Auth | 218.242.130.19 | 192.168.1.0/24 | 353 | 3 | 291 | 3 | 0:13:58 <input type="button" value="Drop"/> |

xxxxxxx : Data is encrypted.
xxxxxxx : Data isn't encrypted.

Configuration on Vigor Router (e.g. Vigor 2760) for Branch Office

- Log into the web user interface of Vigor router.
- Open **VPN and Remote Access>>LAN to LAN** to create a LAN-to-LAN profile. The following settings are for a permanent VPN connection.

VPN and Remote Access >> LAN to LAN 

LAN-to-LAN Profiles: | [Set to Factory Default](#) |

| Index | Name | Active | Status | Index | Name | Active | Status |
|-------|------|--------------------------|--------|-------|------|--------------------------|--------|
| 1. | ??? | <input type="checkbox"/> | --- | 17. | ??? | <input type="checkbox"/> | --- |
| 2. | ??? | <input type="checkbox"/> | --- | 18. | ??? | <input type="checkbox"/> | --- |
| 3. | ??? | <input type="checkbox"/> | --- | 19. | ??? | <input type="checkbox"/> | --- |
| 4. | ??? | <input type="checkbox"/> | --- | 20. | ??? | <input type="checkbox"/> | --- |
| 5. | ??? | <input type="checkbox"/> | --- | 21. | ??? | <input type="checkbox"/> | --- |

- Click any index number to open the configuration page. Type a name which is easy for identification for such profile (in this case, type *VPN Client*), and check the box of **Enable This Profile**. Check the box of **Always on** for a permanent VPN connection.

VPN and Remote Access >> LAN to LAN

Profile Index : 1

1. Common Settings

| | |
|-----------------------------------------------------------------------------------------|--------------------------------------------------------|
| Profile Name <input type="text" value="VPN Client"/> | <input checked="" type="checkbox"/> Always on |
| <input checked="" type="checkbox"/> Enable this profile | Idle Timeout <input type="text" value="-1"/> second(s) |
| VPN Dial-Out Through <input type="text" value="WAN1 First"/> | <input type="checkbox"/> Enable PING to keep alive |
| Netbios Naming Packet <input checked="" type="radio"/> Pass <input type="radio"/> Block | PING to the IP <input type="text"/> |
| Multicast via VPN <input checked="" type="radio"/> Pass <input type="radio"/> Block | |
| (for some IGMP,IP-Camera,DHCP Relay...etc.) | |

2. Dial-Out Settings

- Now navigate to the next section, **Dial-Out Settings** to select the **IPsec Tunnel** service and type the remote server IP/host name (e.g., 218.242.133.91, in this case). Press the **IKE Pre-Shared Key** button to set the **PSK**; and select **Medium (AH)** or **High (ESP)** as the security method.

2. Dial-Out Settings

| | |
|--------------------------------------------------------------------------------------------------------------------------------------------------------------------------------------------------------|-----------------------------------------------------------------------------------------------------------------------------------------------------------------------------------------------------------------------------------------------------------------------------------------------------------------------------------------------------------------------------------------------------------------------------------------------------------------------------------------|
| <p>Type of Server I am calling</p> <p><input type="radio"/> PPTP</p> <p><input checked="" type="radio"/> IPsec Tunnel</p> <p><input type="radio"/> L2TP with IPsec Policy None</p> | <p>Username <input data-bbox="1161 376 1378 407" type="text" value="???"/></p> <p>Password <input data-bbox="1161 421 1366 452" type="password"/></p> <p>PPP Authentication PAP/CHAP</p> <p>VJ Compression <input type="radio"/> On <input checked="" type="radio"/> Off</p> |
| <p>Server IP/Host Name for VPN. (such as draytek.com or 123.45.67.89)</p> <p><input data-bbox="402 600 705 631" type="text" value="218.242.133.91"/></p> | <p>IKE Authentication Method</p> <p><input checked="" type="radio"/> Pre-Shared Key</p> <p><input data-bbox="906 622 1145 654" type="button" value="IKE Pre-Shared Key"/> <input data-bbox="1161 622 1366 654" type="password" value="....."/></p> <p><input type="radio"/> Digital Signature(X.509)</p> <p>Peer ID None</p> <p>Local ID</p> <p><input checked="" type="radio"/> Alternative Subject Name First</p> <p><input type="radio"/> Subject Name First</p> |
| | <p>IPsec Security Method</p> <p><input type="radio"/> Medium(AH)</p> <p><input checked="" type="radio"/> High(ESP) 3DES with Authentication</p> <p><input data-bbox="906 945 1008 976" type="button" value="Advanced"/></p> |
| <p>Index(1-15) in <u>Schedule</u> Setup:</p> <p><input type="text"/> , <input type="text"/> , <input type="text"/> , <input type="text"/></p> | |

- Continue to navigate to the **TCP/IP Network Settings** for setting the LAN IP for the remote side.

4. Gre over IPsec Settings

Enable IPsec Dial-Out function GRE over IPsec

Logical Traffic My GRE IP Peer GRE IP

5. TCP/IP Network Settings

| | |
|---------------------------------------------------------------------------------------------------------------------------------------------------------------------------------------------------------------------------------------------------------------------------------------------------------------------------------------------------------------------------------------------------------------------------------------------------------------------------------------------------------------------------------------------------------------------------------------------------------------------------------------------------------------------------------------------------------------------------------------|--------------------------------------------------------------------------------------------------------------------------------------------------------------------------------------------------------------------------------------------------------------------------------------------|
| <p>My WAN IP <input data-bbox="657 1339 874 1370" type="text" value="0.0.0.0"/></p> <p>Remote Gateway IP <input data-bbox="657 1384 874 1415" type="text" value="0.0.0.0"/></p> <p><input checked="" type="checkbox"/> Remote Network IP <input data-bbox="657 1429 874 1460" type="text" value="172.17.1.0"/></p> <p><input checked="" type="checkbox"/> Remote Network Mask <input data-bbox="657 1473 874 1505" type="text" value="255.255.255.0"/></p> <p>Local Network IP <input data-bbox="657 1518 874 1550" type="text" value="192.168.1.9"/></p> <p>Local Network Mask <input data-bbox="657 1563 874 1594" type="text" value="255.255.255.0"/></p> <p><input data-bbox="657 1608 730 1639" type="button" value="More"/></p> | <p>RIP Direction Disable</p> <p>From first subnet to remote network, you have to do</p> <p><input data-bbox="1161 1429 1248 1460" type="button" value="Route"/></p> <p><input type="checkbox"/> Change default route to this VPN tunnel (Only single WAN supports this)</p> |
|---------------------------------------------------------------------------------------------------------------------------------------------------------------------------------------------------------------------------------------------------------------------------------------------------------------------------------------------------------------------------------------------------------------------------------------------------------------------------------------------------------------------------------------------------------------------------------------------------------------------------------------------------------------------------------------------------------------------------------------|--------------------------------------------------------------------------------------------------------------------------------------------------------------------------------------------------------------------------------------------------------------------------------------------|

- Click **OK** to save the settings.

- Open **VPN and Remote Access>>Connection Management** to check the dial-in connection status (from head office).

VPN and Remote Access >> Connection Management

Dial-out Tool Refresh Seconds : 5

(V2920) 172.16.2.145

VPN Connection Status

Current Page: 1 Page No.

| VPN | Type | Remote IP | Virtual Network | Tx Pkts | Tx Rate (Bps) | Rx Pkts | Rx Rate (Bps) | UpTime |
|---------------------|-------------------------------|----------------|-----------------|---------|---------------|---------|---------------|--------------------------------------------|
| 1 (VPH Client) | IPSec Tunnel DES-SHA1 Auth | 218.242.133.91 | 172.17.1.0/24 | 8 | 3 | 132 | 36 | 0:6:41 <input type="button" value="Drop"/> |

xxxxxxx : Data is encrypted.
xxxxxxx : Data isn't encrypted.

4.4 How to Optimize the Bandwidth through QoS Technology

Have you ever gotten any problems in uploading/downloading files (Voice, video or email/data only) with the narrow/districted bandwidth you may share from the common Internet connection line? The advanced bandwidth management technology-QoS (Quality of Service) helps you to well allocate the bandwidth upon your demand of Voice, Video, or Data transferring. Let's see how to get the optimum bandwidth per your request by using DrayTek Vigor router as below.

Scenario: The Internet connection you got from ISP line is 2MB/512Kb. There are VoIP telephony network, IPTV set top box and data server at your home. Assume you want to allocate 30% of the bandwidth you got to VoIP demand, 50% for IPTV, 15% for mail/data, 5% for others. Let's see how easily it is to do the setting as below:

- Open **Bandwidth Management>> Quality of Service**.

Bandwidth Management

- Sessions Limit
- Bandwidth Limit
- Quality of Service
- APP QoS

- You will get the following page. Click the **Edit** link for **Class 1**.

Bandwidth Management >> Quality of Service

General Setup | Set to Factory Default |

| Index | Status | Bandwidth | Direction | Class 1 | Class 2 | Class 3 | Others | UDP Bandwidth Control | Online Statistics |
|-------|---------|-----------------------|-----------|---------|---------|---------|--------|-----------------------|---------------------------------------------|
| WAN1 | Disable | --Kbps/--Kbps | | 25% | 25% | 25% | 25% | Inactive | Status <input type="button" value="Setup"/> |
| WAN2 | Disable | 100000Kbps/100000Kbps | | 25% | 25% | 25% | 25% | Inactive | Status <input type="button" value="Setup"/> |
| WAN3 | Disable | 100000Kbps/100000Kbps | | 25% | 25% | 25% | 25% | Inactive | Status <input type="button" value="Setup"/> |

Class Rule

| Index | Name | Rule | Service Type |
|---------|------|-------------------------------------|-------------------------------------|
| Class 1 | | <input type="button" value="Edit"/> | |
| Class 2 | | <input type="button" value="Edit"/> | <input type="button" value="Edit"/> |
| Class 3 | | <input type="button" value="Edit"/> | |

Enable the First Priority for VoIP SIP/RTP:

SIP UDP Port: (Default: 5060)

- In the following page, type a name (e.g., VoIP) for such class and click **Add**.

Bandwidth Management >> Quality of Service

Class Index #1

Name Tag packets as: Default

| NO | Status | Local Address | Remote Address | DiffServ CodePoint | Service Type |
|----|--------|---------------|----------------|--------------------|--------------|
| 1 | Empty | - | - | - | - |

- Check the box of **ACT**. Click **Edit** to specify the local address.

Bandwidth Management >> Quality of Service

Rule Edit

ACT

Ethernet Type IPv4 IPv6

Local Address

Remote Address

DiffServ CodePoint

Service Type

Note: Please choose/setup the **Service Type** first.

- In the pop-up window, choose **Range Address** as the **Address Type** and type the start IP address and end IP address in relational fields. Click **OK** to save the settings and exit the window.

Ethernet Type: IPv4

Address Type

Start IP Address

End IP Address

Subnet Mask

- Click **OK** again to save the settings.

Bandwidth Management >> Quality of Service

Rule Edit

ACT

Ethernet Type IPv4 IPv6

Local Address

Remote Address

DiffServ CodePoint

Service Type

Note: Please choose/setup the **Service Type** first.

7. The class rule for VoIP has been set. Click **OK** to return to previous page.

Bandwidth Management >> Quality of Service

Class Index #1
 Name Tag packets as:

| NO | Status | Local Address | Remote Address | DiffServ CodePoint | Service Type |
|-------------------------|--------|-----------------------------|----------------|--------------------|--------------|
| 1 <input type="radio"/> | Active | 172.16.1.240 ~ 172.16.1.241 | Any | ANY | ANY |

8. Do the same steps to add class rules for IPTV and Data/Email with IP addresses as shown below.

Bandwidth Management >> Quality of Service

Class Index #2
 Name Tag packets as:

| NO | Status | Local Address | Remote Address | DiffServ CodePoint | Service Type |
|-------------------------|--------|-----------------------------|----------------|--------------------|--------------|
| 1 <input type="radio"/> | Active | 172.16.1.242 ~ 172.16.1.249 | Any | ANY | ANY |

and

Bandwidth Management >> Quality of Service

Class Index #3
 Name Tag packets as:

| NO | Status | Local Address | Remote Address | DiffServ CodePoint | Service Type |
|-------------------------|--------|---------------|----------------|--------------------|--------------|
| 1 <input type="radio"/> | Active | Any | Any | IP precedence 2 | ANY |

9. Assuming you get 2MB/512Kb Internet line. You can click the **Setup** link of WAN1 to set up the bandwidth for different groups among VoIP, IPTV and Data/Email.

Bandwidth Management >> Quality of Service

General Setup | [Set to Factory Default](#)

| Index | Status | Bandwidth | Direction | Class 1 | Class 2 | Class 3 | Others | UDP Bandwidth Control | Online Statistics |
|-------|---------|-----------------------|-----------|---------|---------|---------|--------|-----------------------|------------------------------|
| WAN1 | Enable | --Kbps/--Kbps | Outbound | 30% | 50% | 15% | 5% | Active | Status Setup |
| WAN2 | Disable | 100000Kbps/100000Kbps | | 25% | 25% | 25% | 25% | Inactive | Status Setup |
| WAN3 | Disable | 100000Kbps/100000Kbps | | 25% | 25% | 25% | 25% | Inactive | Status Setup |

Class Rule

| Index | Name | Rule | Service Type |
|---------|------------|----------------------|----------------------|
| Class 1 | VoIP | Edit | Edit |
| Class 2 | IPTV | Edit | |
| Class 3 | Data/Email | Edit | |

10. In the Setup page, check the box of **Enable the QoS Control**. Type 30, 50 and 15 in the boxes for VoIP, IPTV and Data/Email respectively. Check the box of **Enable UDP Bandwidth Control**.

Bandwidth Management >> Quality of Service

WAN1 General Setup

Enable the QoS Control OUT

| Index | Class Name | Reserved Bandwidth Ratio |
|---------|------------|--------------------------|
| Class 1 | VoIP | 30 % |
| Class 2 | IPTV | 50 % |
| Class 3 | Data/Email | 15 % |
| | Others | 5 % |

Enable UDP Bandwidth Control Limited_bandwidth Ratio %

Outbound TCP ACK Prioritize

11. Click **OK** to save the settings. The class rules for WAN1 are defined as shown below.

Bandwidth Management >> Quality of Service

General Setup | [Set to Factory Default](#)

| Index | Status | Bandwidth | Direction | Class 1 | Class 2 | Class 3 | Others | UDP Bandwidth Control | Online Statistics |
|-------|---------|-----------------------|-----------|---------|---------|---------|--------|-----------------------|------------------------------|
| WAN1 | Enable | --Kbps/--Kbps | Outbound | 30% | 50% | 15% | 5% | Active | Status Setup |
| WAN2 | Disable | 100000Kbps/100000Kbps | | 25% | 25% | 25% | 25% | Inactive | Status Setup |
| WAN3 | Disable | 100000Kbps/100000Kbps | | 25% | 25% | 25% | 25% | Inactive | Status Setup |

Class Rule

| Index | Name | Rule | Service Type |
|---------|--------|----------------------|----------------------|
| Class 1 | E-mail | Edit | Edit |
| Class 2 | HTTPS | Edit | |
| Class 3 | | Edit | |

4.5 QoS Setting Example

Assume a teleworker sometimes works at home and takes care of children. When working time, he would use Vigor router at home to connect to the server in the headquarter office downtown via either HTTPS or V PN to check email and access internal database. Meanwhile, children may chat on Skype in the restroom.

1. Go to **Bandwidth Management>>Quality of Service**.

Bandwidth Management >> Quality of Service

General Setup | [Set to Factory Default](#) |

| Index | Status | Bandwidth | Direction | Class 1 | Class 2 | Class 3 | Others | UDP Bandwidth Control | Online Statistics | |
|-------|---------|-----------------------|-----------|---------|---------|---------|--------|-----------------------|-------------------|-----------------------|
| WAN1 | Disable | --Kbps/--Kbps | | 25% | 25% | 25% | 25% | Inactive | Status | Setup |
| WAN2 | Disable | 100000Kbps/100000Kbps | | 25% | 25% | 25% | 25% | Inactive | Status | Setup |
| WAN3 | Disable | 100000Kbps/100000Kbps | | 25% | 25% | 25% | 25% | Inactive | Status | Setup |

Class Rule

| Index | Name | Rule | Service Type |
|---------|------|----------------------|----------------------|
| Class 1 | | Edit | Edit |
| Class 2 | | Edit | |
| Class 3 | | Edit | |

Enable the First Priority for VoIP SIP/RTP:
 SIP UDP Port: (Default: 5060)

2. Click **Setup** link of WAN(1/2/3). Make sure the QoS Control on the left corner is checked. And select **BOTH** in **Direction**.

Bandwidth Management >> Quality of Service

WAN2 General Setup

Enable the QoS Control

WAN Inbound Bandwidth Kbps

WAN Outbound Bandwidth Kbps

3. Set Inbound/Outbound bandwidth.

Bandwidth Management >> Quality of Service

WAN2 General Setup

Enable the QoS Control

WAN Inbound Bandwidth Kbps

WAN Outbound Bandwidth Kbps

| Index | Class Name | Reserved Bandwidth Ratio |
|---------|------------|-----------------------------------|
| Class 1 | VoIP | <input type="text" value="25"/> % |

Note: The rate of outbound/inbound must be smaller than the real bandwidth to ensure correct calculation of QoS. It is suggested to set the bandwidth value for inbound/outbound as 80% - 85% of physical network speed provided by ISP to maximize the QoS performance.

- Return to previous page. Enter the Name of Index Class 1 by clicking **Edit** link. Type the name “E-mail” for Class 1. Click **OK** to save the settings.

Bandwidth Management >> Quality of Service

Class Index #1

Name Tag packets as:

| NO | Status | Local Address | Remote Address | DiffServ CodePoint | Service Type |
|----|--------|---------------|----------------|--------------------|--------------|
| 1 | Active | Any | Any | ANY | ANY |

- Click the **Setup** link for WAN2. The user can set reserved bandwidth (e.g., 25%) for **E-mail** using protocol POP3 and SMTP. Click **OK** to save the settings.

Bandwidth Management >> Quality of Service

WAN2 General Setup

Enable the QoS Control

WAN Inbound Bandwidth Kbps

WAN Outbound Bandwidth Kbps

| Index | Class Name | Reserved bandwidth Ratio |
|---------|------------|-----------------------------------|
| Class 1 | E-mail | <input type="text" value="25"/> % |
| Class 2 | | <input type="text" value="25"/> % |
| Class 3 | | <input type="text" value="25"/> % |
| | Others | <input type="text" value="25"/> % |

Enable UDP Bandwidth Control Limited_bandwidth Ratio %

Outbound TCP ACK Prioritize

- Return to previous page. Enter the Name of Index Class 2 by clicking **Edit** link. In this index, the user will set reserved bandwidth for **HTTPS**. And click **OK**.

Bandwidth Management >> Quality of Service

Class Index #2

Name Tag packets as:

| NO | Status | Local Address | Remote Address | DiffServ CodePoint | Service Type |
|----|--------|-----------------------------|----------------|--------------------|--------------|
| 1 | Active | 172.16.1.242 ~ 172.16.1.249 | Any | ANY | ANY |

- Click **Setup** link for WAN2.

Bandwidth Management >> Quality of Service

General Setup | Set to Factory Default |

| Index | Status | Bandwidth | Direction | Class 1 | Class 2 | Class 3 | Others | UDP Bandwidth Control | Online Statistics | |
|-------|---------|-----------------------|-----------|---------|---------|---------|--------|-----------------------|-------------------|-------|
| WAN1 | Enable | --Kbps/--Kbps | Both | 25% | 25% | 25% | 25% | Inactive | Status | Setup |
| WAN2 | Disable | 100000Kbps/100000Kbps | | 25% | 25% | 25% | 25% | Inactive | Status | Setup |
| WAN3 | Disable | 100000Kbps/100000Kbps | | 25% | 25% | 25% | 25% | Inactive | Status | Setup |

Class Rule

| Index | Name | Rule | Service Type |
|---------|--------|------|--------------|
| Class 1 | E-mail | Edit | |
| Class 2 | HTTPS | Edit | Edit |
| Class 3 | | Edit | |

Enable the First Priority for VoIP SIP/RTP:

SIP UDP Port: (Default: 5060)

- Check **Enable UDP Bandwidth Control** on the bottom to prevent enormous UDP traffic influent other application. Click **OK**.

Bandwidth Management >> Quality of Service

WAN2 General Setup

Enable the QoS Control BOTH

WAN Inbound Bandwidth Kbps

WAN Outbound Bandwidth Kbps

| Index | Class Name | Reserved Bandwidth Ratio |
|---------|------------|-----------------------------------|
| Class 1 | E-mail | <input type="text" value="25"/> % |
| Class 2 | HTTPS | <input type="text" value="25"/> % |
| Class 3 | | <input type="text" value="25"/> % |
| | Others | <input type="text" value="25"/> % |

Enable UDP Bandwidth Control Limited Bandwidth Ratio %

Outbound TCP ACK Prioritize

- If the worker has connected to the headquarter using host to host VPN tunnel. (Please refer to Chapter 3 VPN for detail instruction), he may set up an index for it. Enter the

Class Name of Index 3. In this index, he will set reserved bandwidth for 1 VPN tunnel.

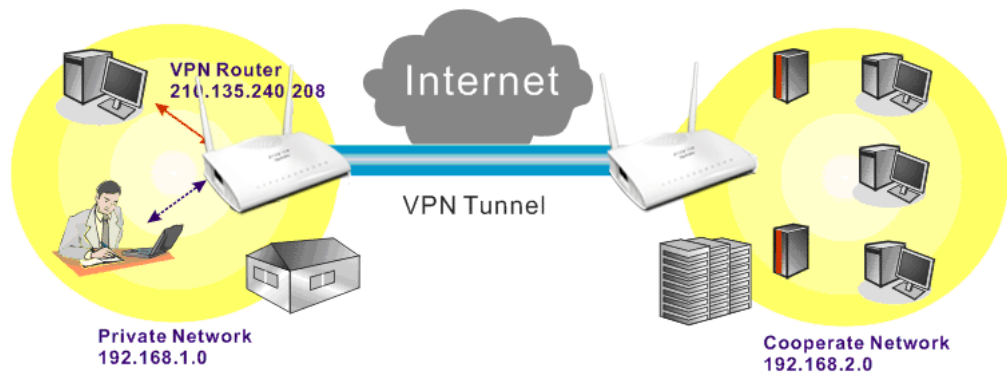

- Click **Edit** for Class 3 to open a new window. In this index, the user will set reserved bandwidth for **VPN**.

Bandwidth Management >> Quality of Service

Class Index #3

Name Tag packets as:

| NO | Status | Local Address | Remote Address | DiffServ CodePoint | Service Type |
|----|--------|---------------|----------------|--------------------|--------------|
| 1 | Empty | - | - | - | - |

- Click **Add** to open the following window. Check the **ACT** box, first.

Bandwidth Management >> Quality of Service

Rule Edit

ACT

Ethernet Type IPv4 IPv6

Local Address

Remote Address

DiffServ CodePoint

Service Type

Note: Please choose/setup the Service Type first.

12. Then click **Edit** of **Local Address** to set a worker's subnet address. Click **Edit** of **Remote Address** to set headquarter's IP address. Leave other fields and click **OK**.

Bandwidth Management >> Quality of Service

Rule Edit

| | |
|-----------------------------------------------------------------|--------------------------------------------------------------------------------|
| <input checked="" type="checkbox"/> ACT | |
| Ethernet Type | <input checked="" type="radio"/> IPv4 <input type="radio"/> IPv6 |
| Local Address | <input type="text" value="192.168.1.0"/> <input type="button" value="Edit"/> |
| Remote Address | <input type="text" value="192.168.2.0"/> <input type="button" value="Edit"/> |
| DiffServ CodePoint | <input type="text" value="ANY"/> <input type="button" value="v"/> |
| Service Type | <input type="text" value="---Predefined---"/> <input type="button" value="v"/> |
| Note: Please choose/setup the Service Type first. | |

4.6 How to Send a Notification to Specified Phone Number via SMS Service in WAN Disconnection

Follow the steps listed below:

1. Log into the web user interface of Vigor router.
2. Configure relational objects first. Open **Object Settings>>SMS/Mail Server Object** to get the following page.

Object Settings >> SMS / Mail Service Object

| SMS Provider | Mail Server | | Set to Factory Default |
|--------------|--------------|--------------------|----------------------------------------|
| Index | Profile Name | SMS Provider | |
| 1. | | kotsms.com.tw (TW) | |
| 2. | | kotsms.com.tw (TW) | |
| 3. | | kotsms.com.tw (TW) | |
| 4. | | kotsms.com.tw (TW) | |
| 5. | | kotsms.com.tw (TW) | |
| 6. | | kotsms.com.tw (TW) | |
| 7. | | kotsms.com.tw (TW) | |
| 8. | | kotsms.com.tw (TW) | |
| 9. | Custom 1 | | |
| 10. | Custom 2 | | |

Index 1 to Index 8 allows you to choose the built-in SMS service provider. If the SMS service provider is not on the list, you can configure Index 9 and Index 10 to add the new service provider to Vigor router.

3. Choose any index number (e.g., Index 1 in this case) to configure the SMS Provider setting. In the following page, type the username and password and set the quota that the router can send the message out.

Object Settings >> SMS / Mail Service Object

Profile Index: 1

| | |
|------------------|---------------------------------------------------|
| Profile Name | <input type="text" value="Local number"/> |
| Service Provider | <input type="text" value="kotsms.com.tw (TW)"/> ▼ |
| Username | <input type="text" value="abc5026"/> |
| Password | <input type="password" value="•••"/> |
| Quota | <input type="text" value="3"/> |
| Sending Interval | <input type="text" value="3"/> (seconds) |

- After finished the settings, click **OK** to return to previous page. Now you have finished the configuration of the SMS Provider profile setting.

Object Settings >> SMS / Mail Service Object

| SMS Provider | | Mail Server | Set to Factory Default |
|--------------|--------------|--------------------|----------------------------------------|
| Index | Profile Name | SMS Provider | |
| 1. | Local number | kotsms.com.tw (TW) | |
| 2. | | kotsms.com.tw (TW) | |
| 3. | | kotsms.com.tw (TW) | |
| 4. | | kotsms.com.tw (TW) | |
| 5. | | kotsms.com.tw (TW) | |
| 6. | | kotsms.com.tw (TW) | |
| 7. | | kotsms.com.tw (TW) | |
| 8. | | kotsms.com.tw (TW) | |
| 9. | Custom 1 | | |
| 10. | Custom 2 | | |

- Open **Object Settings>>Notification Object** to configure the event conditions of the notification.

Object Settings >> Notification Object

| | | | Set to Factory Default |
|-------|--------------|----------|----------------------------------------|
| Index | Profile Name | Settings | |
| 1. | | | |
| 2. | | | |
| 3. | | | |
| 4. | | | |
| 5. | | | |
| 6. | | | |
| 7. | | | |
| 8. | | | |

- Choose any index number (e.g., Index 1 in this case) to configure conditions for sending the SMS. In the following page, type the name of the profile and check the Disconnected and Reconnected boxes for WAN to work in concert with the topic of this paper.

Object Settings >> Notification Object

Profile Index: 1

| Profile Name | <input type="text" value="WAN_Notify"/> | | |
|--------------|--------------------------------------------------|-------------------------------------------------|--|
| Category | Status | | |
| WAN | <input checked="" type="checkbox"/> Disconnected | <input checked="" type="checkbox"/> Reconnected | |
| VPN Tunnel | <input type="checkbox"/> Disconnected | <input type="checkbox"/> Reconnected | |

- After finished the settings, click **OK** to return to previous page. You have finished the configuration of the notification object profile setting.

Object Settings >> Notification Object

| [Set to Factory Default](#) |

| Index | Profile Name | Settings |
|-------|--------------|----------|
| 1. | WAN_Notify | WAN |
| 2. | | |
| 3. | | |
| 4. | | |
| 5. | | |
| 6. | | |
| 7. | | |
| 8. | | |

- Now, open **Application >> SMS / Mail Alert Service**. Use the drop down list to choose SMS Provider and the Notify Profile (specify the time of sending SMS). Then, type the phone number in the field of Recipient (the one who will receive the SMS).

Application >> SMS / Mail Alert Service

| [Set to Factory Default](#) |

| SMS Provider | | Mail Server | | |
|---------------------------------------|------------------|-------------|----------------|-------------------------------------------|
| Index | SMS Provider | Recipient | Notify Profile | Schedule(1-15) |
| 1 <input checked="" type="checkbox"/> | 1 - Local number | 0912345678 | 1 - WAN_Notify | <input type="text"/> <input type="text"/> |
| 2 <input type="checkbox"/> | 1 - Local number | | 1 - WAN_Notify | <input type="text"/> <input type="text"/> |
| 3 <input type="checkbox"/> | 1 - Local number | | 1 - WAN_Notify | <input type="text"/> <input type="text"/> |
| 4 <input type="checkbox"/> | 1 - Local number | | 1 - WAN_Notify | <input type="text"/> <input type="text"/> |
| 5 <input type="checkbox"/> | 1 - Local number | | 1 - WAN_Notify | <input type="text"/> <input type="text"/> |
| 6 <input type="checkbox"/> | 1 - Local number | | 1 - WAN_Notify | <input type="text"/> <input type="text"/> |
| 7 <input type="checkbox"/> | 1 - Local number | | 1 - WAN_Notify | <input type="text"/> <input type="text"/> |
| 8 <input type="checkbox"/> | 1 - Local number | | 1 - WAN_Notify | <input type="text"/> <input type="text"/> |
| 9 <input type="checkbox"/> | 1 - Local number | | 1 - WAN_Notify | <input type="text"/> <input type="text"/> |
| 10 <input type="checkbox"/> | 1 - Local number | | 1 - WAN_Notify | <input type="text"/> <input type="text"/> |

- Click **OK** to save the settings. Later, if one of the WAN connections fails in your router, the system will send out SMS to the phone number specified. If the router has only one WAN interface, the system will send out SMS to the phone number while reconnecting the WAN interface successfully.

Remark: How the customize the SMS Provider

Choose one of the Index numbers (9 or 10) allowing you to customize the SMS Provider. In the web page, type the URL string of the SMS provider and type the username and password. After clicking OK, the new added SMS provider will be added and will be available for you to specify for sending SMS out.

Object Settings >> SMS / Mail Service Object

Profile Index: 9

| | |
|--------------------------------------------------------------------------------------------------------------------------------------------------------------------------------------------------------------------|------------------------------------------------------------------------|
| Profile Name | <input type="text" value="Custom 1"/> |
| Service Provider | <input type="text" value="clickatell"/> |
| | <div style="border: 1px solid gray; height: 50px; width: 100%;"></div> |
| Please contact with your SMS provide to get the exact URL String eg:bulksms.vsms.net:5567/eapi/submission/send_sms/2/2.0?username===txtUser### &password===txtPwd###&msisdn===txtDest###&message===txtMsg### | |
| Username | <input type="text" value="ilan123"/> |
| Password | <input type="password" value="••••••"/> |
| Quota | <input type="text" value="3"/> |
| Sending Interval | <input type="text" value="3"/> (seconds) |

4.7 How to Create an Account for MyVigor

The website of MyVigor (a server located on <http://myvigor.draytek.com>) provides several useful services (such as Anti-Spam, Web Content Filter, Anti-Intrusion, and etc.) to filtering the web pages for the sake of protecting your system.

To access into MyVigor for getting more information, please create an account for MyVigor.

4.7.1 Create an Account via Vigor Router

1. Click **CSM>> Web Content Filter Profile**. The following page will appear.

CSM >> Web Content Filter Profile

Web-Filter License
[Status:Not Activated] [Activate](#)

| | | |
|--------------------|---------------|---------------------------|
| Setup Query Server | auto-selected | Find more |
| Setup Test Server | auto-selected | Find more |

Web Content Filter Profile Table: [Set to Factory Default](#)

| Profile | Name | Profile | Name |
|--------------------|---------|--------------------|------|
| 1. | Default | 5. | |
| 2. | | 6. | |
| 3. | | 7. | |
| 4. | | 8. | |

Administration Message (Max 255 characters) Cache : [L1 + L2 Cache](#) ▾

```
<body><center><br><br><br><p>The requested Web page <br> from %SIP% <br>to %URL%  
<br>that is categorized with %CL% <br>has been blocked by %RNAME% Web Content  
Filter.<p>Please contact your system administrator for further  
information.</center></body>
```

Or

Click **System Maintenance>>Activation** to open the following page.

System Maintenance >> Activation Activate via interface : auto-selected ▾

Web-Filter License
[Status:Not Activated] [Activate](#)

Authentication Message

```
Activation authenticate fail, contact with support@draytek.com, 2012-10-30 16:17:01
```

2. Click the **Activate** link. A login page for MyVigor web site will pop up automatically.



Please take a moment to register.
Membership Registration entitles you to upgrade firmware for your purchased product and receive news about upcoming products and services!

LOGIN

UserName :

Password :

Auth Code : **t x x h d d**

If you cannot read the word, [click here](#)

[Forgotten password?](#)

Don't have a MyVigor Account ? [Create an account now](#)

If you are having difficulty logging in, contact our customer service.
Customer Service : (888) 3 597 2727 or

3. Click the link of **Create an account now**.
4. Check to confirm that you accept the Agreement and click **Accept**.

Register

Create an account - Please enter personal profile.

- 1 Agreement
- 2 Personal Information
- 3 Preferences
- 4 Completion

===== MyVigor Agreement =====

1. Agreement
Draytek provides MyVigor(myvigor.draytek.com) service according to this agreement. When you use MyVigor service, it means that you have read, understand and agree to accept the items listed in this agreement. Draytek can modify or change the content of the items without any reasons. It is suggested for you to notice the modifications or changes at any time. If you still use MyVigor service after knowing the modifications and changes of this service, it means you have read, understand and agree to accept the modifications and changes. If you do not agree the content of this agreement, please stop using MyVigor service.

2. Registration
To use this service, you have to agree the following conditions:
(a) Provide your complete and correct information according to the registration steps of this service.
(b) If you provide any incorrect or fake information here, DrayTek has the right to pause or terminate

I have read and understand the above Agreement. (Use the scroll bar to view the entire agreement)

5. Type your personal information in this page and then click **Continue**.

Register

Create an account - Please enter personal profile. (Fields marked by (*) are required)

1 Agreement

2 Personal Information

3 Preferences

4 Completion

Account Information

UserName:*
(3 - 20 characters)

Password:*
(4 - 20 characters : Do not set the same as the username.)

Confirm Password:*

Personal Information

First Name:*

Last Name:*

Company Name:

Email Address:*
Please note that a valid E-mail address is required to receive the Subscription Code. You will need this code to activate your account.

Tel: -

Country:*

Career:*

6. Choose proper selection for your computer and click **Continue**.

Register

Create an account - Please enter personal profile.

1 Agreement

2 Personal Information

3 Preferences

4 Completion

How did you find out about this website?

What kind of anti-virus do you use?

I would like to subscribe to the MyVigor e-letter.

I would like to receive DrayTek product news.

Please select the mail server for receiving the verification mail.

7. Now you have created an account successfully. Click **START**.

Register
Create an account - Please enter personal profile.

1 Agreement
2 Personal Information
3 Preferences
4 Completion

Completion

A confirmation email has been sent to **mary_ted@tech.com**
Please click on the activation link in the email
to activate your account

START

8. Check to see the confirmation *email* with the title of **New Account Confirmation Letter from myvigor.draytek.com**.

***** This is an automated message from myvigor.draytek.com. *****

Thank you (**Mary**) for creating an account.

Please click on the activation link below to activate your account

Link : [Activate my Account](#)

9. Click the **Activate my Account** link to enable the account that you created. The following screen will be shown to verify the register process is finished. Please click **Login**.

Register

Search for this site GO

Register Confirm

Thank for your register in VigorPro Web Site
The Register process is completed

Close Login

10. When you see the following page, please type in the account and password (that you just created) in the fields of **UserName** and **Password**.



Please take a moment to register.
Membership Registration entitles you to upgrade firmware for your purchased product and receive news about upcoming products and services!

LOGIN

UserName :

Password :

Auth Code : **T4he1C**

If you cannot read the word, [click here](#)

[Forgotten password?](#)

Don't have a MyVigor Account ? [Create an account now](#)

If you are having difficulty logging in, contact our customer service.
Customer Service : (886) 3 597 2727 or

11. Now, click **Login**. Your account has been activated. You can access into MyVigor server to activate the service (e.g., WCF) that you want.

4.7.2 Create an Account via MyVigor Web Site

1. Access into <http://myvigor.draytek.com>. Find the line of **Not registered yet?**. Then, click the link **Click here!** to access into next page.

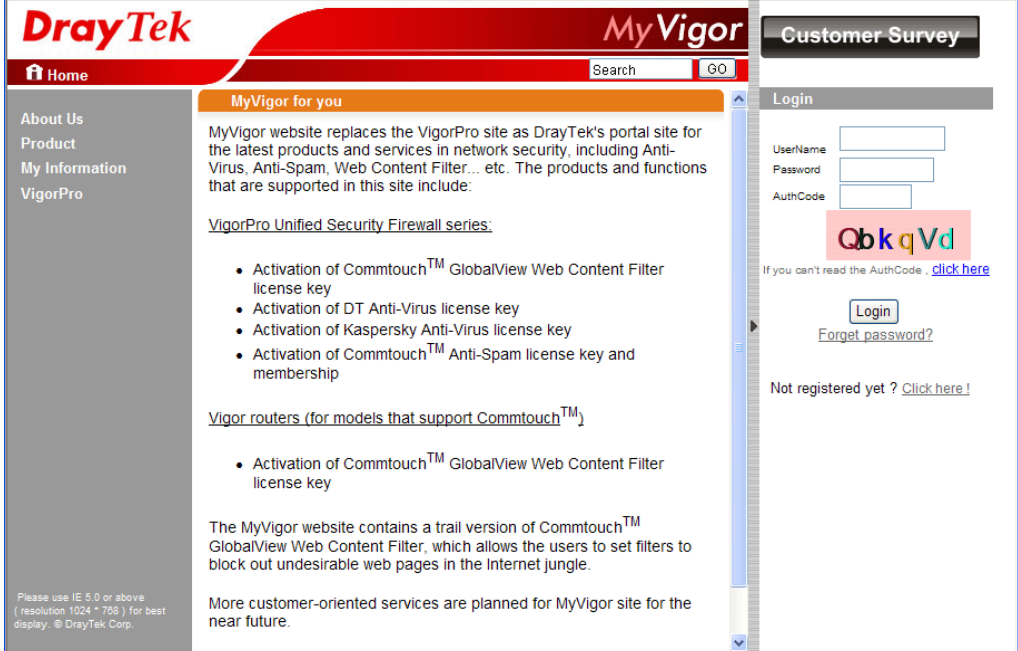

DrayTek MyVigor Customer Survey

Home Search GO

MyVigor for you

MyVigor website replaces the VigorPro site as DrayTek's portal site for the latest products and services in network security, including Anti-Virus, Anti-Spam, Web Content Filter... etc. The products and functions that are supported in this site include:

VigorPro Unified Security Firewall series:

- Activation of Commtouch™ GlobalView Web Content Filter license key
- Activation of DT Anti-Virus license key
- Activation of Kaspersky Anti-Virus license key
- Activation of Commtouch™ Anti-Spam license key and membership

Vigor routers (for models that support Commtouch™)

- Activation of Commtouch™ GlobalView Web Content Filter license key

The MyVigor website contains a trial version of Commtouch™ GlobalView Web Content Filter, which allows the users to set filters to block out undesirable web pages in the Internet jungle.

More customer-oriented services are planned for MyVigor site for the near future.

Please use IE 5.0 or above (resolution 1024 * 768) for best display. © DrayTek Corp.

Login

UserName

Password

AuthCode **QbkqVd**

If you can't read the AuthCode, [click here](#)

[Forget password?](#)

Not registered yet ? [Click here!](#)

2. Check to confirm that you accept the Agreement and click **Accept**.

Register

Create an account - Please enter personal profile.

1 Agreement

2 Personal Information

3 Preferences

4 Completion

MyVigor Agreement

1. Agreement

Draytek provides MyVigor(myvigor.draytek.com) service according to this agreement. When you use MyVigor service, it means that you have read, understand and agree to accept the items listed in this agreement. Draytek can modify or change the content of the items without any reasons. It is suggested for you to notice the medications or changes at any time. If you still use MyVigor service after knowing the modifications and changes of this service, it means you have read, understand and agree to accept the modifications and changes. If you do not agree the content of this agreement, please stop using MyVigor service.

2. Registration

To use this service, you have to agree the following conditions:

(a) Provide your complete and correct information according to the registration steps of this service.

(b) If you provide any incorrect or fake information here, DrayTek has the right to pause or terminate your account.

I have read and understand the above Agreement. (Use the scroll bar to view the entire agreement)

<< Back Accept >>

3. Type your personal information in this page and then click **Continue**.

Register

Create an account - Please enter personal profile. (Fields marked by (*) are required)

1 Agreement

2 Personal Information

3 Preferences

4 Completion

Account Information

UserName:* Mary Check Account

(3 ~ 20 characters)

Password:* Password

(4 ~ 20 characters : Do not set the same as the username.)

Confirm Password:* Password

Personal Information

First Name:* First Name

Last Name:* Last Name

Company Name: Company Name

Email Address:* Email Address

Please note that a valid E-mail address is required to receive the Subscription Code. You will need this code to activate your account.

Tel: Tel

Country:* SWITZERLAND

Career:* Supervisor

<< Back Continue >>

4. Choose proper selection for your computer and click **Continue**.

Register

Create an account - Please enter personal profile.

1 Agreement

2 Personal Information

3 Preferences

4 Completion

How did you find out about this website? Internet

What kind of anti-virus do you use? AntiVir

I would like to subscribe to the MyVigor e-letter.

I would like to receive DrayTek product news.

Please select the mail server for receiving the verification mail. Global Server

<< Back Continue >>

5. Now you have created an account successfully. Click START.

Register
Create an account - Please enter personal profile.

1 Agreement
2 Personal Information
3 Preferences
4 Completion

Completion
A confirmation email has been sent to **mary_ted@tech.com**
Please click on the activation link in the email
to activate your account

START

6. Check to see the confirmation *email* with the title of **New Account Confirmation Letter from myvigor.draytek.com**.

***** This is an automated message from myvigor.draytek.com.*****

Thank you (**Mary**) for creating an account.

Please click on the activation link below to activate your account

Link : [Activate my Account](#)

7. Click the **Activate my Account** link to enable the account that you created. The following screen will be shown to verify the register process is finished. Please click **Login**.

Register Search for this site

Register Confirm

The Confirm message of New Owner(Mary) maybe timeout
Please try again or contact to draytek.com

Close Login

8. When you see the following page, please type in the account and password (that you just created) in the fields of **UserName** and **Password**. Then type the code in the box of Auth Code according to the value displayed on the right side of it.



Please take a moment to register.
Membership Registration entitles you to upgrade firmware for your purchased product and receive news about upcoming products and services!

LOGIN

UserName :

Password :

Auth Code : **T4he1C**

If you cannot read the word, [click here](#)

[Forgotten password?](#)

Don't have a MyVigor Account ? [Create an account now](#)

If you are having difficulty logging in, contact our customer service.
Customer Service : (886) 3 597 2727 or

Now, click **Login**. Your account has been activated. You can access into MyVigor server to activate the service (e.g., WCF) that you want.

4.8 How to Configure Certain Computers Accessing to Internet

We can specify certain computers (e.g., 192.168.1.10 ~ 192.168.1.20) accessing to Internet through Vigor router. Others (e.g., 192.168.1.31 and 192.168.1.32) outside the range can get the source from LAN only.

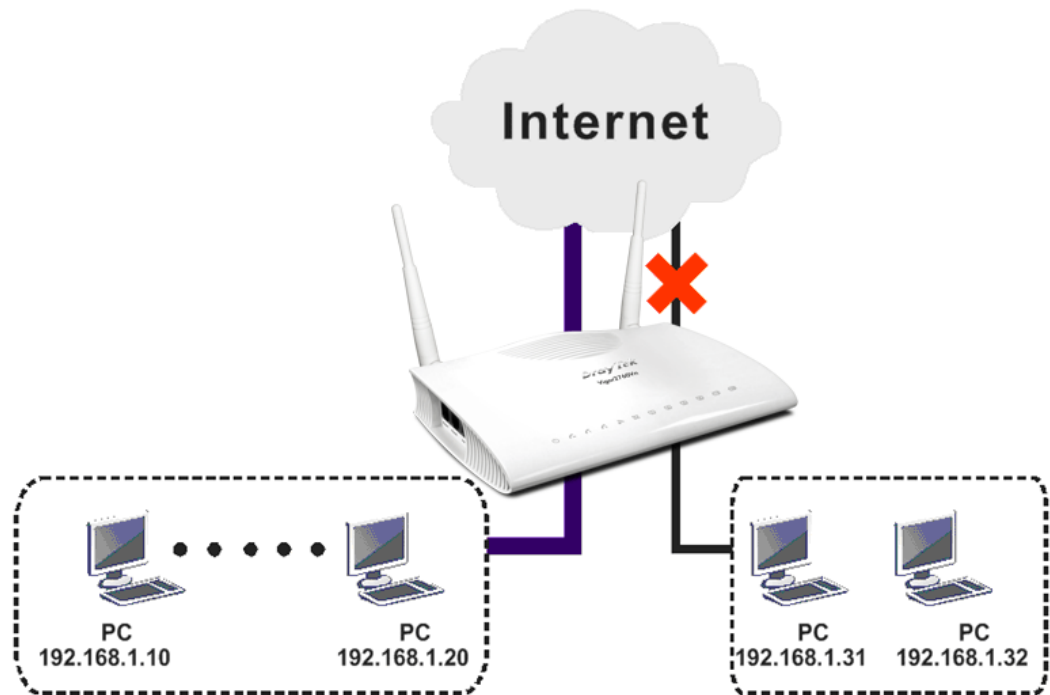

The way we can use is to set two rules under **Firewall**. For **Rule 1** of **Set 2** under **Firewall>>Filter Setup** is used as the default setting, we has to create a new rule starting from Filter Rule 2 of Set 2.

1. Access into the web user interface of Vigor router.
2. Open **Firewall>>Filter Setup**. Click the **Set 2** link and choose the **Filter Rule 2** button.

Firewall >> Filter Setup

Filter Setup | [Set to Factory Default](#) |

| Set | Comments | Set | Comments |
|-----------|---------------------|-----|----------|
| 1. | Default Call Filter | 7. | |
| 2. | Default Data Filter | 8. | |
| 3. | | 9. | |
| 4. | | 10. | |
| 5. | | 11. | |
| 6. | | 12. | |

Firewall >> Filter Setup >> Edit Filter Set

Filter Set 2
Comments:

| Filter Rule | Active | Comments | Move Up | Move Down |
|-------------|-------------------------------------|-----------------|--------------------|----------------------|
| 2 | <input checked="" type="checkbox"/> | xNetBios -> DNS | UP | Down |
| 3 | <input type="checkbox"/> | | UP | Down |
| 4 | <input type="checkbox"/> | | UP | Down |

3. Check the box of **Check to enable the Filter Rule**. Type the comments (e.g., **block_all**). Choose **Block If No Further Match** for the **Filter** setting. Then, click **OK**.

Firewall >> Edit Filter Set >> Edit Filter Rule

Filter Set 2 Rule 2

Check to enable the Filter Rule

Comments:

Index(1-15) in [Schedule](#) Setup: , , ,

Clear sessions when schedule ON: Enable

Direction:

Source IP: [Edit](#)

Destination IP: [Edit](#)

Service Type: [Edit](#)

Fragments:

Application

Filter:

Branch to Other Filter Set:

Sessions Control:

Syslog:

Note: In default, the router will check the packets starting with Set 2, Filter Rule 2 to Filter Rule 7. If **Block If No Further Match** for is selected for **Filter**, the firewall of the router would check the packets with the rules starting from Rule 3 to Rule 7. The packets not matching with the rules will be processed according to Rule 2.

4. Next, set another rule. Just open **Firewall>>Filter Setup**. Click the **Set 2** link and choose the **Filter Rule 3** button.
5. Check the box of **Check to enable the Filter Rule**. Type the comments (e.g., **open_ip**). Click the **Edit** button for **Source IP**.

Filter Set 2 Rule 3

Check to enable the Filter Rule

Comments:

Index(1-15) in **Schedule** Setup: , , ,

Clear sessions when schedule ON: Enable

Direction:

Source IP:

Destination IP:

Service Type:

Fragments:

Application **Action/Profile** **Syslog**

Filter:

Branch to Other Filter Set:

- A dialog box will be popped up. Choose **Range Address** as **Address Type** by using the drop down list. Type 192.168.1.10 in the field of **Start IP**, and type 192.168.1.20 in the field of **End IP**. Then, click **OK** to save the settings. The computers within the range can access into the Internet.

IP Address Edit

| | |
|-----------------------|--------------------------|
| Address Type | Range Address |
| Start IP Address | 192.168.1.10 |
| End IP Address | 192.168.1.20 |
| Subnet Mask | 0.0.0.0 |
| Invert Selection | <input type="checkbox"/> |
| IP Group | None |
| or IP Object | None |
| or IP Object | None |
| or IP Object | None |
| IPv6 Group | None |
| or IPv6 Object | None |
| or IPv6 Object | None |
| or IPv6 Object | None |

OK Close

- Now, check the content of **Source IP** is correct or not. The action for **Filter** shall be set with **Pass Immediately**. Then, click **OK** to save the settings.

Firewall >> Edit Filter Set >> Edit Filter Rule

Filter Set 2 Rule 3

Check to enable the Filter Rule

Comments: open_ip

Index(1-15) in **Schedule** Setup: , , ,

Clear sessions when schedule ON: Enable

Direction: LAN/RT/VPN -> WAN

Source IP: 192.168.1.10~192.168.1.20 Edit

Destination IP: Any Edit

Service Type: Any Edit

Fragments: Don't Care

Application

Filter: Action/Profile Pass Immediately

Syslog

Branch to Other Filter Set: None

8. Both filter rules have been created. Click **OK**.

Firewall >> Filter Setup >> Edit Filter Set

Filter Set 2

Comments :

| Filter Rule | Active | Comments | Move Up | Move Down |
|--------------------------------|-------------------------------------|-----------------|-----------|-------------|
| <input type="text" value="1"/> | <input checked="" type="checkbox"/> | xNetBios -> DNS | | <u>Down</u> |
| <input type="text" value="2"/> | <input checked="" type="checkbox"/> | block_all | <u>UP</u> | <u>Down</u> |
| <input type="text" value="3"/> | <input checked="" type="checkbox"/> | open_ip | <u>UP</u> | <u>Down</u> |
| <input type="text" value="4"/> | <input type="checkbox"/> | | <u>UP</u> | <u>Down</u> |
| <input type="text" value="5"/> | <input type="checkbox"/> | | <u>UP</u> | <u>Down</u> |
| <input type="text" value="6"/> | <input type="checkbox"/> | | <u>UP</u> | <u>Down</u> |
| <input type="text" value="7"/> | <input type="checkbox"/> | | <u>UP</u> | |

Next Filter Set 

9. Now, all the settings are configured well. Only the computers with the IP addresses within 192.168.1.10 ~ 192.168.1.20 can access to Internet.

4.9 How to Block Facebook Service Accessed by the Users via Web Content Filter / URL Content Filter

There are two ways to block the facebook service, Web Content Filter and URL Content Filter.

Web Content Filter,

Benefits: Easily and quickly implement the category/website that you want to block.

Note: License is required.

URL Content Filter,

Benefits: Free, flexible for customize webpage.

Note: Manual setting (e.g., one keyword for one website.)

I. Via Web Content Filter

1. Make sure the Web Content Filter (powered by Commtouch) license is valid.

CSM >> Web Content Filter Profile

Web-Filter License [Activate](#)
[Status: **Commtouch**] [Start Date: 2012-12-31 Expire Date: 2013-01-08]

| | | |
|--------------------|--------------------------------------------|---------------------------|
| Setup Query Server | <input type="text" value="auto-selected"/> | Find more |
| Setup Test Server | <input type="text" value="auto-selected"/> | Find more |

Web Content Filter Profile Table: [Set to Factory Default](#)

| Profile | Name | Profile | Name |
|--------------------|---------|--------------------|------|
| 1. | Default | 5. | |
| 2. | | 6. | |
| 3. | | 7. | |
| 4. | | 8. | |

Administration Message (Max 255 characters) Cache :

```
<body><center><br><br><p>The requested Web page <br> from %SIP% <br>to %URL%  
<br>that is categorized with %CL% <br>has been blocked by %RNAME% Web Content  
Filter.<p>Please contact your system administrator for further  
information.</center></body>
```

Legend:
%SIP% - Source IP , %DIP% - Destination IP , %URL% - URL

How to register/activate Web Content Filter (WCF) license? Please visit for getting more information:

***How to Register AI/AV/AS/WCF Service (Service Activation Wizard)**
(<http://www.draytek.com/user/SupportFAQDetail.php?ID=1955>)

***How to Activate Anti-Virus/Anti-Intrusion/Anti-Spam Service**
(<http://www.draytek.com/user/SupportFAQDetail.php?ID=286>)

How to use the Web Content Filter (WCF)
(<http://www.draytek.com/user/SupportFAQDetail.php?ID=1953>)

*** What the Web Content Filter (WCF) license benefits are,**
(<http://www.draytek.com/user/PdInfoDetail.php?Id=110>)

- Open CSM >> **Web Content Filter Profile** to create a WCF profile. Check **Social Networking** with Action, **Block**.

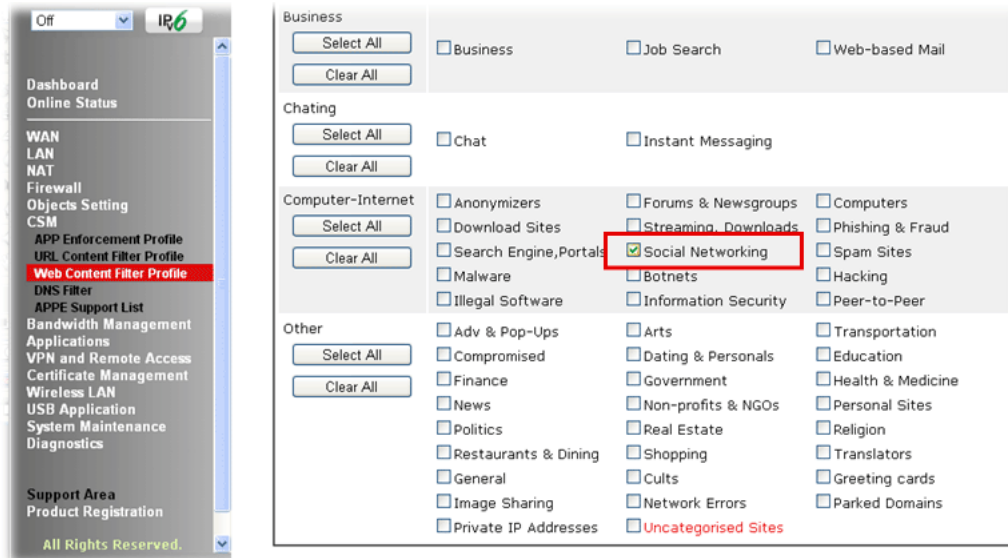

- Enable this profile in **Firewall>>General Setup>>Default Rule**.

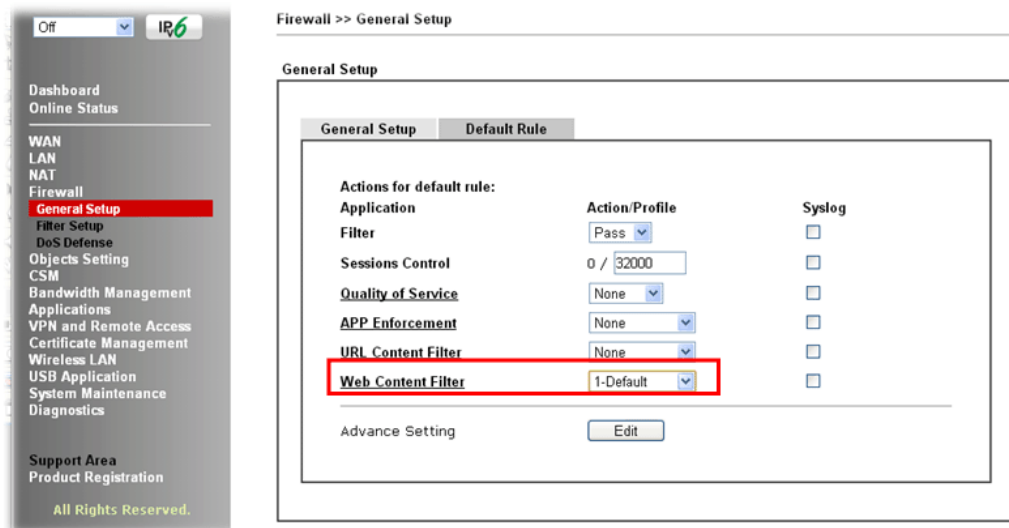

- Next time when someone accesses facebook via this router, the web page would be blocked and the following message would be displayed instead.

The requested Web page
 from 192.168.2.114
 to www.facebook.com/
 that is categorized with [Social Networking]
 has been blocked by Web Content Filter.

Please contact your system administrator for further information.

[Powered by DrayTek]

II. Via URL Content Filter

A. Block the web page containing the word of “Facebook”

1. Open **Object Settings>>Keyword Object**. Click an index number to open the setting page.
2. In the field of **Contents**, please type *facebook*. Configure the settings as the following figure.

Objects Setting >> Keyword Object Setup

Profile Index : 1

| | |
|----------|----------|
| Name | Facebook |
| Contents | facebook |

Limit of Contents: Max 3 Words and 63 Characters.
Each word should be separated by a single space.

You can replace a character with %HEX.
Example:
Contents: backdoor%72 virus keep%20out

Result:
1. backdoor
2. virus
3. keep out

OK Clear Cancel

3. Open **CSM>>URL Content Filter Profile**. Click an index number to open the setting page.
4. Configure the settings as the following figure.

CSM >> URL Content Filter Profile

Profile Index: 1

Profile Name: Facebook

Priority: Either : URL Access Control First Log: None

1.URL Access Control

Enable URL Access Control Prevent web access from IP address

Action: Block Group/Object Selections: Facebook Edit

2.Web Feature

Enable Restrict Web Feature

Action: Pass Cookie Proxy Upload File Extension Profile: None

OK Clear Cancel

5. When you finished the above steps, click **OK**. Then, open **Firewall>>General Setup**.

- Click the **Default Rule** tab. Choose the profile just configured from the drop down list in the field of **URL Content Filter**. Now, users cannot open any web page with the word “facebook” inside.

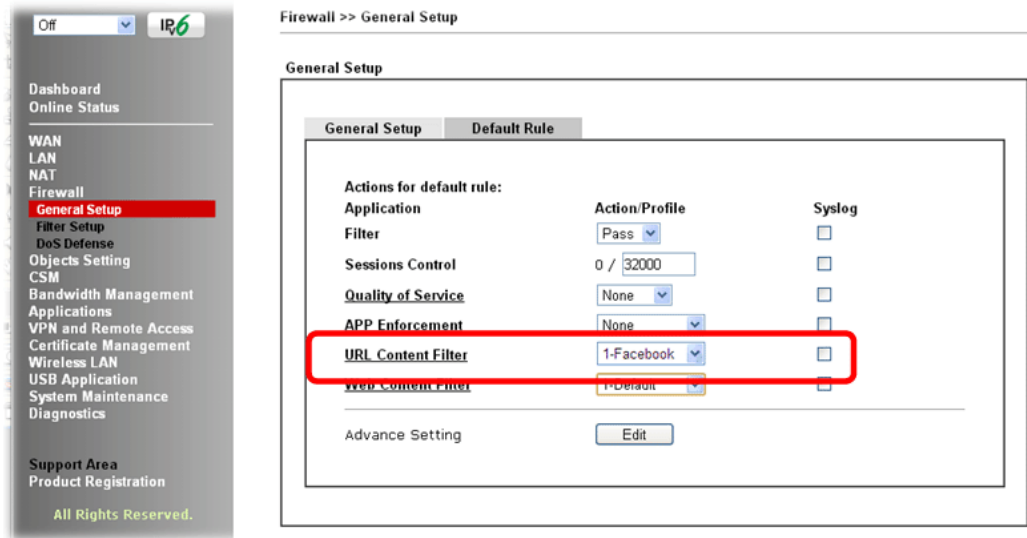

B. Disallow users to play games on Facebook

- Open **Object Settings>>Keyword Object**. Click an index number to open the setting page.
- In the field of **Contents**, please type *apps.facebook*. Configure the settings as the following figure.

Objects Setting >> Keyword Object Setup

Profile Index : 2

| | |
|----------|---------------|
| Name | facebook-apps |
| Contents | apps.facebook |

Limit of Contents: Max 3 Words and 63 Characters.
Each word should be separated by a single space.

You can replace a character with %HEX.
Example:
Contents: backdoo%72 virus keep%20out

Result:

- backdoor
- virus
- keep out

OK Clear Cancel

- Open **CSM>>URL Content Filter Profile**. Click an index number to open the setting page.
- Configure the settings as the following figure.

CSM >> URL Content Filter Profile

Profile Index: 2

Profile Name:

Priority: Log:

1.URL Access Control

Enable URL Access Control Prevent web access from IP address

Action: Group/Object Selections:

2.Web Feature

Enable Restrict Web Feature

Action: Cookie Proxy Upload **File Extension Profile:**

- When you finished the above steps, please open **Firewall>>General Setup**.
- Click the **Default Rule** tab. Choose the profile just configured from the drop down list in the field of URL Content Filter. Now, users cannot open any web page with the word “facebook” inside.

Firewall >> General Setup

General Setup

General Setup Default Rule

| Actions for default rule: | Action/Profile | Syslog |
|---------------------------|------------------------------------------|--------------------------|
| Application | | |
| Filter | <input type="text" value="Pass"/> | <input type="checkbox"/> |
| Sessions Control | <input type="text" value="0 / 60000"/> | <input type="checkbox"/> |
| <u>Quality of Service</u> | <input type="text" value="None"/> | <input type="checkbox"/> |
| <u>APP Enforcement</u> | <input type="text" value="None"/> | <input type="checkbox"/> |
| <u>URL Content Filter</u> | <input type="text" value="2-face.apps"/> | <input type="checkbox"/> |
| <u>Web Content Filter</u> | <input type="text" value="None"/> | <input type="checkbox"/> |

Advance Setting

This page is left blank.

5

Trouble Shooting

This section will guide you to solve abnormal situations if you cannot access into the Internet after installing the router and finishing the web configuration. Please follow sections below to check your basic installation status stage by stage.

- Checking if the hardware status is OK or not.
- Checking if the network connection settings on your computer are OK or not.
- Pinging the router from your computer.
- Checking if the ISP settings are OK or not.
- Backing to factory default setting if necessary.

If all above stages are done and the router still cannot run normally, it is the time for you to contact your dealer for advanced help.

5.1 Check if the Hardware Status Is OK

Follow the steps below to verify the hardware status.

1. Check the power line and WLAN/LAN cable connections. Refer to “**1.3 Hardware Installation**” for details.
2. Turn on the router. Make sure the **ACT LED** blink once per second and the correspondent **LAN LED** is bright.



3. If not, it means that there is something wrong with the hardware status. Simply back to “**1.3 Hardware Installation**” to execute the hardware installation again. And then, try again.

5.2 Check If the Network Connection Settings on Your Computer are OK

Sometimes the link failure occurs due to the wrong network connection settings. After trying the above section, if the link is still failed, please do the steps listed below to make sure the network connection settings is OK.

For Windows



The example is based on Windows 7 (Professional Edition). As to the examples for other operation systems, please refer to the similar steps or find support notes in www.DrayTek.com.

1. Open **All Programs>>Getting Started>>Control Panel**. Click **Network and Sharing Center**.



2. In the following window, click **Change adapter settings**.

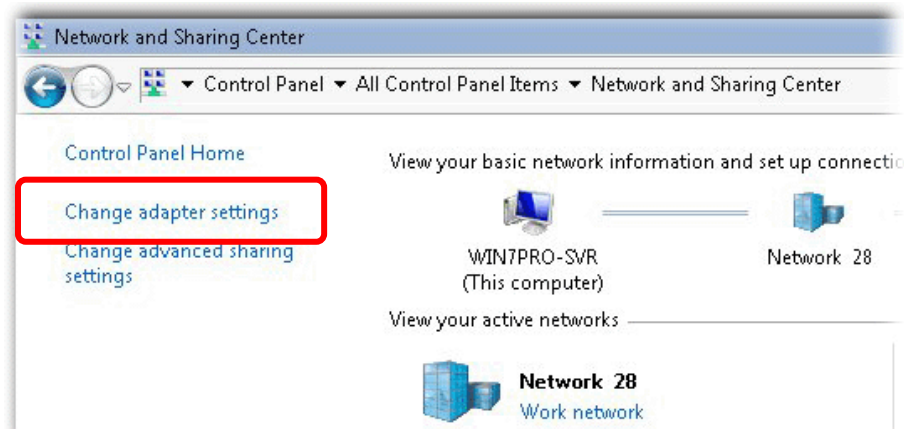

3. Icons of network connection will be shown on the window. Right-click on **Local Area Connection** and click on **Properties**.

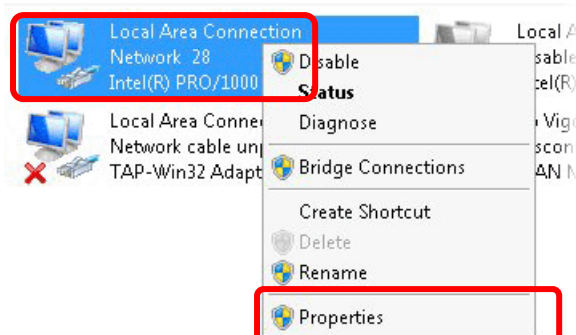

4. Select **Internet Protocol Version 4 (TCP/IP)** and then click **Properties**.

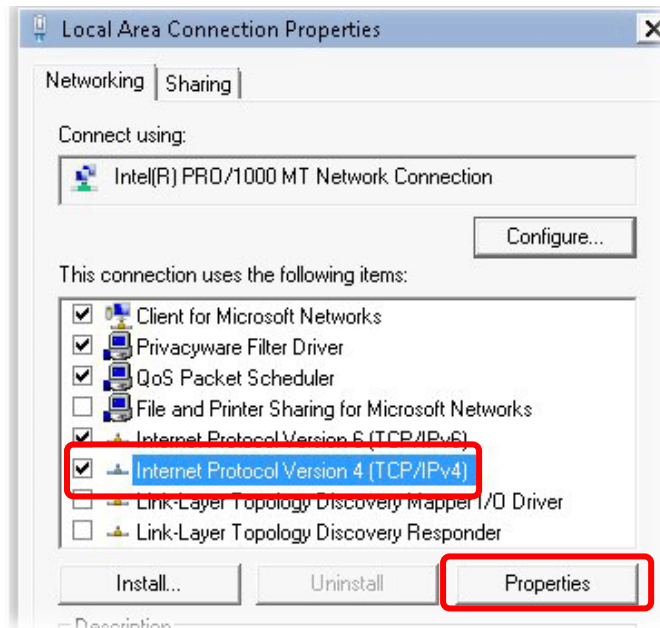

5. Select **Obtain an IP address automatically** and **Obtain DNS server address automatically**. Finally, click **OK**.

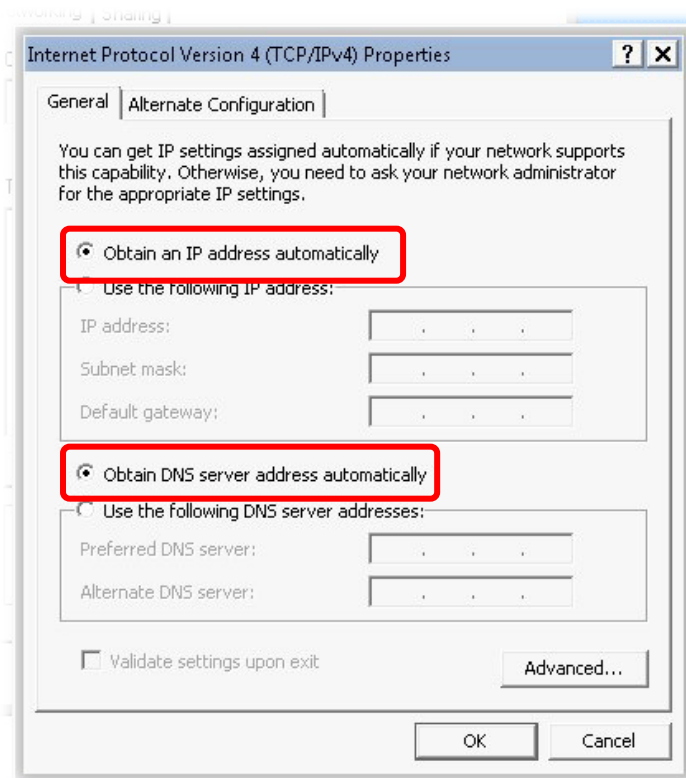

For Mac OS

1. Double click on the current used Mac OS on the desktop.
2. Open the **Application** folder and get into **Network**.
3. On the **Network** screen, select **Using DHCP** from the drop down list of Configure IPv4.

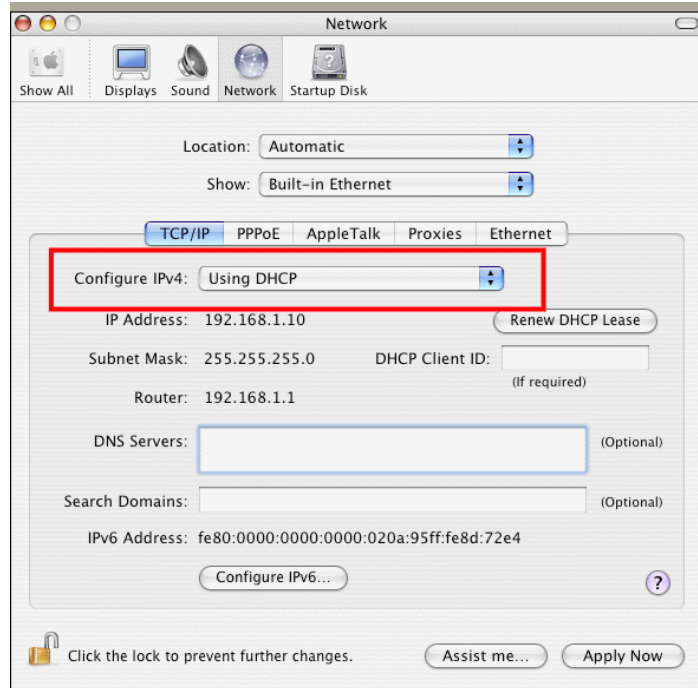

5.3 Pinging the Router from Your Computer

The default gateway IP address of the router is 192.168.1.1. For some reason, you might need to use “ping” command to check the link status of the router. **The most important thing is that the computer will receive a reply from 192.168.1.1.** If not, please check the IP address of your computer. We suggest you setting the network connection as **get IP automatically**. (Please refer to the section 5.2)

Please follow the steps below to ping the router correctly.

For Windows

1. Open the **Command Prompt** window (from **Start menu**> **Run**).
2. Type **command** (for Windows 95/98/ME) or **cmd** (for Windows NT/ 2000/XP/Vista). The DOS command dialog will appear.

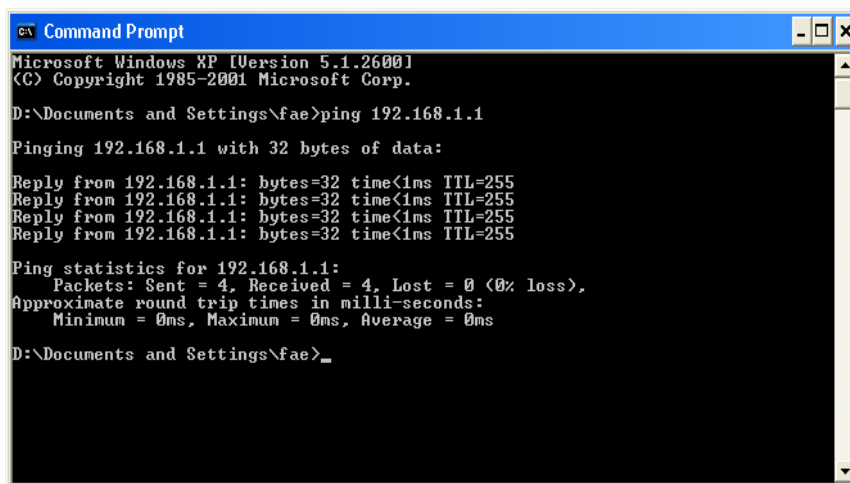

```
Microsoft Windows XP [Version 5.1.2600]
(C) Copyright 1985-2001 Microsoft Corp.

D:\Documents and Settings\fae>ping 192.168.1.1

Pinging 192.168.1.1 with 32 bytes of data:

Reply from 192.168.1.1: bytes=32 time<1ms TTL=255
Reply from 192.168.1.1: bytes=32 time<1ms TTL=255
Reply from 192.168.1.1: bytes=32 time<1ms TTL=255
Reply from 192.168.1.1: bytes=32 time<1ms TTL=255

Ping statistics for 192.168.1.1:
    Packets: Sent = 4, Received = 4, Lost = 0 (0% loss),
    Approximate round trip times in milli-seconds:
        Minimum = 0ms, Maximum = 0ms, Average = 0ms

D:\Documents and Settings\fae>_
```

3. Type ping 192.168.1.1 and press [Enter]. If the link is OK, the line of “**Reply from 192.168.1.1:bytes=32 time<1ms TTL=255**” will appear.
4. If the line does not appear, please check the IP address setting of your computer.

For Mac OS (Terminal)

1. Double click on the current used MacOs on the desktop.
2. Open the **Application** folder and get into **Utilities**.
3. Double click **Terminal**. The Terminal window will appear.
4. Type **ping 192.168.1.1** and press [Enter]. If the link is OK, the line of “**64 bytes from 192.168.1.1: icmp_seq=0 ttl=255 time=xxxx ms**” will appear.

```

Terminal - bash - 80x24
Last login: Sat Jan  3 02:24:18 on ttys1
Welcome to Darwin!
Vigor10:~ draytek$ ping 192.168.1.1
PING 192.168.1.1 (192.168.1.1): 56 data bytes
64 bytes from 192.168.1.1: icmp_seq=0 ttl=255 time=0.755 ms
64 bytes from 192.168.1.1: icmp_seq=1 ttl=255 time=0.697 ms
64 bytes from 192.168.1.1: icmp_seq=2 ttl=255 time=0.716 ms
64 bytes from 192.168.1.1: icmp_seq=3 ttl=255 time=0.731 ms
64 bytes from 192.168.1.1: icmp_seq=4 ttl=255 time=0.72 ms
^C
--- 192.168.1.1 ping statistics ---
5 packets transmitted, 5 packets received, 0% packet loss
round-trip min/avg/max = 0.697/0.723/0.755 ms
Vigor10:~ draytek$

```

5.4 Checking if the ISP Settings are OK

Open **WAN >> Internet Access** page and then check whether the ISP settings are set correctly. Click **Details Page** of WAN1-WAN3 to review the settings that you configured previously.

WAN >> Internet Access

| Internet Access | | | |
|-----------------|--------------|---------------|------------------------------------------------------------------------------------------------------|
| Index | Display Name | Physical Mode | Access Mode |
| WAN1 | | ADSL / VDSL2 | None <input type="button" value="Details Page"/> <input type="button" value="IPv6"/> |
| WAN2 | | Ethernet | Static or Dynamic IP <input type="button" value="Details Page"/> <input type="button" value="IPv6"/> |
| WAN3 | | USB | None <input type="button" value="Details Page"/> <input type="button" value="IPv6"/> |

Note: Only one WAN can support IPv6.

You can configure DHCP client options here.

5.5 Problems with 3G/4G Network Connection

When you have trouble in using 3G network transmission, ensure you are using a supported modem (check for latest support list) and then please check the following:

Check if USB LED lights on or off

You have to wait about 15 seconds after inserting 3G USB Modem into your Vigor2760. Later, the USB LED will light on which means the installation of USB Modem is successful. If the USB LED does not light on, please remove and reinsert the modem again. If it still fails, restart Vigor2760.

USB LED lights on but the network connection does not work

Check the PIN Code of SIM card is disabled or not. Please use the utility of 3G USB Modem to disable PIN code and try again. If it still fails, it might be the compliance problem of system. Please open DrayTek Syslog Tool to capture the connection information (WAN Log) and send the page (similar to the following graphic) to the service center of DrayTek.

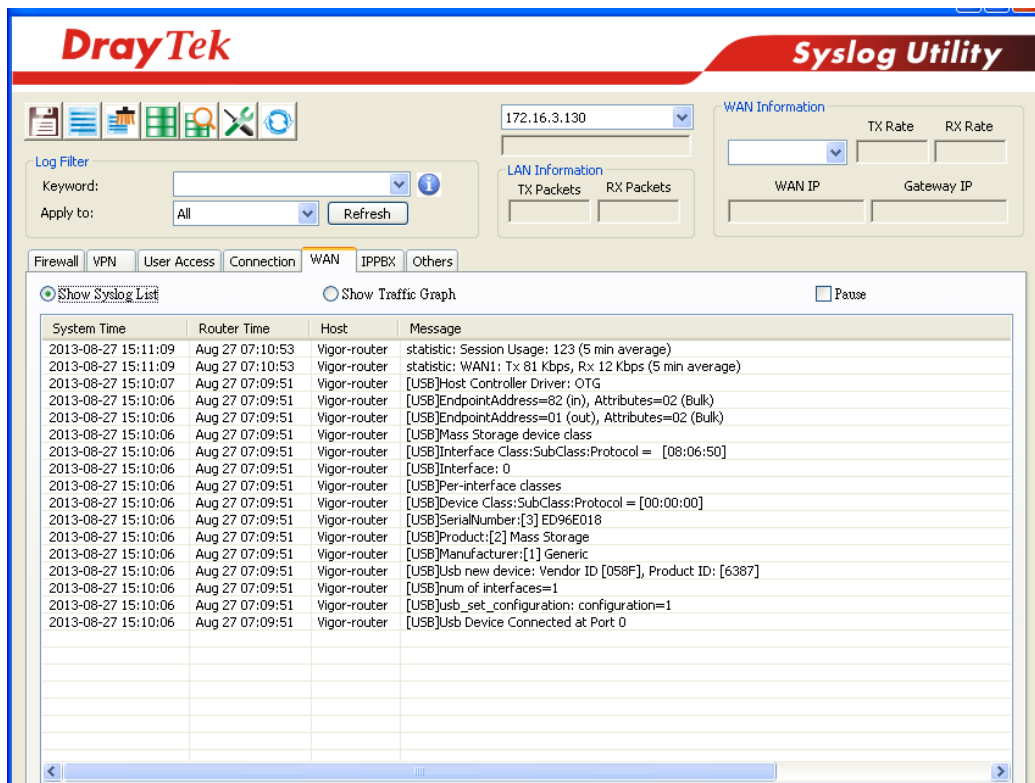

Transmission Rate is not fast enough

Please connect your Notebook with 3G USB Modem to test the connection speed to verify if the problem is caused by Vigor2760. In addition, please refer to the manual of 3G USB Modem for LED Status to make sure if the modem connects to Internet via HSDPA mode. If you want to use the modem indoors, please put it on the place near the window to obtain better signal receiving.

5.6 Backing to Factory Default Setting If Necessary

Sometimes, a wrong connection can be improved by returning to the default settings. Try to reset the router by software or hardware. Such function is available in **Admin Mode** only.



Warning: After pressing **factory default setting**, you will lose all settings you did before. Make sure you have recorded all useful settings before you pressing. The password of factory default is null.

Software Reset

You can reset the router to factory default via Web page. Such function is available in **Admin Mode** only.

Go to **System Maintenance** and choose **Reboot System** on the web page. The following screen will appear. Choose **Using factory default configuration** and click **Reboot Now**. After few seconds, the router will return all the settings to the factory settings.

Reboot System

Do you want to reboot your router ?

Using current configuration
 Using factory default configuration

Reboot Now

Auto Reboot Time Schedule

Index(1-15) in Schedule Setup: , , ,

Note: Action and Idle Timeout settings will be ignored.

OK

Cancel

Hardware Reset

While the router is running (ACT LED blinking), press the **Factory Reset** button and hold for more than 5 seconds. When you see the **ACT LED** blinks rapidly, please release the button. Then, the router will restart with the default configuration.

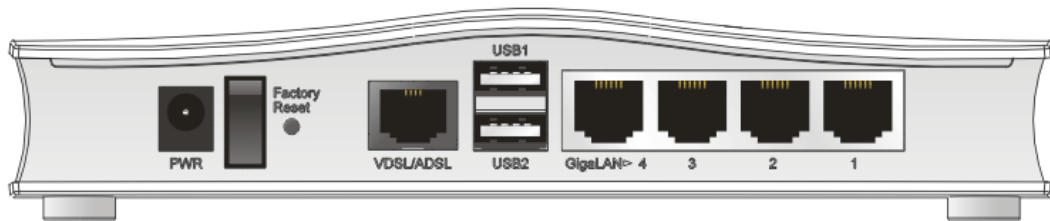

After restore the factory default setting, you can configure the settings for the router again to fit your personal request.

5.7 Getting further help

If the router still does not appear to be operating correctly or you cannot get online to the Internet, please visit our web sites for further troubleshooting advice or to contact our support technicians. Users in the UK/Ireland using qualifying products should visit <http://www.draytek.co.uk/support> where you will find help guides, the knowledgebase and be able to contact support technicians for direct help.

If you are outside the UK or Ireland, please contact support@draytek.com or visit the international support site at www.draytek.com/support .

5.8 Keep up to date

Now that you have your DrayTek product, you may want to keep up to date with product updates (firmware) and other product news, advice or offers for users. Users in the UK/Ireland can subscribe to our mailing list. For details please see www.draytek.co.uk/mailling-list. In other countries, please contact your local distributor/supplier for local options.

5.9 Firmware Updates

Firmware updates for your product ensure that you have the latest set of features, security updates and improvements for your product. Users in the UK/Ireland can download these from www.draytek.co.uk/support

Please note that if your Vigor 2760 product has firmware version 1.x.x or earlier then it can only update to later 1.x.x firmware. If your Vigor 2760 has firmware version 3.7.5 or later ('Delight/DrayOS' hardware) then you can upgrade to any compatible later firmware. You cannot use Delight/DrayOS firmware on original (classic) Vigor 2760 models or vice-versa.