

Vigor2865 Series

VDSL 35b Security Firewall

Quick Start Guide

Routers- RF Models

Version: V1.5

Web registration is preferred. You can register your Vigor router via <https://myvigor.draytek.com>.

Due to the continuous evolution of DrayTek technology, all routers will be regularly upgraded. Please consult the DrayTek web site for more information on newest firmware, tools and documents.
<https://www.draytek.co.uk>



Safety and Warranty for Wireless Models of Vigor Routers

Safety	<ul style="list-style-type: none"> ● Read the installation guide thoroughly before you set up the router. ● The router is a complicated electronic unit that may be repaired only by authorized and qualified personnel. Do not try to open or repair the router yourself. ● Do not place the router in a damp or humid place, e.g. a bathroom. ● Do not stack the routers.
Instructions	<ul style="list-style-type: none"> ● The router should be used in a sheltered area, within a temperature range of 5 to +40 Celsius. ● Do not expose the router to direct sunlight or other heat sources. The housing and electronic components may be damaged by direct sunlight or heat sources. ● Do not deploy the cable for LAN connection outdoor to prevent electronic shock hazards. ● Do not power off the router when saving configurations or firmware upgrades. It may damage the data in a flash. Please disconnect the Internet connection on the router before powering it off when a TR-069/ ACS server manages the router. ● Keep the package out of reach of children. ● When you want to dispose of the router, please follow local regulations on conservation of the environment.
Warranty	<p>We warrant to the original end user (purchaser) that the router will be free from any defects in workmanship or materials for a period of two (2) years from the date of purchase from a DrayTek authorized dealer in the UK/Ireland. Please keep your purchase receipt in a safe place as it serves as proof of date of purchase. During the warranty period, and upon proof of purchase, should the product have indications of failure due to faulty workmanship and/or materials, we will, at our discretion, repair or replace the defective products or components, without charge for either parts or labour, to whatever extent we deem necessary to restore the product to proper operating condition. Any replacement will consist of a new or re-manufactured functionally equivalent product of equal value, and will be offered solely at our discretion. This warranty will not apply if the product is modified, misused, tampered with, damaged by external factors, used with unapproved accessories or subjected to abnormal working conditions. Warranty applies to hardware only, not software or firmware. Defects which do not significantly affect the usability of the product will not be covered by the warranty. We reserve the right to revise the manual and online documentation and to make changes from time to time in the contents hereof without obligation to notify any person of such revision or changes.</p>
Importer	<p>UK - CMS Distribution Limited, 15 Worship Street, London, EC2A 2DT Ireland - CMS Distribution Limited, Bohola Road, Kiltimagh, Co Mayo, Ireland</p>

External Power Supply (Power Adapter) Information

	1	2	3	4	5	6	7	8	9
A Manufacturer	CWT	CWT	CWT	CWT	CWT	APD	APD	APD	APD
B Address	No. 222, Sec. 2, Nankan Rd., Lujhu Township, Taoyuan County 338, Taiwan	No. 222, Sec. 2, Nankan Rd., Lujhu Township, Taoyuan County 338, Taiwan	No. 222, Sec. 2, Nankan Rd., Lujhu Township, Taoyuan County 338, Taiwan	No. 222, Sec. 2, Nankan Rd., Lujhu Township, Taoyuan County 338, Taiwan	No. 222, Sec. 2, Nankan Rd., Lujhu Township, Taoyuan County 338, Taiwan	No. 5, Lane 83, Lung-Sou St., Taoyuan City 330, Taiwan	No. 5, Lane 83, Lung-Sou St., Taoyuan City 330, Taiwan	No. 5, Lane 83, Lung-Sou St., Taoyuan City 330, Taiwan	No. 5, Lane 83, Lung-Sou St., Taoyuan City 330, Taiwan
C Model identifier	2ABB012F UK 2ABB012F EU	2ABB018F UK 2ABB018F EU	2ABL024F UK 2ABL024F EU	2ABL030F UK 2ABL030F EU	2ABN036F UK 2ABN036F EU	WA-12M12FG WA-12M12FK	WB-18D12FG WB-18D12FK	WA-24Q12FG WA-24Q12FK	WA-36A12FG WA-36A12FK
D Input voltage	100-240V	100-240V	100-240V	100-240V	100-240V	100-240V	100-240V	100-240V	100-240V
E Input AC frequency	50/60Hz	50/60Hz	50/60Hz	50/60Hz	50/60Hz	50/60Hz	50/60Hz	50/60Hz	50/60Hz
Output voltage DC	12.0V	12.0V	12.0V	12.0V	12.0V	12.0V	12.0V	12.0V	12.0V
F Output current	1.0A	1.5A	2.0A	2.5A	3.0A	1.0A	1.5A	2.0A	3.0A
G Output power	12.0W	18.0W	24.0W	30.0W	36.0W	12.0W	18.0W	24.0W	36.0W
H Average active efficiency	84.9%	86.2%	87.6%	87.8%	89.8%	83.7%	85.4%	88.6%	88.2%
I Efficiency at low load 10%	73.6%	78.0%	81.3%	83.3%	83.7%	74.5%	80.5%	86.4%	85.4%
J No-load power consumption	0.07W	0.07W	0.07W	0.07W	0.07W	0.07W	0.10W	0.07W	0.10W

Note: Product specification is subject to continuous evolution which may not always be reflected in current documentation. For the formal specification and details of the supported features of your product, please refer only to the web site at www.draytek.co.uk.



Declaration of Conformity

Hereby, DrayTek Corporation declares that the equipment type Vigor2865 is in compliance with the Radio Equipment Regulations 2017 (SI 2017 No. 1206), The Electrical Equipment (Safety) Regulations 2016 (SI 2016 No. 1101), and The Restriction of the Use of Certain Hazardous Substances in Electrical and Electronic Equipment Regulations 2012 (SI 2012 No. 3032).

The full text of the UKCA Declaration of Conformity is available at the following internet address:

<https://fw.draytek.com.tw/Vigor2865/Document/CE/>

Manufacturer: DrayTek Corp.

Address: No. 26, Fushing Rd., Hukou, Hsinchu Industrial Park, Hsinchu 303, Taiwan

Product: Vigor2865 Series

Frequency Information for UK area:

2.4GHz WLAN	For ac series, 2400MHz - 2483MHz, max. TX power:19.78dBm *1
	For ax series, 2400MHz - 2483MHz, max. TX power:19.86dBm *1
5GHz WLAN	For ac series, 5150MHz - 5350MHz, max. TX power:22.84dBm *2 5470MHz - 5725MHz, max. TX power:27.88dBm *2 5745MHz - 5825MHz, max. TX power:27.81dBm *2
	For ax series, 5150MHz - 5350MHz, max. TX power: 22.79dBm *2 5470MHz - 5725MHz, max. TX power: 29.78dBm *2
5G-NR	n1[1920-1980 MHz (TX); 2110-2170 MHz (RX)]; n3[1710-1785 MHz (TX); 1805-1880 MHz (RX)]; n7[2500-2570 MHz (TX); 2620-2690 MHz (RX)]; n8[880-915 MHz (TX); 925-960 MHz (RX)]; n20[832-862 MHz (TX); 791-821 MHz (RX)]; n28[703-748 MHz (TX); 758-803 MHz (RX)]; n38[2570-2620 MHz (TX/RX)]; n40[2300-2400 MHz (TX/RX)]; n77[3300-4200 MHz (TX/RX)]; n78[3300-3800 MHz (TX/RX)] *4
LTE	B1[1920-1980 MHz (TX); 2110-2170 MHz (RX)]; B3[1710-1785 MHz (TX); 1805-1880 MHz (RX)]; B7[2500-2570 MHz (TX); 2620-2690 MHz (RX)]; B8[880-915 MHz (TX); 925-960 MHz (RX)]; B20[832-862 MHz (TX); 791-821 MHz (RX)]; B28[703-748 MHz (TX); 758-803 MHz (RX)]; B38[2570-2620 MHz (TX); 2570-2620 MHz (RX)]; B40[2300-2400 MHz (TX); 2300-2400 MHz (RX)]*3
3G	B1[1920-1980 MHz (TX); 2110-2170 MHz (RX)]; B8[880-915 MHz (TX); 925-960 MHz (RX)] *3
	Requirements in UK. 5150MHz-5350MHz is for indoor use only.

(*1: for 2.4GHz WLAN model; *2: for 5GHz WLAN model; *3: for LTE model; *4: for 5G-NR model)

This product is designed for LTE, DSL and 2.4GHz /5GHz WLAN network use in the UK & Ireland.



Declaration of Conformity

Hereby, DrayTek Corporation declares that the equipment type Vigor2865 is in compliance with Radio Equipment Directive 2014/53/EU, Low Voltage Directive 2014/35/EU and RoHS 2011/65/EU.

The full text of the EU Declaration of Conformity is available at the following internet address:

<https://fw.draytek.com.tw/Vigor2865/Document/CE/>

Manufacturer: DrayTek Corp.

Address: No. 26, Fushing Rd., Hukou, Hsinchu Industrial Park, Hsinchu 303, Taiwan

Product: Vigor2865 Wireless Series

Frequency Information for Europe area:

2.4GHz WLAN	For ac series, 2400MHz - 2483MHz, max. TX power: 19.78dBm *1
	For ax series, 2400MHz - 2483MHz, max. TX power: 19.86dBm *1
5GHz WLAN	For ac series, 5150MHz - 5350MHz, max. TX power: 22.84dBm *2 5470MHz - 5725MHz, max. TX power: 27.88dBm *2
	For ax series, 5150MHz - 5350MHz, max. TX power: 22.79dBm *2 5470MHz - 5725MHz, max. TX power: 29.78dBm *2
5G-NR	n1[1920-1980 MHz (TX); 2110-2170 MHz (RX)]; n3[1710-1785 MHz (TX); 1805-1880 MHz (RX)]; n7[2500-2570 MHz (TX); 2620-2690 MHz (RX)]; n8[880-915 MHz (TX); 925-960 MHz (RX)]; n20[832-862 MHz (TX); 791-821 MHz (RX)]; n28[703-748 MHz (TX); 758-803 MHz (RX)]; n38[2570-2620 MHz (TX/RX)]; n40[2300-2400 MHz (TX/RX)]; n77[3300-4200 MHz (TX/RX)]; n78[3300-3800 MHz (TX/RX)] *4
LTE	B1[1920-1980 MHz (TX); 2110-2170 MHz (RX)]; B3[1710-1785 MHz (TX); 1805-1880 MHz (RX)]; B7[2500-2570 MHz (TX); 2620-2690 MHz (RX)]; B8[880-915 MHz (TX); 925-960 MHz (RX)]; B20[832-862 MHz (TX); 791-821 MHz (RX)]; B28[703-748 MHz (TX); 758-803 MHz (RX)]; B38[2570-2620 MHz (TX); 2570-2620 MHz (RX)]; B40[2300-2400 MHz (TX); 2300-2400 MHz (RX)]*3
3G	B1[1920-1980 MHz (TX); 2110-2170 MHz (RX)]; B8[880-915 MHz (TX); 925-960 MHz (RX)] *3
	Requirements in AT/BE/BG/CZ/DK/EE/FR/DE/IS/IE/IT/EL/ES/CY/LV/LI/LT/LU/HU/MT/NL/NO/PL/PT/RO/SI/SK/TR/FI/SE/CH/HR/UK(NI). 5150MHz-5350MHz is for indoor use only.

(*1: for 2.4GHz WLAN model; *2: for 5GHz WLAN model; *3: for LTE model; *4: for 5G-NR model)

This product is designed for 5G-NR, LTE, DSL and 2.4GHz /5GHz WLAN network throughout the EC region.

Hardware Installation

1. Connect the DSL interface to the land line jack with a DSL line cable, or Connect the cable Modem/DSL Modem/Media Converter to the WAN port of router with Ethernet cable (RJ-45).
2. Connect one end of an Ethernet cable (RJ-45) to one of the LAN ports of the router and the other end of the cable (RJ-45) into the Ethernet port on your computer.
3. Connect one end of the power adapter to the router's power port on the rear panel, and the other side into a wall outlet.
4. Power on the device by pressing down the power switch on the rear panel.
5. The system starts to initiate. After completing the system test, the ACT LED will light up and start blinking.

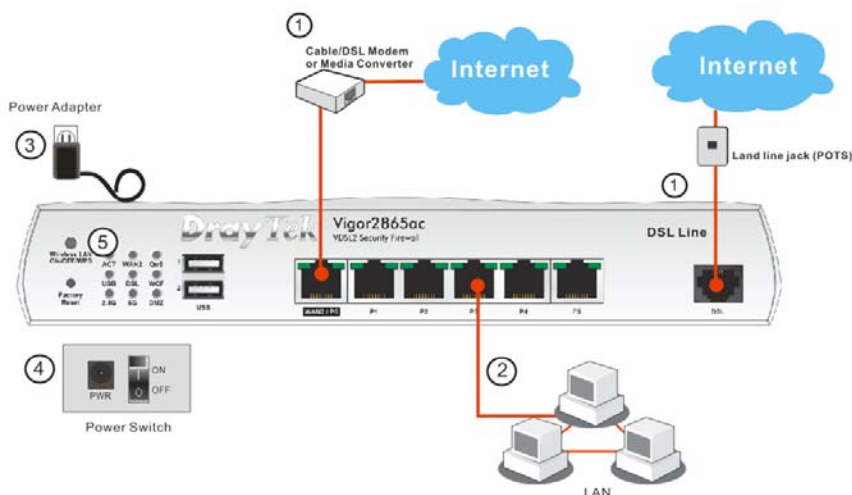

Wall-Mounted Installation

Vigor router has keyhole type mounting slots on the underside.

1. Drill two holes on the wall. The distance between the holes shall be 168mm.
2. Fit screws into the wall using the appropriate type of wall plug.

Note	The recommended drill diameter shall be 6.5mm (1/4").
-------------	---

3. When you finished about procedure, the router has been mounted on the wall firmly.

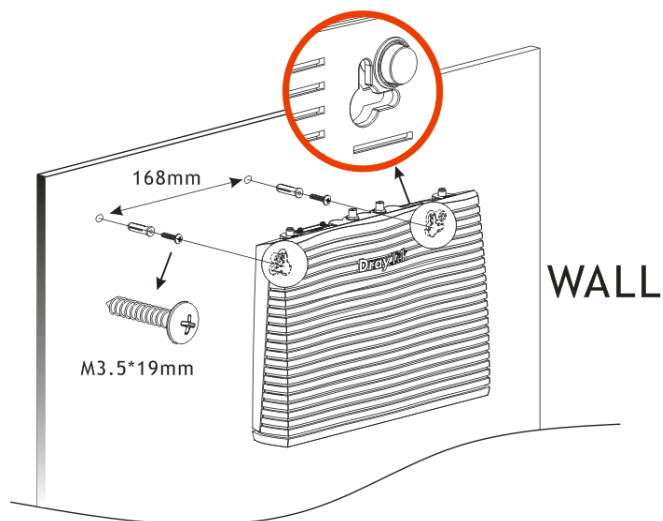

Antenna Installation

In this section, we take Vigor2865Lac as an example. There are two types of antennas provided for Vigor2865Lac, which must be installed in different locations carefully and correctly. Wrong installation might cause bad signal of wireless connection. Therefore, pay attention to the installation of antennas by referring to the following illustration.

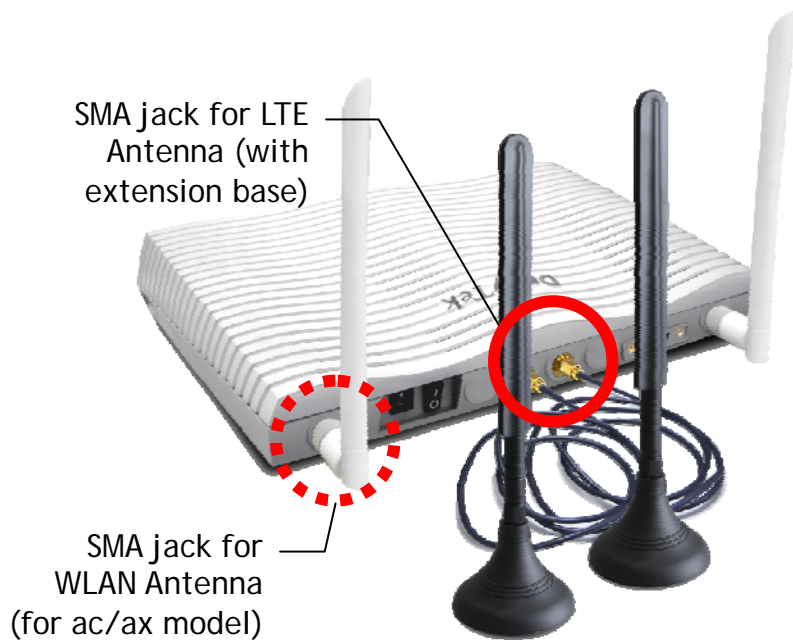

Magnetic antenna must be installed on the extension base before connecting to Vigor router.

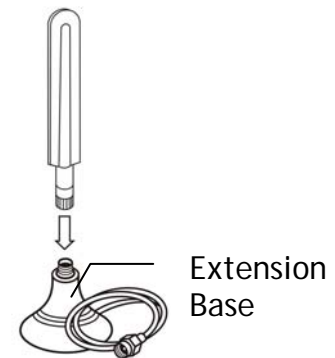

The number of antennas used for RF models will vary based on your model. For detailed information, refer to www.draytek.com.

Follow the steps below for installing the SIM card (for L model) into the card slot:

1. Assemble the extension base with the antenna.
2. While installing the SIM card into the card slot, note that the back plate of the SIM card slot must be removed first.
3. Assemble the SIM1 and SIM2 with the card cassette. Later insert the cassette into the SIM card slot and the direction of card notch must be on the left side.

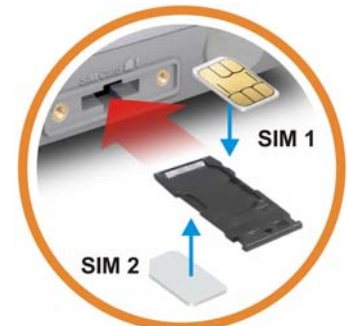

Software Configuration

Make sure your PC connects to the router correctly.

Open a web browser on your PC and type <http://192.168.1.1>. A pop-up window will open to ask for username and password. Please enter "admin/admin" as the Username/Password and click **Login**.

Then, the Main Screen will pop up.

